

Tube Connectors



Assembly Tools and Devices



Germany

Walter Stauffenberg GmbH & Co. KG

Im Ehrenfeld 4
58791 Werdohl

www.stauff.com

STAUFF products and services are globally available through wholly-owned subsidiaries and a tight network of authorised distributors and representatives in all major industrial regions of the world.

You can find detailed contact information on the last two pages of this product catalogue or at www.stauff.com/contact.

Please note: Unless otherwise stated, all data and figures in this product catalogue are approximate values and are only valid as references, which are not binding (also in respect to any third parties' rights of protection) and thus do not release the customer / user from checking and testing the suitability of the products for the foreseen purposes. Therefore, data and figures can only be used in a limited sense for construction purposes.

The application of the products is beyond the control possibilities of the manufacturer and, therefore, is exclusively subject to the responsibility of the customer / user.

In the event that a liability is nevertheless considered, any compensation will be limited to the value of the goods supplied by the manufacturer and used by the customer / user. As a matter of course, the manufacturer guarantees the perfect quality of all products in accordance with the General Terms and Conditions of Business and Sale.

Subject to modifications due to the ongoing development and improvement of the products.

With the publication of this product catalogue, previous editions are no longer valid.

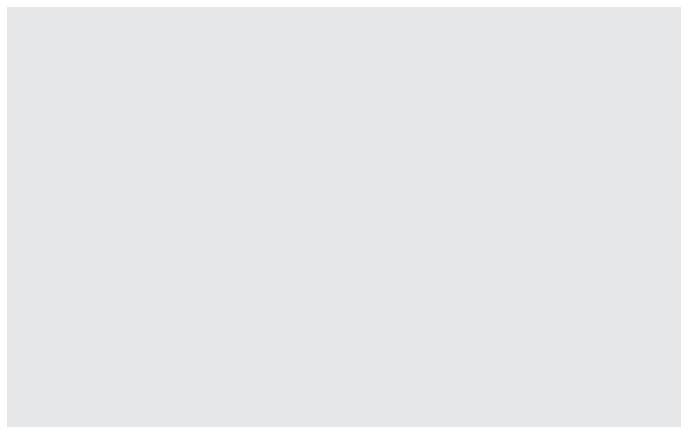
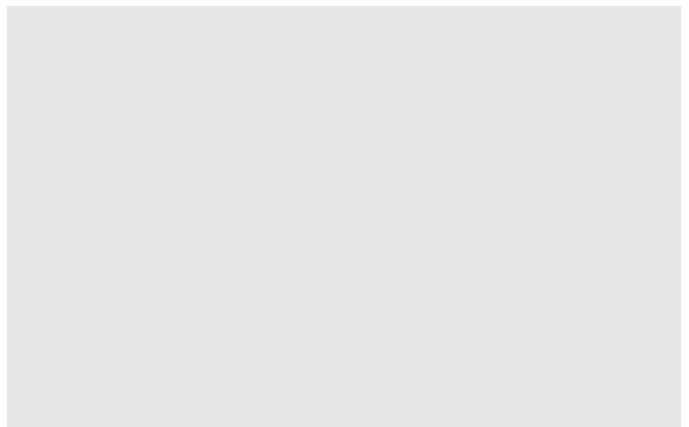

Introduction	4 - 11
System Overview	12 - 25
Connecting Parts	26 - 37
Male Stud Fittings	38 - 93
Tube Fittings / Unions	94 - 105
Bulkhead Fittings	106 - 111
Weld Fittings	112 - 121
Female Stud / Gauge Fittings	122 - 131
Fittings with 24° Taper / O-Ring (DKO)	132 - 153
Standpipe Fittings	154 - 169
Fittings with Lock Nut	170 - 179
Banjo Fittings	180 - 193
Swivel Fittings	194 - 197
Hydraulic Valves	198 - 217
Custom-Designed Solutions	218 - 221
Spare Parts / Accessories	222 - 247
Assembly Tools / Devices	248 - 279
Measuring and Test Equipment	280 - 283
Tube Manipulation	284 - 293
Assembly Instructions	294-327
Technical Appendix	329 - 343
Appendix (Product-Specific Abbreviations / Global Contact Directory)	344 - 351

A
B
C
D
E
F
G
H
I
J
K
L
M
N
O
P
Q
R
S
T





Catalogue 1 STAUFF Clamps

- Block Clamps
- Special Clamps
- Light Series Clamps
- Saddle Clamps
- U-Bolt Clamps
- Metal Clamps
- Construction Series



Catalogue 2 STAUFF Connect

- Tube Connectors
- Assembly Tools and Devices

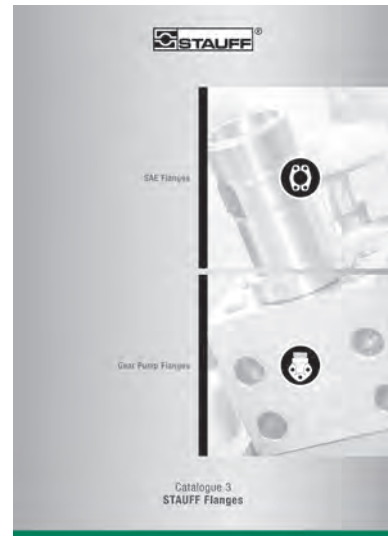

Catalogue 3 STAUFF Flanges

- SAE Flanges
- Gear Pump Flanges



Catalogue 4 STAUFF Hose Connectors

- Hose Connectors
- High-Pressure Hose Connectors



Catalogue 5 STAUFF Quick Release Couplings

- Push-to-Connect Couplings
- Multi Couplings
- Screw-to-Connect Couplings



Catalogue 6 STAUFF Valves

- Two-Way Ball Valves
- Multi-Way Ball Valves
- Flow Control and Check Valves
- Gauge Isolator Valves





Catalogue 7 STAUFF Test

- Test Couplings
- Test Adaptors
- Test Hoses and Connectors



Catalogue 8 STAUFF Diagtronics

- Pressure Gauges
- Hydraulic Testers
- Oil Analysis Equipment



Catalogue 9 STAUFF Filtration Technology

- Replacement Filter Elements
- Pressure Filters
- Return-Line Filters
- In-Line Filters
- Spin-On Filters
- Offline and Bypass Filters
- Filtration Systems

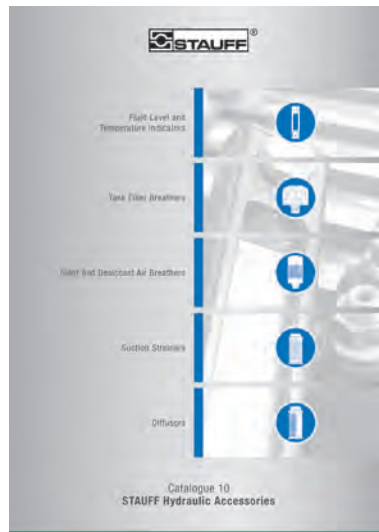

Catalogue 10 STAUFF Hydraulic Accessories

- Fluid Level and Temperature Indicators
- Tank Filler Breathers
- Giant and Desiccant Air Breathers
- Suction Strainers
- Diffusers



For more than 50 years, the companies of STAUFF Group have been developing, manufacturing and distributing pipework equipment and hydraulic components for mechanical and plant engineering and for service and industrial maintenance.

In addition to mobile and industrial hydraulic machinery, typical applications also include commercial and special purpose vehicles, rail transportation and energy technology. Likewise, STAUFF products are used in marine, oil and gas applications and in the process, food and chemical industries.

The overall range currently includes about 50000 standard products as well as numerous special and system solutions according to customer's specifications or based on our in-house development.

All STAUFF products undergo relevant testing in accordance with international regulations and are governed by the high standards of the in-house quality management system. Furthermore, many items have received certifications and approvals from various international institutes, organisations and authorities who have independently confirmed the quality and performance of the products.

Wholly-owned manufacturing, sales and service facilities in 18 countries and a tight global network of authorised distribution partners ensure high presence and service paired with a maximum of availability.



Quality Management – ISO 9001:2015
Environmental Management – ISO 14001:2015
Safety Management – ISO 45001:2018
Energy Management – ISO 50001:2018

STAUFF LINE Components

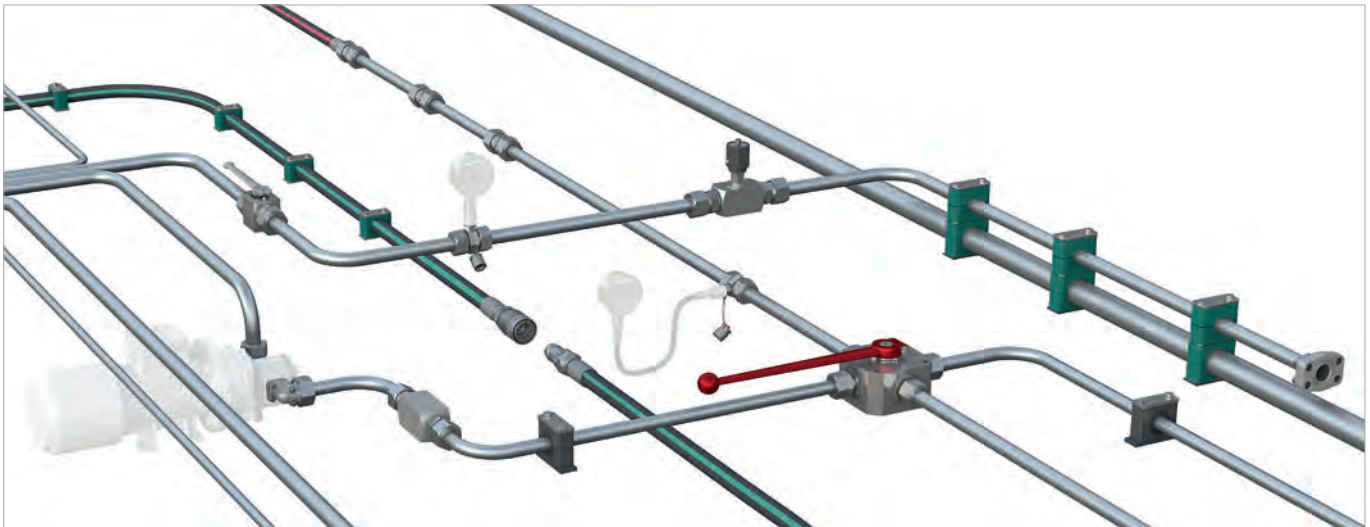

STAUFF Line

- STAUFF Clamps
- STAUFF Connect
- STAUFF Flanges
- STAUFF Hose Connectors
- STAUFF Quick Release Couplings
- STAUFF Valves
- STAUFF Test

from own, in-house development and manufacturing, the companies of the STAUFF Group provide a comprehensive range of components for fastening and connecting pipes, tubes and hoses for mobile and industrial hydraulic applications and many other industries.

The portfolio is completed by components for shutting-off, regulating, throttling and measuring fluid media.

In order to perfectly match each other, STAUFF Line products are designed and offered on a high, uniform level of quality. A large proportion of the range made from steel comes as standard with the premium STAUFF Zinc/Nickel surface coating, which is also optionally available for many of the other components.

This coating offers the most reliable surface protection far beyond the previous market standards – even after transport, handling and assembly of the components – and meets all current legal requirements.

If desired, Original Equipment Manufacturers can be supported with value-added services, from **technical consultation to pre-assembly, assembly and kitting** as well as **logistics services**:

- Support with the **selection of suitable standard components** and ordering options; provision of **customised solutions** according to customer's specifications or based on our in-house development – from prototyping to large scale production
- **Analysis and optimization** of existing and design and developments of new systems aimed at increasing the efficiency and performance of machines and equipment and creating value for customers by reducing the total cost
- **Pre-assembly, assembly and kitting** of individual components to customer-specific system modules
- Individually coordinated **procurement solutions** (e.g. web shop and electronic data interchange) and **supply models** (e.g. from warehousing of customised components to Kanban logistics and just-in-time delivery of pre-fabricated system modules to the assembly lines of the customers) aimed at optimising material flows



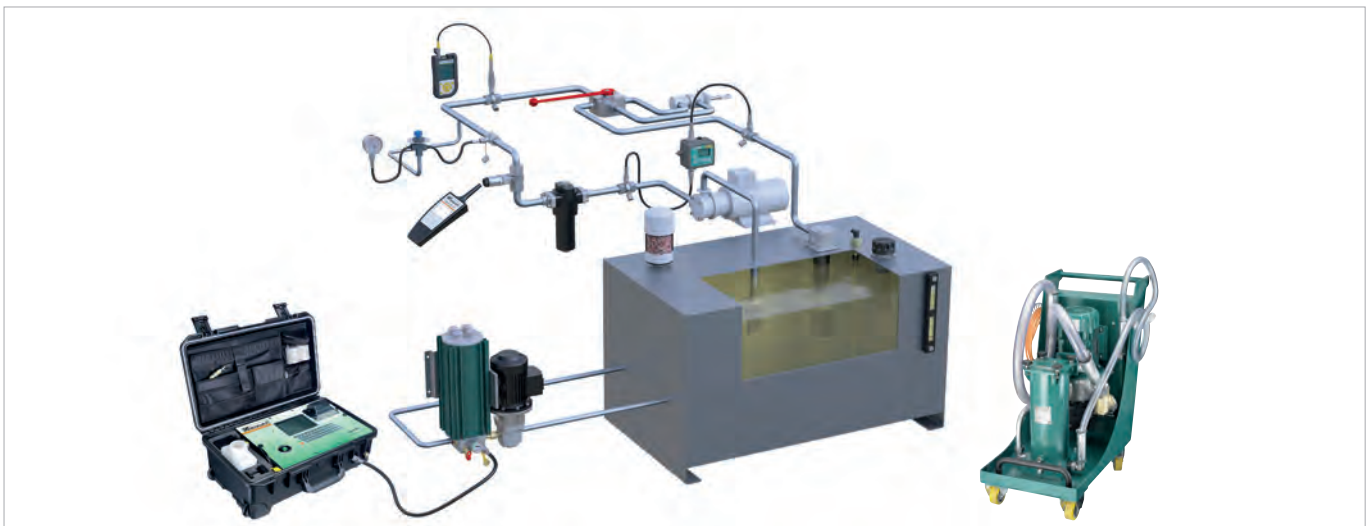

Aligned with the needs of the market, the product groups

- **STAUFF Test**
- **STAUFF Diagtronics**
- **STAUFF Filtration Technology**
- **STAUFF Hydraulic Accessories**

include a comprehensive range of analogue and digital measuring equipment and devices, filtration systems and replacement filter elements as well as accessories for the construction of tanks, reservoirs, power packs and gear boxes in mobile and industrial hydraulics.

The offer is completed by relevant value-added services:

- Support with the **selection of suitable components** and ordering options; provision of **customised solutions** according to customer's specifications or based on our in-house development – from prototyping to large scale production
- Analysis of existing hydraulic circuits aimed at filtration systems, tank components and monitoring devices that perfectly match to the specific requirements, and developing integrated concepts to increase the efficiency and performance of machines and equipment
- Individually coordinated **procurement solutions** and **supply models**



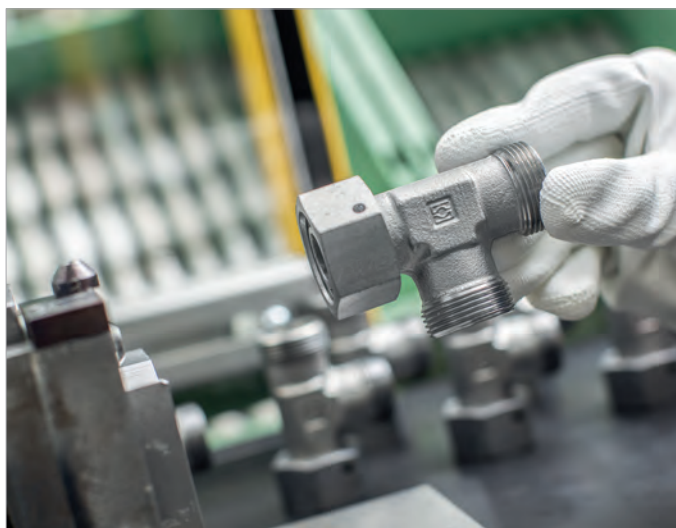

STAUFF Connect

The STAUFF Connect product group is closely aligned with the market requirements and contains an extensive range of tube connectors made of carbon steel for metric tubes with outer diameters ranging from 4 to 42 mm in accordance with ISO 8434-1 / DIN 2353:

- 24° cutting ring fittings
- 24° taper fittings with O-ring
- 24° weld cones with O-ring
- 37° flared tube fittings

The product range is completed by check and alternating valves for inline installation, thread reducers as well as blanking plugs and screws.

Special product types and sizes as well as alternative materials, material combinations and surface coatings deviating from the standards can be supplied on request.

Automated assembly machinery and hardened, wear-resistant tools enable the reliable assembly of tube connectors – both for series production in the workshop and on-site.

Because of its versatility and flexibility, the patented STAUFF Form Tube Forming System is undoubtedly the best solution for series production, in particular for applications with highest requirements with regards to safety, reliability and repeatability as well as process stability.

For the finishing of the tube connector range in carbon steel, STAUFF relies on the STAUFF Zinc/Nickel surface coating which has proven successful for many years. It provides reliable surface protection – even after transport, handling and assembly – and meets all current legal requirements.

For selected types and series, independent certificates and approvals can be provided:

- Bureau Veritas
- DNV GL
- DVGW
- Lloyd's Register





STAUFF Zinc/Nickel Coating



Layers

- Sealing
- Passivation
- Zinc/Nickel
- Steel

With at least 1200 hours resistance against red rust, the STAUFF Zinc/Nickel surface coating offers excellent surface protection – even after transport, handling and assembly. This was confirmed by testing in the salt-spray chamber according to DIN EN ISO 9227.

Users across all industries and applications benefit from sophisticated technology, which has been developed for and used by the very demanding automotive industry for many years now and that is already the proven standard for a large proportion of STAUFF components since 2007.

- At least 1200 hours resistance to red rust / base metal corrosion under practical conditions in the salt-spray chamber according to DIN EN ISO 9227
- White rust occurs only by way of a slight grey haze
- Surpassing the requirements of the corrosion protection class K5 as defined by the VDMA, the German Engineering Association (360 hours resistance to white rust / 720 hours resistance to red rust)
- Free of hexavalent chrome Cr(VI)
- ELV compliant according to 2000/53/EC (End of Life Vehicles Directive)
- REACH compliant according to 1907/2006/EC (Registration, Evaluation, Authorisation and Restriction of Chemicals)
- RoHS compliant according to 2002/95/EC (Restrictions of the Use of Hazardous Substances)
- Appealing colour scheme with a bright semi-gloss surface finish – comparable to Stainless Steel
- Significantly reduced tendency to corrosion by contact with other metals (such as Aluminium and Stainless Steel)
- Improved abrasion resistance due to the ductility / plastic deformability of the coating
- Little to no risk of triggering allergies – nickel release is down to only a fraction of the statutory limits relating to objects which come into direct and prolonged contact with the skin (independent results of the reference test method according to DIN EN 1811 are available on request)
- Good paint adhesion properties
- Resistance against all commonly used hydraulic media





www.stauff.com/catalogues

The STAUFF online catalogue centre at www.stauff.com/catalogues provides fast and direct access to digital versions of this as well as other STAUFF product catalogues in all available languages.

Online Page-Flip Catalogues

- Easy navigation through index or the powerful full text search functionality
- Contents can be shared and forwarded by e-mail, printed or downloaded and saved in PDF file format
- Also suitable for mobile devices

Download Catalogues

- Download entire product catalogues and save them in PDF file format

The fastest way to the online page-flip catalogue:

The links that can be found at the bottom edge of all pages of this product catalogue will lead you directly to the corresponding page in the online page-flip catalogue.

In doing so, contents can be searched, shared and forwarded by e-mail, printed or downloaded and saved in PDF file format.

Scan the QR code next to the direct link with the camera of your mobile device* and also use the functions in this way.

* may require a suitable app





www.stauff.com

With the STAUFF Digital Platform available at www.stauff.com, commercial customers and users of STAUFF products can not only inform themselves in all detail about the 50000 components typically available from stock, but also directly purchase these online without complex registration.

General information about the companies of STAUFF Group, latest business and product news as well as complete global contact details also be available.

www.stauff.com/cad

Immediate access to and free download of 3D models and 2D drawings for a growing number of STAUFF products

www.filterinterchange.com

Online database for the quick and easy identification and interchange of almost all common brands and types of replacement filter elements

Main Functionalities of the STAUFF Digital Platform:

- Around the clock**
Check stock availability and pricing for STAUFF products in real time
- Cross references and comparative designations**
Search by article designations of other manufacturers / suppliers
- Live chat**
Get directly in touch with the STAUFF customer service and sales team
- CAD database**
Download 3D models and 2D drawings for STAUFF products

Advantages as a Registered User of the STAUFF Digital Platform:

- Purchase STAUFF products**
Taking customer-specific pricing and delivery conditions into account
- Ordering w/o searching**
Quick ordering by entering article number, quantity and requested delivery date
- File upload**
Direct upload of orders with multiple positions in CSV or Excel file format
- Notepad function**
Create project lists to save interesting products for later

Follow STAUFF and keep yourself updated:

LinkedIn
www.linkedin.com/company/stauff

Youtube
www.youtube.com/stauffgroup

STAUFF Newsletters
Automatic e-mail notifications about latest news from STAUFF
www.stauff.com/newsletter





24° Tube Fittings in General	14
24° Tube Fittings with Single / Double Edge Cutting Ring	16
24° Tube Fittings with Soft-Sealing Cutting Ring	17
Tube Fittings with 24° Taper / O-Ring (DK0)	18
24° Weld Cones with O-Ring	19
24° Tube Fittings using the STAUFF Form EVO Tube Forming System	20
37° Flared Tube Fittings	22
Overview of 24°- Tube Fittings (ISO 8434-1 / DIN 2353)	24



24° Tube Fittings in General

A

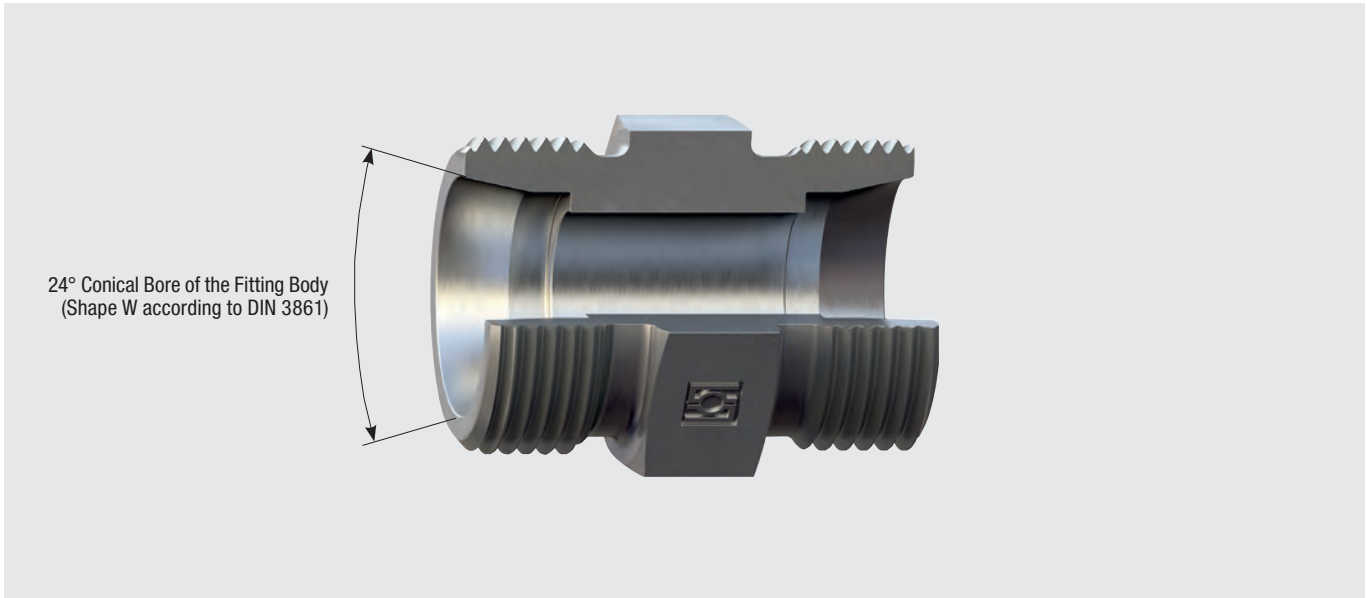

24° Tube Fittings are surely among the most commonly used and established industrial tube connector systems worldwide. They are regarded as the universal standard for fluid power applications in markets that use the metric system, such as Europe, Asia, Africa and South America.

Even in regions that traditionally used or still use the imperial measurement system (such as Australia or Northern America) 24° tube fittings are gaining more and more acceptance due to the ongoing metrification and specifications by globally operating OEMs.

24° Tube Fittings are specified in the ISO 8434-1 and DIN 2353 standards.

At least one tube connection end of the fitting body is characterized by a 24° conical bore (shape W according to DIN 3861), which serves as a metallic sealing surface, while the other end of the body is available with a variety of different connection types, such as male and female threaded or weld studs.

Various shapes (e.g. straight fittings, elbows, tees, crosses etc.) and designs (e.g. unions, studs, bulkheads or adjustable fittings) are available.

The portfolio consists of the Extra-Light (LL) Series as defined in the DIN 2353 standard as well as the Light Series (L) and the Heavy Series (S) as defined in the ISO 8434-1 standard, which differ from each other in particular with regards to their dimensions and pressure ratings.

Main Advantages of the 24° Tube Fitting System

- 24° Tube Fittings can be quickly and easily field-assembled and even re-assembled with just a couple of standard wrenches and no requirement for hours of expensive staff training or special tube treatment. Under regular conditions, subsequent re-tightening of 24° Tube Fittings is not necessary.
- Most types of 24° Tube Fittings are available and suitable for light, medium, heavy and extra-heavy wall tubing with outside diameters ranging from 4 to 42 mm, which allows optimum dimensioning of pipework circuits and saves material cost.
- The 24° Tube Fitting System is available in the Extra-Light (LL), the Light (L) and the Heavy (S) Series and provides suitable components with regards to sufficient pressure ratings and maximum leak-tightness up to nominal pressures of 800 bar (depending on series, type and size of the component – pressure reduction factors to be considered) for literally each application.
- Thanks to their optimised inner contour and design, 24° Tube Fittings offer ideal flow rates and therefore guarantee best performance without the excessive generation of vibrations, noise or heat.
- 24° Tube Fittings are small and compact in design compared to other systems, which makes them perfect for applications with space considerations.
- The recommended material raise in front of the first edge of the cutting ring after the assembly is clearly visible to tube fitters and inspectors and makes it easy to check and confirm the correct assembly of 24° Tube Fittings.
- On-site piping with 24° Tube Fittings is very efficient and offers maximum flexibility for tube fitters as the exact required tube length can be easily checked in advance by just trying out.
- 24° Tube Fittings are easy to combine with other tube fitting systems – even hoses can be connected without difficulties.

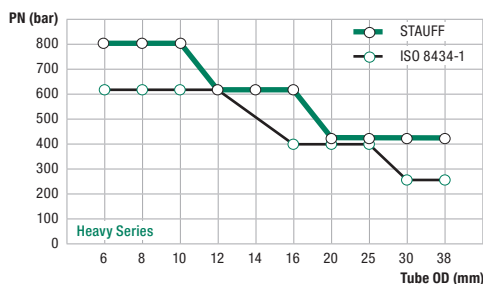
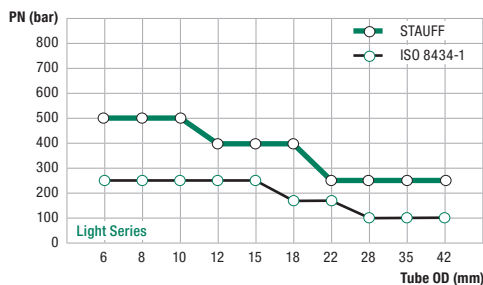

Nominal pressure levels of tube fittings



Overview of 24° Tube Fittings

A

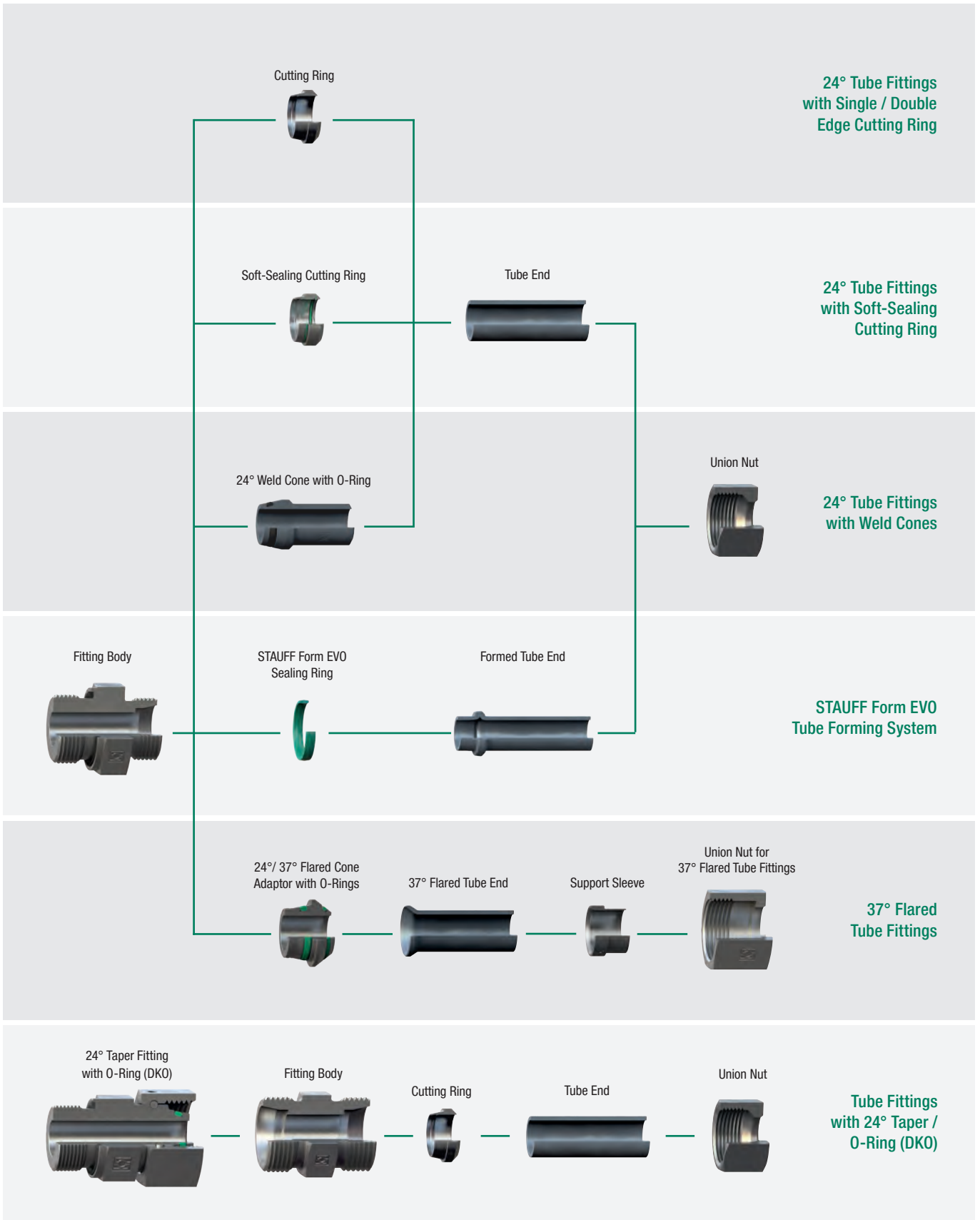

24° Tube Fittings with Single / Double Edge Cutting Ring

A

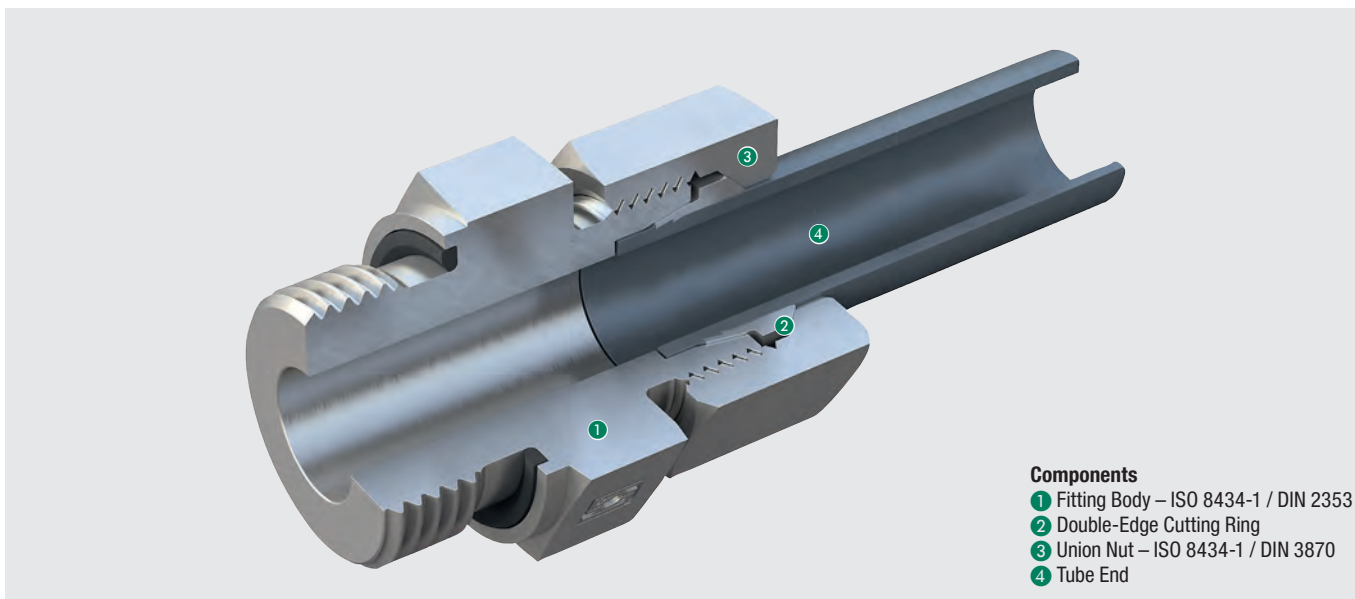

Components

- ① Fitting Body – ISO 8434-1 / DIN 2353
- ② Double-Edge Cutting Ring
- ③ Union Nut – ISO 8434-1 / DIN 3870
- ④ Tube End

The operating principle of STAUFF Connect 24° Tube Fittings with Cutting Ring is based on a double-edge cutting ring, which cuts into the tube twice, thus ensuring the necessary force and form closure in the cutting area.

Thanks to the optimised geometry of this ring, the two edges do not cut simultaneously, but rather one after the other. In addition to increasing the incising effect, this method maximises the tear strength of the fitting.

Due to the design of the double-edge cutting ring in the central region as well as in the shoulder area, a larger tube support surface with a high surface pressure is achieved without jamming the cutting ring. This ensures uniform distribution of force. The outer support surfaces of the cutting ring are smoothed, thus minimising friction losses during assembly and guaranteeing the maximum degree of safety during use.

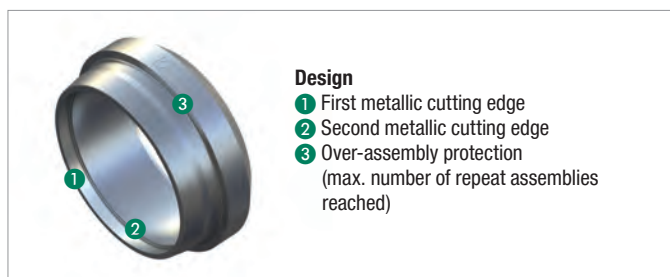

Design

- ① First metallic cutting edge
- ② Second metallic cutting edge
- ③ Over-assembly protection (max. number of repeat assemblies reached)

Features

- 100% final Assembly
- Only 30° final tightening after the noticeable increase in force (repeatability significantly)
 - Increase in process reliability due to lower error potential during final tightening compared to DIN 3859-2
- Over-assembly protection (indication of the last possible assembly)
- Proven 2 cutting edge technology (Metallic sealing)
- Up to 500 bar in the light series and Up to 800 bar in the heavy series
- High-quality STAUFF zinc/nickel surface
 - cuts into stainless steel and serves as an insulator between steel and stainless steel
 - no contact corrosion
 - Rust resistance higher than VDMA K5 class (720h according to DIN EN ISO 9227)



24° Tube Fittings with Soft-Sealing Cutting Ring

A

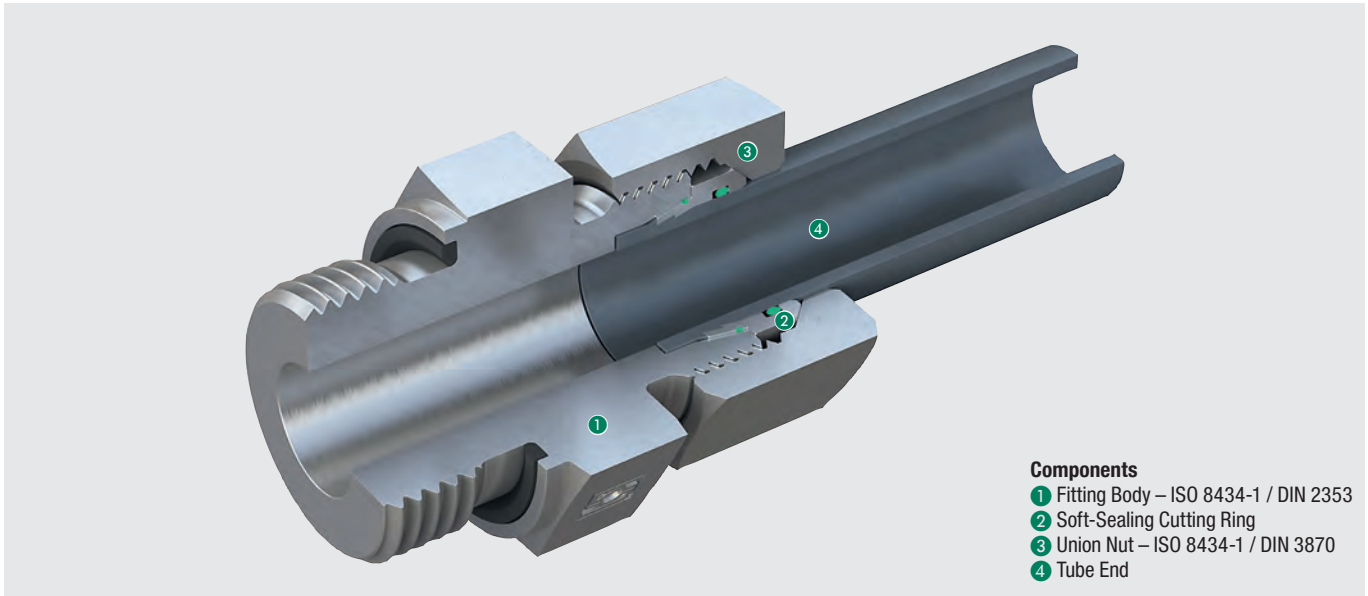

- Components**
- ① Fitting Body – ISO 8434-1 / DIN 2353
 - ② Soft-Sealing Cutting Ring
 - ③ Union Nut – ISO 8434-1 / DIN 3870
 - ④ Tube End

Soft-Sealing Cutting Rings provide an additional safety and protection against potential leakage risks, e.g. caused by the settling of purely metallic sealed connections, temperature fluctuations or considerable pressure and vibration loads in the system. "Sweating effects" on the connection points can be permanently avoided.

The type FI-WDDS Soft-Sealing Cutting Ring of the STAUFF Connect range is characterised by the elastomer sealing, which is located in a specially designed groove close to the rear end of the 24° taper and protected to prevent loss. An additional o-ring is used to secure the second potential leakage path between the cutting ring and the tube – even in the event of unfavourable tolerances

FKM (Viton®) is used as the standard sealing material and enables problem-free use of the system for challenging applications involving high temperatures or aggressive media.

Both elastomer sealings are located in the secondary sealing zone of the connection. Static and dynamic loads in the system are primarily compensated by the tried and tested metallic sealed area. When assembled, the soft-sealing elements are almost completely chambered (as gap-free and cavity-free as technically possible). This prevents extrusion of the sealings and contributes to the excellent longterm stability of the system.

Type FI-WDDS Soft-Sealing Cutting Rings convince through their simple assembly in the fitting body: Use a suitable spanner to tighten the union nut until the point where the cutting ring comes into contact and sits closely with the face side of the fitting body. This point is characterised by a significant increase in force.

Due to the design, the risks of insufficient assembly as well as over-assembly of cutting rings (which can lead to damage or radial constriction of thin-walled tubes) can be significantly reduced.

As a matter of course, the recommended material raise in front of the first edge of the cutting ring after the completed assembly is clearly visible to tube fitters and inspectors and makes it easy to check and confirm the correct assembly – as required by the norm.

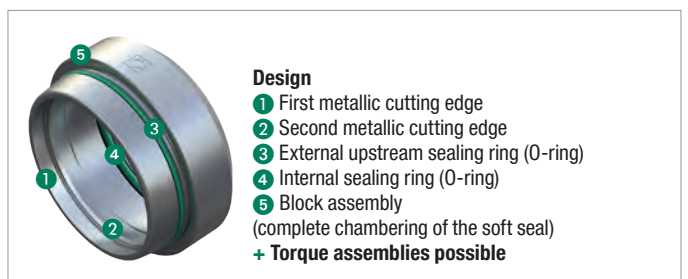
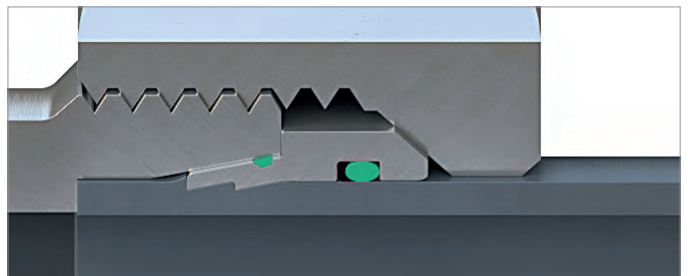

Features

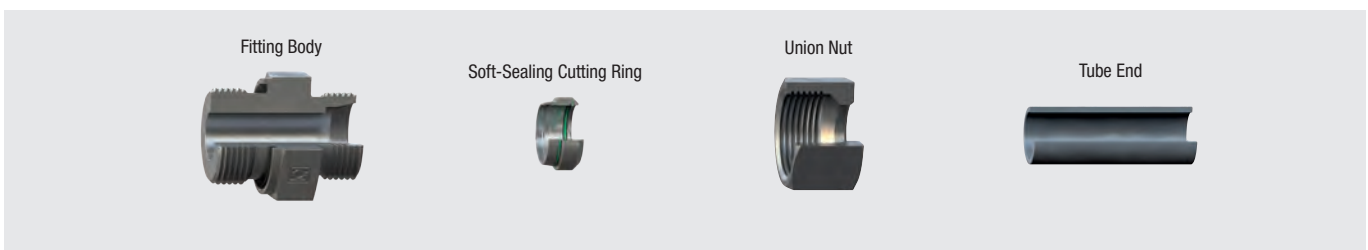
- 100% final Assembly
- Upstream and fully chambered soft seals in the secondary area (no pressure peaks directly at the seals, long-lasting)
- Increase in process reliability due to lower error potential in the final suit compared to DIN 3859-2
 - Torque mounting possible (block mounting)
 - Final tightening to the tightening limit (block). Approx. 90°-150°
- Proven 2 cutting edge technology
 - Primary metallic sealing, secondary soft sealing
 - Minimises possible error potential
 - Serves as feedback of the assembly finish
- Up to 500 bar in the lighter series and Up to 800 bar in the heavy series
- Available in steel with high quality STAUFF zinc/nickel surface and in stainless steel

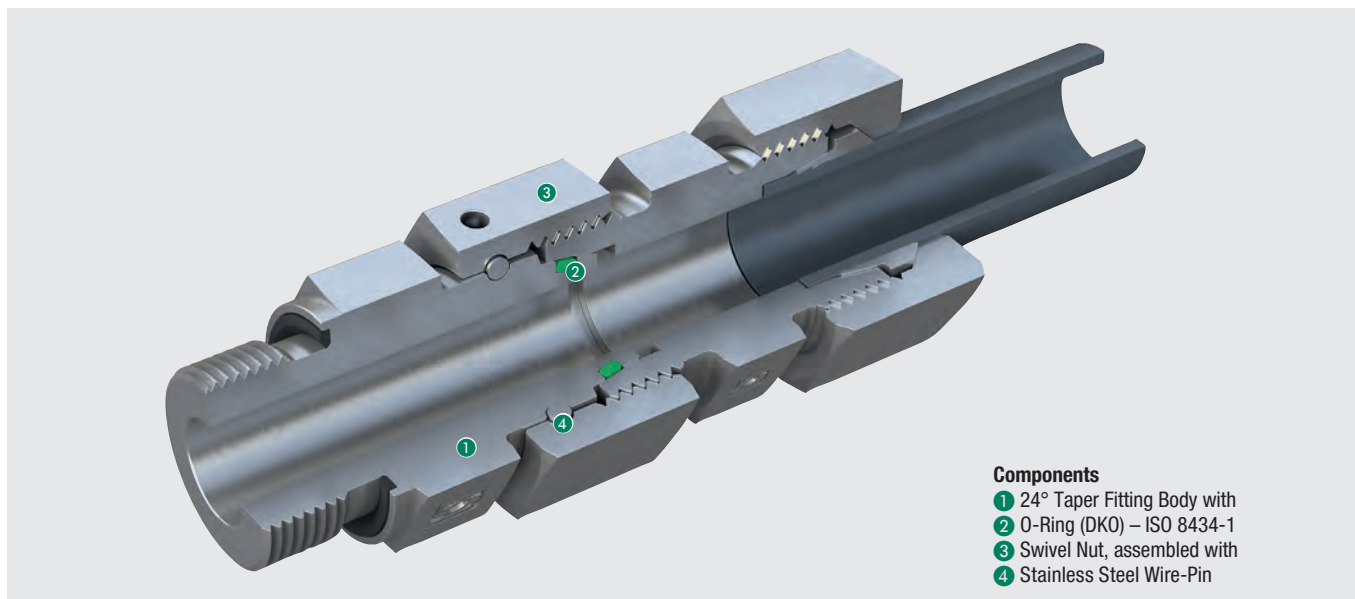

Tube Fittings with 24° Taper / O-Ring (DKO)

A



Components

- ① 24° Taper Fitting Body with
- ② O-Ring (DKO) – ISO 8434-1
- ③ Swivel Nut, assembled with
- ④ Stainless Steel Wire-Pin

Due to the 24° taper (with o-rings) located on the fitting body itself, STAUFF Connect Tube Fittings with 24° Taper / O-Ring (DKO) represent a logical further development of traditionally available adjustable standpipe tube fittings with factory-assembled cutting rings and union nuts.

The retention function is assured by a special swivel nut with a wire-pin located in a groove, which is factory-assembled by the manufacturer.

The embedded o-ring on the 24° taper ensures a high level of protection against leakage.

Thanks to the large number of available types and designs, almost all common types and combinations of adjustable fittings can be implemented.

With regards to their dimensioning and general design, STAUFF Connect Tube Fittings with 24° Taper / O-Ring (DKO) fully comply with the latest versions of the ISO 8434-1 standard. They are thus completely interchangeable with conventional adjustable standpipe tube fittings.

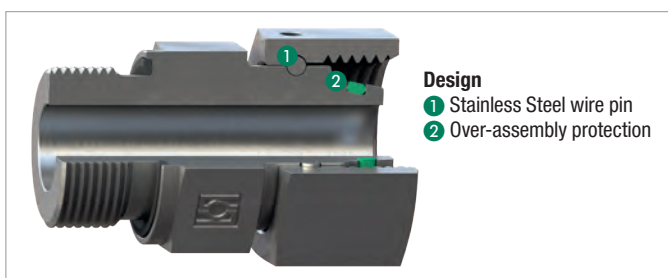

Design

- ① Stainless Steel wire pin
- ② Over-assembly protection

Features

- Process reliability
 - Same final tightening of 120° for all sizes
 - No lubrication of threads required
- Stainless Steel wire pin
 - No setting of the wire pin
 - does not distort the angle of rotation during final tightening
- Smooth running nut
- Torque mounting possible
- Over-assembly protection

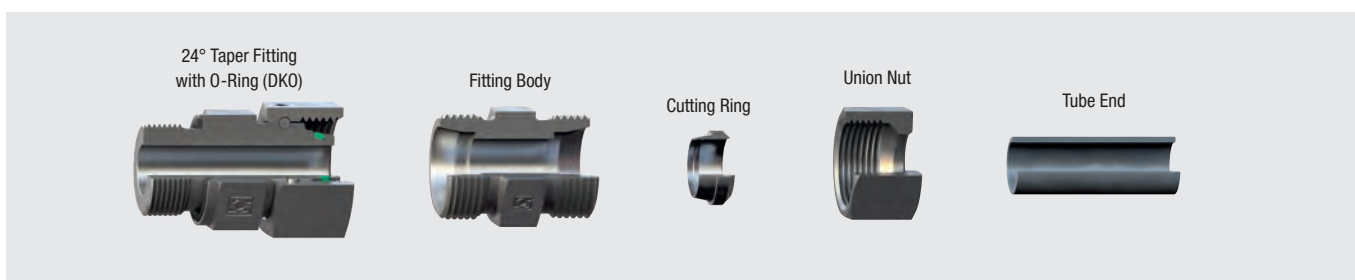

24° Taper Fitting
with O-Ring (DKO)

Fitting Body

Cutting Ring

Union Nut

Tube End



24° Weld Cones with O-Ring

A

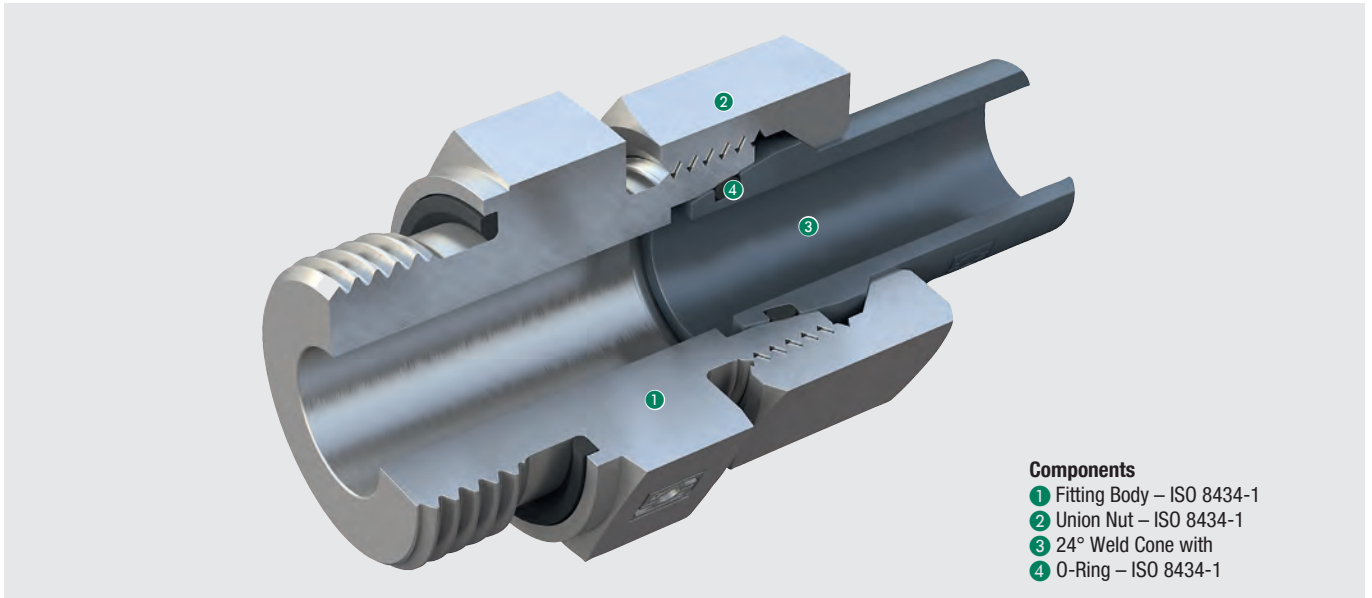

Components

- ① Fitting Body – ISO 8434-1
- ② Union Nut – ISO 8434-1
- ③ 24° Weld Cone with
- ④ O-Ring – ISO 8434-1

STAUFF Connect 24° Weld Cones with O-Ring represent a supplement to the usual range of tube fittings. However, they are increasingly perceived as a special solution due to the complex tube preparation, assembly, finishing and testing, as are all other types of welded connectors.

STAUFF Connect 24° Weld Cones with O-Ring are directly welded to the tube end.

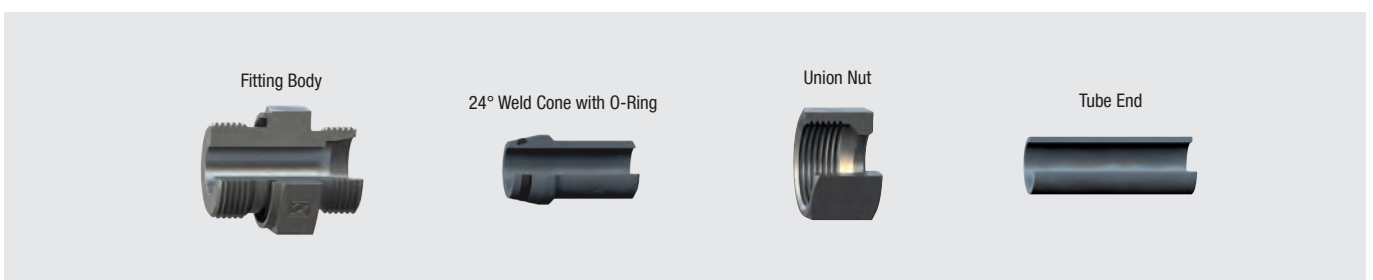
With regards to their dimensioning and general design, they fully comply with the latest versions of the ISO 8434-1 standard.



24° Tube Fittings using the STAUFF Form EVO Tube Forming System

A

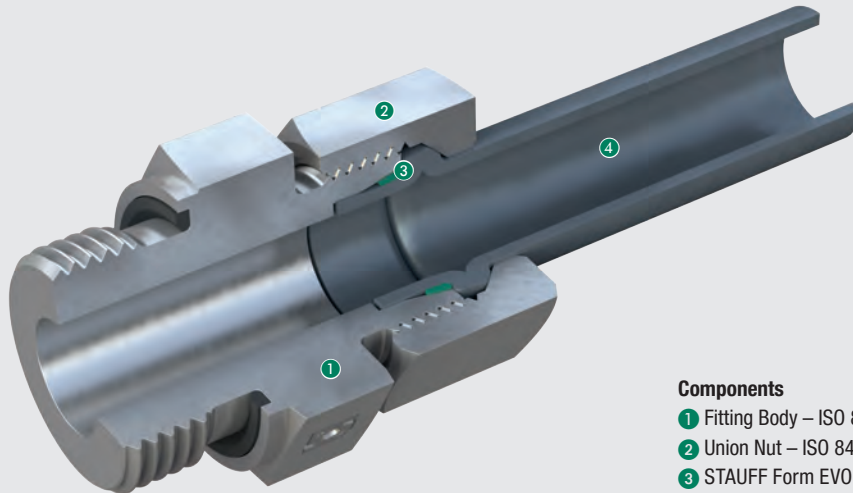

Components

- ① Fitting Body – ISO 8434-1
- ② Union Nut – ISO 8434-1
- ③ STAUFF Form EVO Sealing Ring
- ④ Formed Tube End

Performance

The STAUFF Form tube forming system was first presented in 2015. Since the beginning it has undoubtedly been one of the most efficient solutions available on the market for connecting metric tubes. In addition to its simplicity, it convinces with a high degree of safety, reliability and reproducibility.

With STAUFF Form EVO, STAUFF now presents the latest generation of the tube forming system, which is characterised by an increased level of efficiency and versatility as a result of continuous optimisation.

STAUFF Form EVO has been designed as standard for seamless cold-drawn precision steel tubes as well as stainless steel tubes with dimensions between 6 x 1.5 mm and 42 x 4 mm in the Light Series and between 6 x 1.5 mm and 38 x 6 mm in the Heavy Series. If required, parameters for alternative materials are available upon request and can be added by the manufacturer or via the optional cloud connection module integrated in the machines.

System Design and Components

The system is based on standard parts and consists of only four key components:

The STAUFF Form EVO Sealing Ring is slid onto the tube end, which has previously been mechanically contoured. This creates a positive-locking connection that provides a reliable, permanent and maintenance-free seal when used with a conventional fitting body with 24° conical bore and a union nut, both according to ISO 8434-1.

Versatility and Flexibility

Users benefit from the great versatility and flexibility of the system, as well as the many combination and adaptation options offered by using standard components from the STAUFF Connect product range.

There is therefore no need to duplicate the stock-keeping of similar components with a correspondingly high likelihood of confusion, as is often the case with comparable systems. Material and logistics costs can thus be correspondingly reduced.

Materials and Surface Finishing

All components in the STAUFF Connect product range are designed as standard with a high-quality zinc/nickel surface coating.

With over 1,200 hours of resistance to red rust / base metal corrosion in the salt-spray chamber in accordance with DIN EN ISO 9227, the coating offers most reliable corrosion protection far beyond previously accepted market standards.

Even after shipping, handling and assembly of the components, the coating significantly exceeds the requirements for the highest corrosion protection class K5 defined in VDMA Standard Sheet 24576 for tube connectors.

Sealing

The sealing of the only possible leakage path is provided primarily by the large-volume elastomeric sealing of the STAUFF Form EVO Sealing Ring which is specifically positioned between the surface of the tube and the 24° conical bore of the fitting body during assembly.

FKM (Viton®) is used as the standard sealing material and enables problem-free use of the STAUFF Form EVO tube forming system for challenging applications involving high temperatures or aggressive media.

Thanks to the combined metal-elastomer sealing, the usage of the system in low-temperature ranges down to -35° C is possible without restriction – as is also the case with NBR (Buna-N®).

The unique sealing profile has a particularly large cross-section in order to seal securely and permanently, even in the event of unfavourable tolerances of the tube or the tube fitting. Possible errors during assembly on the formed tube end are consistently avoided by the laterally equal profile of the sealing ring. The sealing effect is supported by the system pressure of the hydraulic system, so that the STAUFF Form EVO tube forming system is perfectly suited for high-pressure applications.

Fitting Body



STAUFF Form EVO Sealing Ring



Formed Tube End



Union Nut



Features

Design

- Based on standard components including the standard union nut of the STAUFF Connect product range according to ISO 8434-1 – No duplicate storage of similar stocking of similar components with a correspondingly high risk of confusion
- Positive-locking connection with an elastomer sealing with a particularly large cross-section to provide secure and permanent sealing even in the event of unfavourable tolerances
- Sealing of the only possible leakage path primarily via the STAUFF Form EVO sealing ring as well as the secondary, face sealing
- Preservation of the flow behaviour through the optimised shape of the formed tube end

Assembly Tools and Devices

- Robust table-top device for continuous operation in the workshop
- High efficiency of the system with low cycle times
- Optimum tool concept with exchangeable internal tube supports, so that only a small number of tools is required to cover all tube diameters
- Intuitive operation via touchscreen
- Cloud connection as well as machine briefings and trainings
- All tools needed for the forming process clearly labelled with the tube dimensions so that assembly errors caused by incorrect assignment can be largely ruled out
- Short times required for tool changes as clamping jaws, tube shaper and internal tube supports can be simply replaced without the need for any tools
- Attractive maintenance packages to ensure best possible service
- Low insertion depths compared to alternative systems for even more complex tube geometries and smaller bending radii

Durability and Application

- Suitable for both steel and stainless steel tubing as standard – also applicable for alternative tube materials on request
- Covers all common metric tube dimensions from 6 x 1.5 mm to 42 x 4 mm in the Light Series and 38 x 6 mm in the Heavy Series respectively
- Suitable for nominal pressures up to 800 bar in the Heavy Series – designed with four-fold safety and maximum tear-out strength
- The use of FKM (Viton®) as the standard seal material makes the system perfect for the most challenging applications. Thanks to the combined metal-elastomer seal, low-temperature ranges down to -35° C are possible without restriction
- High-quality zinc/nickel surface coating provides maximum protection and corrosion resistance – standard for all parts in the STAUFF Connect range

Final Assembly

- Incredibly simple final assembly in the fitting body with low assembly torques as well as short assembly paths (once the fixed point has been reached) with a minimised risk of over-assembly
- Assembly errors are consistently avoided due to the laterally identical profile of the sealing ring
- Connections can be untightened as often as required and reassembled without wear, as any damaging expansion of the 24° conical bore of the fitting body is technically avoided
- No need for time-consuming and expensive training

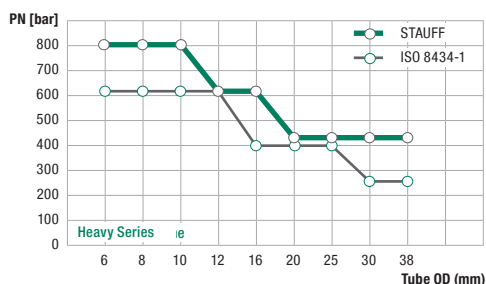
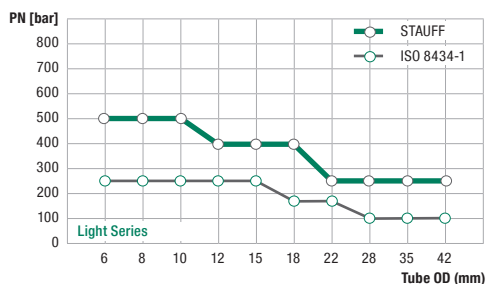

Nominal pressure levels of tube fittings

Pressure Resistance

When the STAUFF Form EVO tube forming system is used in conjunction with genuine products from the STAUFF Connect product range, it provides pressure resistance of up to 800 bar in the Heavy Series and 500 bar in the Light Series (generally with a four-fold safety factor and depending on the series, design and size of the fitting body and taking into consideration various pressure reducing factors).

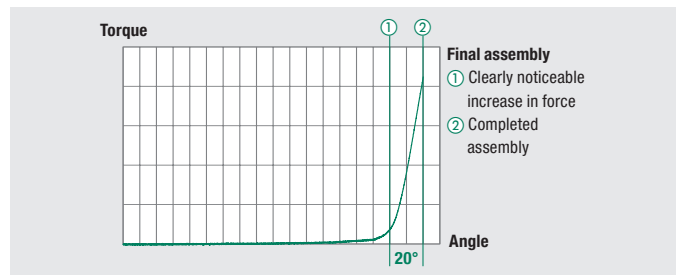

Final Assembly in the Fitting Body

Final assembly is performed by tightening the union nut until the point with clearly noticeable increase in force (fixed point). The assembly is completed with another turn by approximately 15° to 20° beyond this point.

This incredibly simple assembly method has several benefits for the user:

- Considerably lower torques and short assembly paths (once the fixed point has been reached)
- Significant increase in torque to clearly indicate the end of the assembly
- Maximum safety to combat over-assembly
- No need for time-consuming and expensive training

Connections made with the STAUFF Form EVO can be untightened as often as required and reassembled without wear, as any damaging expansion of the 24° conical bore of the fitting body is technically avoided.

This is the result of exceptional care taken in the development of the system and the selection, handling and processing of the raw materials.

Maximum tear-out strength can be guaranteed for the system due to the contour shaped at the tube end.



37° Flared Tube Fittings

A

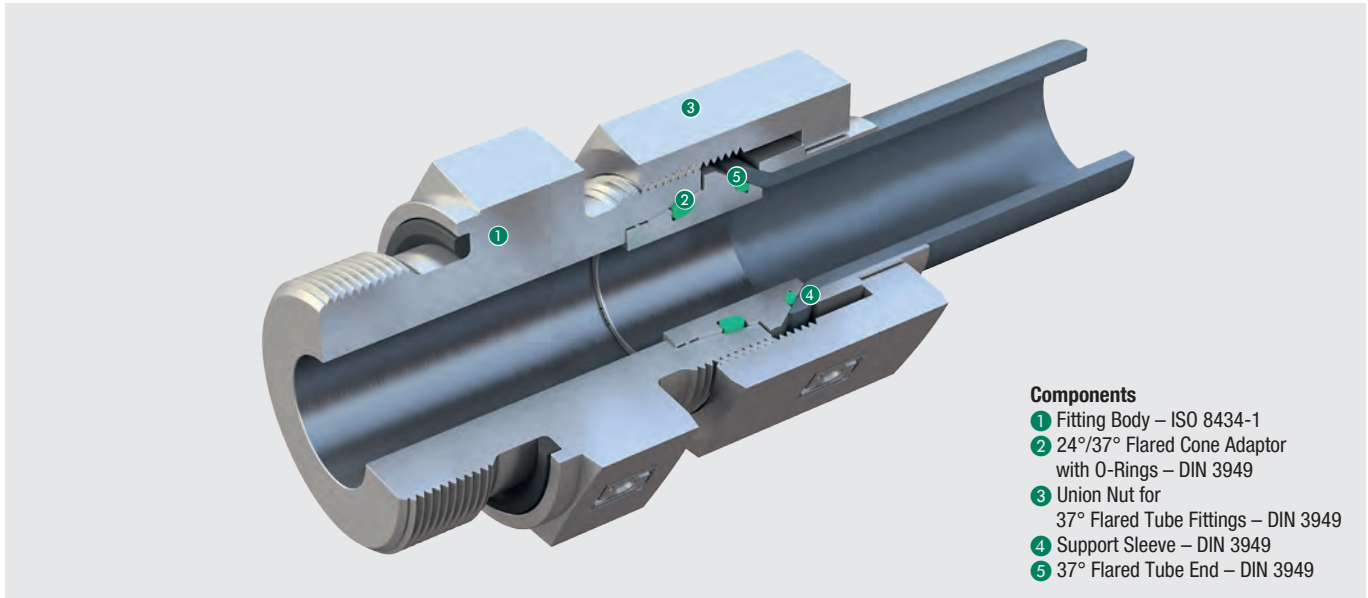

Components

- ① Fitting Body – ISO 8434-1
- ② 24°/37° Flared Cone Adaptor with O-Rings – DIN 3949
- ③ Union Nut for 37° Flared Tube Fittings – DIN 3949
- ④ Support Sleeve – DIN 3949
- ⑤ 37° Flared Tube End – DIN 3949

STAUFF Connect 37° Flared Tube Fittings have been developed and designed for the reliable, leak-free connection of tubes with a 37° flare with conventional fitting bodies with a 24° cone according to ISO 8434-1.

Thanks to the optimised geometry of STAUFF Connect 37° Flared Tube Fittings with metallic/elastomer sealing at the contact points both to the fitting body and the tube, efficient sealing is ensured, even if there are vibrations and pressure fluctuations / peaks.



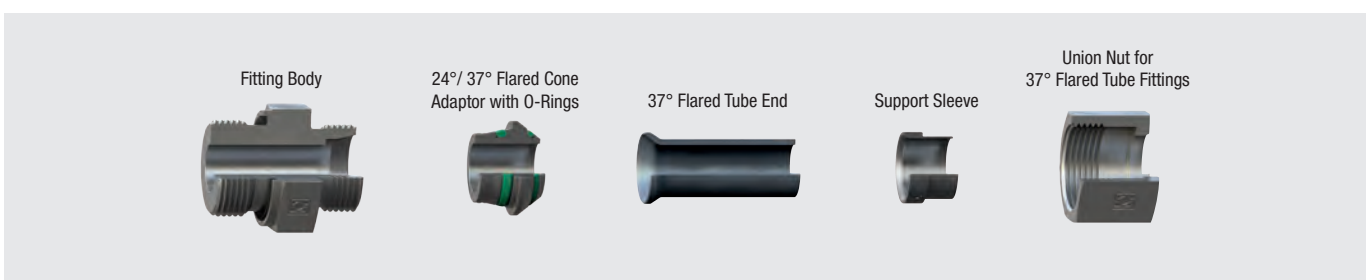

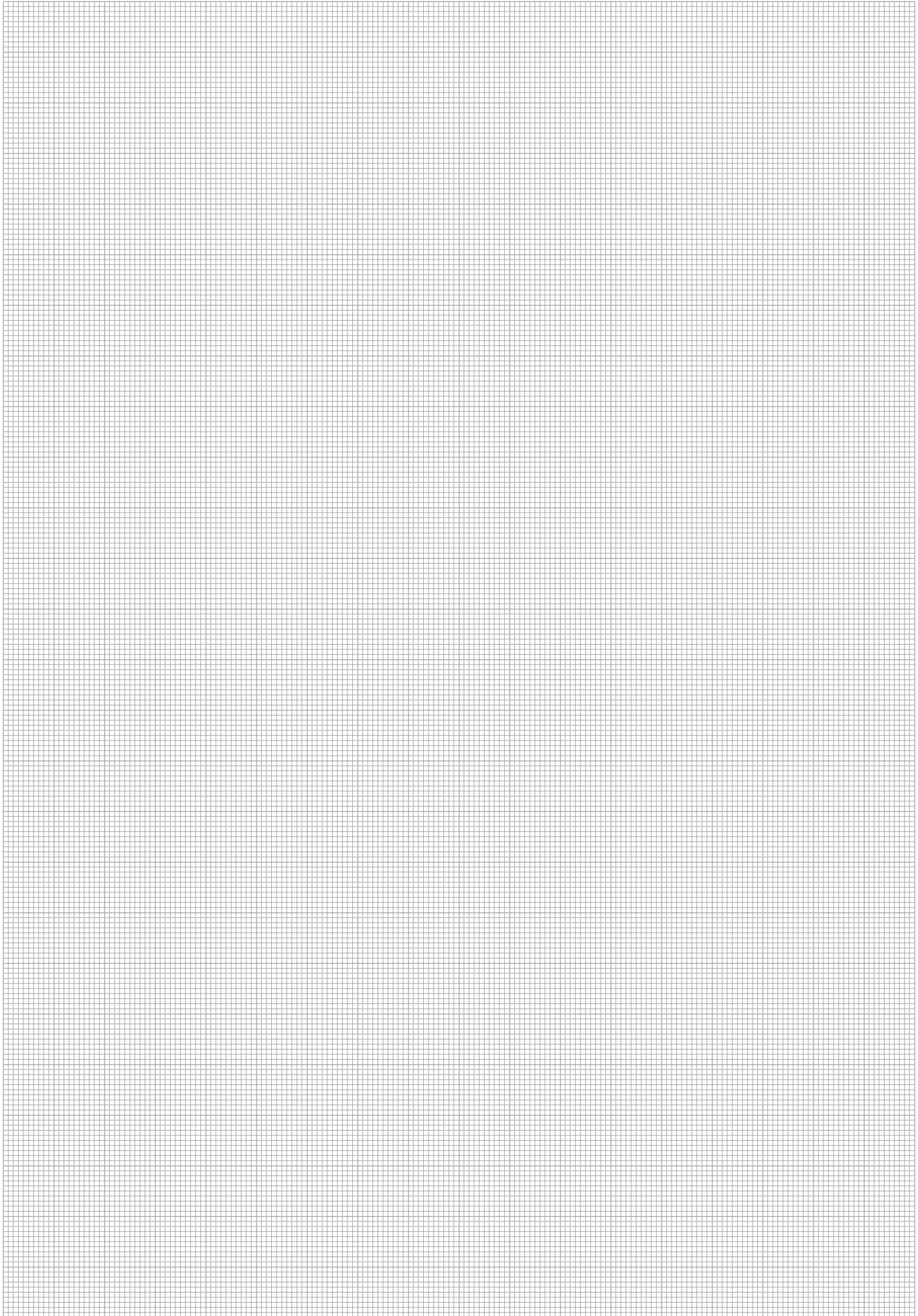









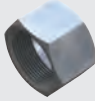

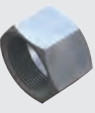















STAUFF Connect 37° Flared Tube Fittings can be used in applications with nominal pressures up to 500 bar on the Light Series or up to 630 bar in the Heavy Series (pressure reduction factors to be considered).





Overview of 24°- Tube Fittings (ISO 8434-1 / DIN 2353)

A

Connecting Parts	Double Edge Cutting Ring  Page 28 FI-DS	Soft-Sealing Cutting Ring  Page 29 FI-WDDS	Support Sleeve  Page 31 FI-VH	STAUFF Form EVO Sealing Ring  Page 32 FI-FD	Union Nut  Page 33 FI-M	24°/37° Flared Cone Adaptor with O-Rings  Page 34 FI-BA			
	Support Sleeve for 37° Flared Tube Fittings  Page 35 FI-BH	Union Nut for 37° Flared Tube Fittings  Page 36 FI-BM	37° Flared Tube Fitting Set  Page 37 FI-AB						
	Male Stud Fittings	Straight Male Stud Fitting  Page 40 FI-GE-	Male Stud Elbow  Page 74 FI-WE-	Male Stud Branch Tee  Page 82 FI-TE-	Male Stud Barrel Tee  Page 88 FI-LE-				
		Tube Fittings / Unions	Straight Union  Page 96 FI-G	Straight Reducer  Page 97 FI-G	Equal Elbow  Page 99 FI-W	Equal Tee  Page 100 FI-T	Tee Reducer  Page 101 FI-T	Equal Cross  Page 104 FI-K	
			Bulkhead Fittings	Straight Bulkhead Fitting  Page 108 FI-GS	Elbow Bulkhead Fittings  Page 109 FI-WS	Straight Bulkhead Weld Fitting  Page 110 FI-ES			
				Weld Fittings	Straight Weld Fitting  Page 114 FI-AS	Elbow Weld Fitting  Page 115 FI-WAS	24° Weld Cone with O-Ring  Page 116 FI-SN	24° Weld Cone Reducer with O-Ring  Page 118 FI-SNR	Straight Weld Fitting for Tubes  Page 120 FI-ASV
	Female Studs and Gauge Fittings				Straight Female Stud Fitting  Page 124 FI-GA-	Gauge Fitting  Page 129 FI-MA-	Gauge Fitting with 24° Taper / O-Ring  Page 130 FI-EMAD-	Gauge Standpipe Fitting  Page 131 FI-EMA-	
Fittings with 24° Taper / O-Ring (DKO)			Straight Male Stud Fitting  Page 134 FI-EGED		Straight Fitting / Reducer  Page 138 FI-SNV	Straight Reducer for Tube Ends  Page 144 FI-RESD	Distance Adaptor  Page 148 FI-RESD	Adjustable Elbow (90°)  Page 150 FI-EWD	Adjustable Elbow (45°)  Page 151 FI-EVD



Overview of 24°- Tube Fittings (ISO 8434-1 / DIN 2353)

A

Fittings with 24° Taper / O-Ring (DKO)

Adjustable Branch Tee

 Page 152
FI-ETD

Adjustable Barrel Tee

 Page 153
FI-ELD

Standpipe Fittings

Straight Male Stud Standpipe Fitting

 Page 156
FI-EGE

Straight Standpipe Reducer

 Page 162
FI-REDS

Adjustable Standpipe Elbow

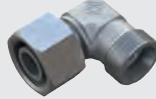
 Page 166
FI-EW

Adjustable Standpipe Branch Tee

 Page 167
FI-ET

Adjustable Standpipe Barrel Tee

 Page 168
FI-EL

Fittings with Lock Nut

Adjustable Male Stud Elbow (90°)

 Page 172
FI-WEE

Adjustable Male Stud Elbow (45°)

 Page 173
FI-VEE

Adjustable Male Stud Branch Tee

 Page 173
FI-TEE

Adjustable Male Stud Barrel Tee



 Page 173
FI-LEE

Banjo Fittings

Banjo Elbow (Medium-Pressure Version)

 Page 183
FI-RSWND

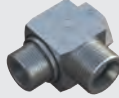
Banjo Elbow (High-Pressure Version)

 Page 186
FI-RSW

Banjo Tee (High-Pressure Version)

 Page 190
FI-RST

Swivel Fittings

Swivel Elbow

 Page 196
FI-DGWE

Hydraulic Valves

Check Valve

 Page 200-201
FI-RV / FI-RVA

Male Stud Check Valve (Flow from Stud End)

 Page 202-205
FI-RVV / FI-RVVA

Male Stud Check Valve (Flow to Stud End)

 Page 206-209
FI-RVZ / FI-RVZA

Female Stud Check Valve

 Page 210-211
FI-RVI / FI-RVIA

Check Valve Installation Kit

 Page 212
FI-VES

Alternating Valve

 Page 213
FI-WV

Spare Parts / Accessories

Thread Reducer

 Page 224
FI-RED

Blanking Screw for Ports (Heavy Duty)

 Page 228
FI-VSV

Blanking Screw for Ports

 Page 230
FI-VS

Blanking Plug with 24° Taper / O-Ring (DKO)

 Page 234
FI-VD

Blanking Plug with Sealing Edge

 Page 235
FI-BUZ

Blanking Plug for Tube Ends

 Page 236
FI-VSK

Hexagon Lock Nut

 Page 237
FI-SKM

Profile Sealing Ring

 Page 238
WDG

O-Ring

 Page 239
O-RING

External Metallic Sealing Ring

 Page 244
FI-DKR

Retaining Ring with Captive Seal

 Page 245
FI-DIR











Internal Metallic Sealing Ring

 Page 246
FI-DKI

Retaining Ring (Small)



 Page 247
FI-KR



	Double Edge Cutting Ring FI-DS	28
	Soft-Sealing Cutting Ring FI-WDDS	29
	Soft-Sealing Cutting Ring (Stainless Steel) FI-WDDS-W5	30
	Support Sleeve FI-VH	31
	STAUFF Form EVO Sealing Ring FI-FD	32
	Union Nut FI-M	33
	24°/37° Flared Cone Adaptor with O-Rings FI-BA	34
	Support Sleeve for 37° Flared Tube Fittings FI-BH	35
	Union Nut for 37° Flared Tube Fittings FI-BM	36
	37° Flared Tube Fitting Set FI-AB	37

Cutting Ring
Type FI-S (Single-Edge) ▪ Series LL
Type FI-DS (Double-Edge) ▪ Series L / S

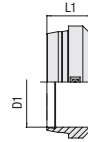
B



Ordering Codes

***FI-DS*-15*L*-W3**

* Cutting Ring Single-Edge Version **FI-S**
 Double-Edge Version **FI-DS**

* Outside Tube Diameter D1 (in mm) **-15**

* Series Extra-Light Series **LL**
 Light Series **L**
 Heavy Series **S**

* Material Code Steel, zinc/nickel-plated **-W3**

Please contact STAUFF for alternative materials and surface finishings.

Series	Tube OD	PN	Dimensions		Weight	Ordering Codes		
	mm		mm	mm		kg ca.	Double-Edge	Single-Edge
	D1	bar	L1		per 100	Cutting Ring	Cutting Ring	
LL	4	100	6		0,04		FI-S-04LL-W3	
	6	100	7		0,08		FI-S-06LL-W3	
	8	100	7		0,1		FI-S-08LL-W3	
	10	100	7		0,12		FI-S-10LL-W3	
	12	100	7,5		0,15		FI-S-12LL-W3	
L	6	500	9,5		0,21	FI-DS-06L/S-W3		
	8	500	9,5		0,26	FI-DS-08L/S-W3		
	10	500	10		0,34	FI-DS-10L/S-W3		
	12	400	10		0,44	FI-DS-12L/S-W3		
	15	400	10		0,54	FI-DS-15L-W3		
	18	400	10		0,71	FI-DS-18L-W3		
	22	250	11,5		1,01	FI-DS-22L-W3		
	28	250	11,5		1,23	FI-DS-28L-W3		
	35	250	13,5		2,35	FI-DS-35L-W3		
	42	250	13,5		2,69	FI-DS-42L-W3		
	S	6	800	9,5		0,21	FI-DS-06L/S-W3	
		8	800	9,5		0,26	FI-DS-08L/S-W3	
10		800	10		0,34	FI-DS-10L/S-W3		
12		630	10		0,44	FI-DS-12L/S-W3		
14		630	10,5		0,63	FI-DS-14S-W3		
16		630	10,5		0,69	FI-DS-16S-W3		
20		420	12,5		1,26	FI-DS-20S-W3		
25		420	12,5		1,52	FI-DS-25S-W3		
30		420	13,5		2,06	FI-DS-30S-W3		
38		420	13,5		2,54	FI-DS-38S-W3		

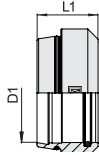

Soft-Sealing Cutting Ring
 Type FI-WDDS • Series L / S

B

Series	Tube OD mm	PN bar	Dimensions mm		Weight kgca. per 100	Ordering Codes Soft-Sealing Cutting Ring
			D1	L1		
L	6	500	8,8		0,19	FI-WDDS-06L/S-V-W3
	8	500	8,8		0,24	FI-WDDS-08L/S-V-W3
	10	500	9,8		0,35	FI-WDDS-10L/S-V-W3
	12	400	9,8		0,41	FI-WDDS-12L/S-V-W3
	15	400	10,2		0,66	FI-WDDS-15L-V-W3
	18	400	10,2		0,82	FI-WDDS-18L-V-W3
	22	250	11,5		1,06	FI-WDDS-22L-V-W3
	28	250	11,5		1,28	FI-WDDS-28L-V-W3
	35	250	13,5		2,36	FI-WDDS-35L-V-W3
	42	250	13,5		2,75	FI-WDDS-42L-V-W3
S	6	800	8,8		0,19	FI-WDDS-06L/S-V-W3
	8	800	8,8		0,24	FI-WDDS-08L/S-V-W3
	10	800	9,8		0,35	FI-WDDS-10L/S-V-W3
	12	630	9,8		0,41	FI-WDDS-12L/S-V-W3
	14	630	10,2		0,73	FI-WDDS-14S-V-W3
	16	630	10,3		0,83	FI-WDDS-16S-V-W3
	20	420	12,5		1,28	FI-WDDS-20S-V-W3
	25	420	12,5		1,58	FI-WDDS-25S-V-W3
	30	420	13,5		2,41	FI-WDDS-30S-V-W3
	38	420	13,5		3,00	FI-WDDS-38S-V-W3

Ordering Codes

***FI-WDDS*-15*L*-V*-W3**

* Soft-Sealing Cutting Ring		FI-WDDS
* Outside Tube Diameter D1 (in mm)		-15
* Series	Light Series	L
	Heavy Series	S
* Seal Material	FKM (Viton®)	-V
* Material Code	Steel, zinc/nickel-plated	-W3

Please contact STAUFF for alternative materials and surface finishings.

Standard seal material is FKM (Viton®).



Soft-Sealing Cutting Ring (Stainless Steel)
Type FI-WDDS-W5 ▪ Series L / S

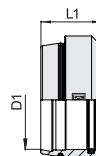

B

Ordering Codes

***FI-WDDS*-15*L*-V*-W5**

- * Soft-Sealing Cutting Ring (Stainless Steel) **FI-WDDS**
- * Outside Tube Diameter D1 (in mm) **-15**
- * Series **L**
 Light Series
 Heavy Series **S**
- * Seal Material **-V**
 FKM (Viton®)
- * Material Code **-W5**
 Stainless Steel V4A -
 1.4571 (AISI 316 Ti)

Please contact STAUFF for alternative materials and surface finishings.

Series	Tube OD	PN	Dimensions		Weight kg ca. per 100	Ordering Codes	
	mm D1		bar	mm L1			mm
L	6	500	8,8		0,2	FI-WDDS-06L/S-V-W5	
	8	500	8,8		0,25	FI-WDDS-08L/S-V-W5	
	10	500	9,8		0,37	FI-WDDS-10L/S-V-W5	
	12	400	9,8		0,44	FI-WDDS-12L/S-V-W5	
	15	400	10,2		0,68	FI-WDDS-15L-V-W5	
	18	400	10,0		0,80	FI-WDDS-18L-V-W5	
	22	250	11,5		1,09	FI-WDDS-22L-V-W5	
	28	250	11,5		1,39	FI-WDDS-28L-V-W5	
	35	250	13,5		2,47	FI-WDDS-35L-V-W5	
	42	250	13,5		2,89	FI-WDDS-42L-V-W5	
	S	6	800	8,8		0,2	FI-WDDS-06L/S-V-W5
		8	800	8,8		0,25	FI-WDDS-08L/S-V-W5
10		800	9,8		0,37	FI-WDDS-10L/S-V-W5	
12		630	9,8		0,44	FI-WDDS-12L/S-V-W5	
14		630	10,2		0,75	FI-WDDS-14S-V-W5	
16		630	10,3		0,86	FI-WDDS-16S-V-W5	
20		420	12,5		1,31	FI-WDDS-20S-V-W5	
25		420	12,5		1,64	FI-WDDS-25S-V-W5	
30		420	13,3		2,65	FI-WDDS-30S-V-W5	
38		420	13,5		3,20	FI-WDDS-38S-V-W5	

Standard seal material is FKM (Viton®).

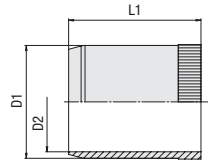

Support Sleeve
Type FI-VH

B

Dimensions mm				Ordering Codes
for Tube	D1	D2	L1	
6 x 1	4	2,6	15,5	FI-VH-6x1-W69
6 x 0,75	4,5	3,1	12,5	FI-VH-6x0.75-W69
6 x 0,5	5	3,6	12,5	FI-VH-6x0.5-W69
8 x 1	6	4,6	15,5	FI-VH-8x1-W69
8 x 0,75	6,5	5,1	12,5	FI-VH-8x0.75-W69
10 x 1,5	7	5,6	17	FI-VH-10x1.5-W69
10 x 1	8	6,6	16,5	FI-VH-10x1-W69
10 x 0,75	8,5	7,1	16,5	FI-VH-10x0.75-W69
12 x 1,5	9	7,6	16,5	FI-VH-12x1.5-W69
12 x 1	10	8,6	16,5	FI-VH-12x1-W69
12 x 0,75	10,5	9,3	16,5	FI-VH-12x0.75-W69
14 x 1	12	10,2	18	FI-VH-14x1-W69
15 x 1,5	12	10,2	17	FI-VH-15x1.5-W69
15 x 1	13	11,2	17	FI-VH-15x1-W69
18 x 1,5	15	13,2	17,5	FI-VH-18x1.5-W69
18 x 1	16	14,2	17,5	FI-VH-18x1-W69
20 x 1	18	16,2	22	FI-VH-20x1-W69
22 x 1,5	19	17,2	18	FI-VH-22x1.5-W69
22 x 1	20	18,2	18	FI-VH-22x1-W69
25 x 1,5	22	20,2	23,5	FI-VH-25x1.5-W69
25 x 1	23	21,2	23,5	FI-VH-25x1-W69
28 x 2	24	22,2	23,5	FI-VH-28x2-W69
28 x 1,5	25	23,2	23,5	FI-VH-28x1.5-W69
28 x 1	26	24,2	23,5	FI-VH-28x1-W69
35 x 2	31	28,8	23,5	FI-VH-35x2-W69
35 x 1,5	32	29,8	23,5	FI-VH-35x1.5-W69
35 x 1	33	30,8	23,5	FI-VH-35x1-W69
42 x 2	38	35,8	23,5	FI-VH-42x2-W69
42 x 1,5	39	36,8	23,5	FI-VH-42x1.5-W69

Ordering Codes

***FI-VH*-10*x1.5*-W69**

* Support Sleeve	FI-VH
* Outside Tube Diameter (in mm)	-10
* Wall Thickness (in mm)	x1.5
* Material Code	Brass -W69

Please contact STAUFF for alternative materials and surface finishings.



STAUFF Form EVO Sealing Ring
Type FI-FD • Series L / S

B

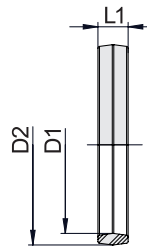

Ordering Codes

***FI-FD*-15*L*-V90**

* STAUFF Form EVO Sealing Ring

* Outside Tube Diameter D1 (in mm)

* Series Light Series
 Heavy Series

* Seal Material FKM (Viton®) 90 Shore

FI-FD

-15

L

S

-V90

Please contact STAUFF for alternative materials and surface finishings.

Series	Tube OD	PN	Dimensions		Weight	Ordering Codes
	mm		mm	mm		
	D1	bar	D2	L1	kg ca.	
					per 100	
L	6	500	7,8	2,6	0,01	FI-FD-06L/S-V90
	8	500	9,8	2,6	0,01	FI-FD-08L/S-V90
	10	500	12	2,8	0,02	FI-FD-10L/S-V90
	12	400	14	2,8	0,02	FI-FD-12L/S-V90
	15	400	17	2,8	0,03	FI-FD-15L-V90
	18	400	20	2,8	0,03	FI-FD-18L-V90
	22	250	24	2,8	0,04	FI-FD-22L-V90
	28	250	30	2,8	0,05	FI-FD-28L-V90
	35	250	37,8	3,4	0,10	FI-FD-35L-V90
	42	250	44,8	3,4	0,12	FI-FD-42L-V90
S	6	800	7,8	2,6	0,01	FI-FD-06L/S-V90
	8	800	9,8	2,6	0,01	FI-FD-08L/S-V90
	10	800	12	2,8	0,02	FI-FD-10L/S-V90
	12	630	14	2,8	0,02	FI-FD-12L/S-V90
	16	630	18	2,8	0,03	FI-FD-16S-V90
	20	400	22,6	3,4	0,05	FI-FD-20S-V90
	25	400	27,6	3,4	0,07	FI-FD-25S-V90
	30	400	32,8	3,4	0,09	FI-FD-30S-V90
	38	400	40,8	3,4	0,11	FI-FD-38S-V90

Standard seal material is FKM (Viton®).

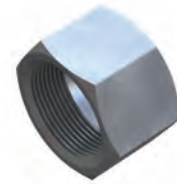
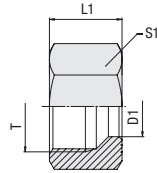

Union Nut
 Type FI-M • Series LL / L / S

B

Series	Tube OD mm	PN bar	Dimensions mm			Weight kg ca. per 100	Ordering Codes
			Thread T	L1	S1		
LL	4	100	M 8 x 1	11	10	0,40	FI-M-04LL-W3
	6	100	M 10 x 1	11,5	12	0,50	FI-M-06LL-W3
	8	100	M 12 x 1	12	14	0,70	FI-M-08LL-W3
	10	100	M 14 x 1	12,5	17	1,10	FI-M-10LL-W3
	12	100	M 16 x 1	13	19	1,30	FI-M-12LL-W3
L	6	500	M 12 x 1,5	14,5	14	0,90	FI-M-06L-W3
	8	500	M 14 x 1,5	14,5	17	1,40	FI-M-08L-W3
	10	500	M 16 x 1,5	15,5	19	1,70	FI-M-10L-W3
	12	400	M 18 x 1,5	15,5	22	2,40	FI-M-12L-W3
	15	400	M 22 x 1,5	17	27	4,10	FI-M-15L-W3
	18	400	M 26 x 1,5	18	32	6,00	FI-M-18L-W3
	22	250	M 30 x 2	20	36	8,00	FI-M-22L-W3
	28	250	M 36 x 2	22	41	14,20	FI-M-28L-W3
	35	250	M 45 x 2	25	50	19,80	FI-M-35L-W3
	42	250	M 52 x 2	25	60	22,00	FI-M-42L-W3
	S	6	800	M 14 x 1,5	16,5	17	1,70
8		800	M 16 x 1,5	16,5	19	2,00	FI-M-08S-W3
10		800	M 18 x 1,5	17,5	22	3,00	FI-M-10S-W3
12		630	M 20 x 1,5	17,5	24	3,40	FI-M-12S-W3
14		630	M 22 x 1,5	20,5	27	5,20	FI-M-14S-W3
16		630	M 24 x 1,5	20,5	30	6,50	FI-M-16S-W3
20		420	M 30 x 2	24	36	10,10	FI-M-20S-W3
25		420	M 36 x 2	27	46	19,80	FI-M-25S-W3
30		420	M 42 x 2	29	50	21,60	FI-M-30S-W3
38		420	M 52 x 2	32,5	60	31,40	FI-M-38S-W3

Ordering Codes

***FI-M*-15*L*-W3**

* Union Nut		FI-M
* Outside Tube Diameter D1 (in mm)		-15
* Series	Extra-Light Series	LL
	Light Series	L
	Heavy Series	S
* Material Code	Steel, zinc/nickel-plated	-W3

Please contact STAUFF for alternative materials and surface finishings.



24°/37° Flared Cone Adaptor with O-Rings
Type FI-BA ▪ Series L / S

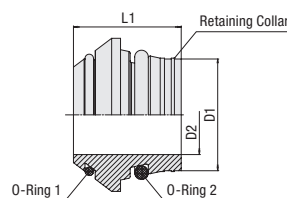

B

Ordering Codes

***FI-BA*-10*L*-V*-W3**

* 24°/37° Flared Cone Adaptor with O-Rings **FI-BA**

* Outside Tube Diameter D1 (in mm) **-10**

* Series Light Series **L**
 Heavy Series **S**

* Seal Material FKM (Viton®) **-V**

* Material Code Steel, zinc/nickel-plated **-W3**

Please contact STAUFF for alternative materials and surface finishings.

Spare Parts / Accessories



O-Ring
 Type **O-RING**

Page 240

Series	Tube OD PN		Dimensions				Weight kg ca. per 100	Ordering Codes
	mm D1	bar	mm D2	L1	O-Ring 1	O-Ring 2		
L	6	500	3	11,5	4,4 x 0,8	4,5 x 1,5	0,28	FI-BA-06L/S-V-W3
	8	500	5	12	6,0 x 0,8	6,5 x 1,5	0,40	FI-BA-08L/S-V-W3
	10	500	6	12,5	7,5 x 0,8	8,5 x 1,5	0,65	FI-BA-10L/S-V-W3
	12	400	8	12,5	9,5 x 0,8	10,0 x 1,5	0,80	FI-BA-12L/S-V-W3
	15	400	11	12,5	12,5 x 0,8	12,5 x 2,0	1,05	FI-BA-15L-V-W3
	18	400	14	13	15,0 x 1,0	16,0 x 2,0	1,26	FI-BA-18L-V-W3
	22	250	17	14,2	18,0 x 1,0	20,0 x 2,0	2,01	FI-BA-22L-V-W3
	28	250	23	14,7	23,0 x 1,0	26,0 x 2,0	2,82	FI-BA-28L-V-W3
	35	250	28	18,5	30,0 x 1,0	32,0 x 2,5	5,86	FI-BA-35L-V-W3
	42	250	35	20,5	37,0 x 1,0	38,0 x 2,5	4,40	FI-BA-42L-V-W3
	S	6	630	3	11,5	4,4 x 0,8	4,5 x 1,5	0,28
8		630	5	12	6,0 x 0,8	6,5 x 1,5	0,40	FI-BA-08L/S-V-W3
10		630	6	12,5	7,5 x 0,8	8,5 x 1,5	0,65	FI-BA-10L/S-V-W3
12		630	8	12,5	9,5 x 0,8	10,0 x 1,5	0,80	FI-BA-12L/S-V-W3
14		630	9	14	11,0 x 1,0	12,0 x 2,0	1,20	FI-BA-14S-V-W3
16		630	11	15	12,5 x 1,0	14,0 x 2,0	1,50	FI-BA-16S-V-W3
20		400	14	18,5	16,0 x 1,0	17,3 x 2,4	2,73	FI-BA-20S-V-W3
25		400	19	20	20,0 x 1,0	22,3 x 2,4	3,78	FI-BA-25S-V-W3
30		400	23	22	25,0 x 1,0	27,3 x 2,4	3,82	FI-BA-30S-V-W3
38		400	30	26	31,47 x 1,78	35,0 x 2,5	9,15	FI-BA-38S-V-W3

Standard seal material is FKM (Viton®).



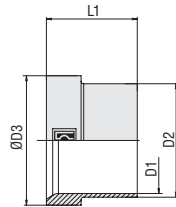

Support Sleeve for 37° Flared Tube Fittings Type FI-BH ■ Series L / S



B

Series	Tube OD		Dimensions			Weight kg ca. per 100	Ordering Codes
	mm	bar	mm	D3	L1		
	D1		D2				
L	6	500	7,6	10,2	10	0,21	FI-BH-06L/S-W3
	8	500	9,3	12,2	11	0,25	FI-BH-08L/S-W3
	10	500	11,5	14,2	12	0,37	FI-BH-10L/S-W3
	12	400	13,6	16,2	12,5	0,46	FI-BH-12L/S-W3
	15	400	17,5	20,2	13,5	0,89	FI-BH-15L-W3
	18	400	21	24,2	14	1,40	FI-BH-18L-W3
	22	250	24,2	27,8	17,5	1,59	FI-BH-22L-W3
	28	250	30,2	33,8	16,5	1,99	FI-BH-28L-W3
	35	250	38	42,7	18,5	3,70	FI-BH-35L-W3
	42	250	45	49,7	20,5	4,94	FI-BH-42L-W3
S	6	630	7,6	10,2	10	0,21	FI-BH-06L/S-W3
	8	630	9,3	12,2	11	0,25	FI-BH-08L/S-W3
	10	630	11,5	14,2	12	0,37	FI-BH-10L/S-W3
	12	630	13,6	16,2	12,5	0,46	FI-BH-12L/S-W3
	14	630	17,5	20,2	14	1,20	FI-BH-14S-W3
	16	630	18,5	22	16,5	1,25	FI-BH-16S-W3
	20	400	24,2	27,8	17	2,39	FI-BH-20S-W3
	25	400	28,5	32,8	19,5	2,98	FI-BH-25S-W3
	30	400	34	39	21	4,50	FI-BH-30S-W3
	38	400	42	48,5	26	7,34	FI-BH-38S-W3

Ordering Codes

FI-BH-15*L*-W3

* Support Sleeve for 37° Flared Tube Fittings	FI-BH
* Outside Tube Diameter D1 (in mm)	-15
* Series	Light Series L Heavy Series S
* Material Code	Steel, zinc/nickel-plated -W3

Please contact STAUFF for alternative materials and surface finishings.



Union Nut for 37° Flared Tube Fittings
Type FI-BM ▪ Series L / S

B

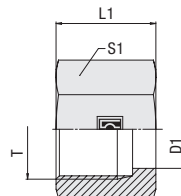
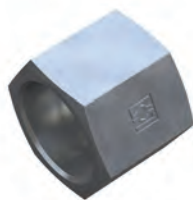

Ordering Codes

***FI-BM*-15*L*-W3**

* Union Nut for 37° Flared Tube Fittings

* Outside Tube Diameter D1 (in mm)

* Series Light Series
 Heavy Series

* Material Code Steel, zinc/nickel-plated

Please contact STAUFF for alternative materials and surface finishings.

FI-BM

-15

L

S

-W3

Series	Tube OD mm	PN bar	Dimensions mm				Weight kg ca. per 100	Ordering Codes
			Thread T	D1	L1	S1		
L	6	500	M 12 x 1,5	7,8	17	14	1,07	FI-BM-06L-W3
	8	500	M 14 x 1,5	9,5	18	17	1,82	FI-BM-08L-W3
	10	500	M 16 x 1,5	11,7	19,5	19	2,35	FI-BM-10L-W3
	12	400	M 18 x 1,5	13,8	20,5	22	3,36	FI-BM-12L-W3
	15	400	M 22 x 1,5	17,7	23	27	5,31	FI-BM-15L-W3
	18	400	M 26 x 1,5	21,2	23	32	7,22	FI-BM-18L-W3
	22	250	M 30 x 2	24,4	27,5	36	10,60	FI-BM-22L-W3
	28	250	M 36 x 2	30,4	27,5	41	11,47	FI-BM-28L-W3
	35	250	M 45 x 2	38,3	30	50	16,27	FI-BM-35L-W3
	42	250	M 52 x 2	45,3	34	60	30,39	FI-BM-42L-W3
	S	6	630	M 14 x 1,5	7,8	18	17	2,03
8		630	M 16 x 1,5	9,5	19	19	2,52	FI-BM-08S-W3
10		630	M 18 x 1,5	11,7	20,5	22	3,58	FI-BM-10S-W3
12		630	M 20 x 1,5	13,8	21	24	4,11	FI-BM-12S-W3
14		630	M 22 x 1,5	17,7	23	27	5,38	FI-BM-14S-W3
16		630	M 24 x 1,5	18,7	26,5	30	7,87	FI-BM-16S-W3
20		400	M 30 x 2	24,4	27,5	36	10,61	FI-BM-20S-W3
25		400	M 36 x 2	28,7	30,5	46	22,19	FI-BM-25S-W3
30		400	M 42 x 2	34,2	32	50	23,20	FI-BM-30S-W3
38		400	M 52 x 2	42,3	38	60	35,40	FI-BM-38S-W3



37° Flared Tube Fitting Set Type FI-AB ■ Series L / S

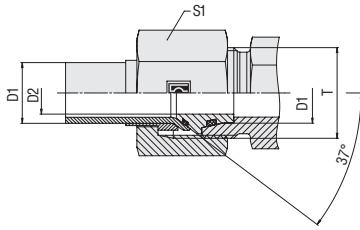

B

Series	Tube OD		Dimensions mm	Weight kg ca. per 100	Ordering Codes			
	mm	bar			Thread	T	S1	
L	6	500	M 12 x 1,5	3	14	1,74	FI-AB-06L-V-W3	
	8	500	M 14 x 1,5	5	17	2,50	FI-AB-08L-V-W3	
	10	500	M 16 x 1,5	6	19	3,38	FI-AB-10L-V-W3	
	12	400	M 18 x 1,5	8	22	4,83	FI-AB-12L-V-W3	
	15	400	M 22 x 1,5	11	27	4,66	FI-AB-15L-V-W3	
	18	400	M 26 x 1,5	14	32	10,11	FI-AB-18L-V-W3	
	22	250	M 30 x 2	17	36	14,25	FI-AB-22L-V-W3	
	28	250	M 36 x 2	23	41	16,47	FI-AB-28L-V-W3	
	35	250	M 45 x 2	28	50	25,86	FI-AB-35L-V-W3	
	42	250	M 52 x 2	35	60	42,85	FI-AB-42L-V-W3	
	S	6	630	M 14 x 1,5	3	17	2,51	FI-AB-06S-V-W3
		8	630	M 16 x 1,5	5	19	3,39	FI-AB-08S-V-W3
10		630	M 18 x 1,5	6	22	4,77	FI-AB-10S-V-W3	
12		630	M 20 x 1,5	8	24	5,63	FI-AB-12S-V-W3	
14		630	M 22 x 1,5	9	27	7,77	FI-AB-14S-V-W3	
16		630	M 24 x 1,5	11	30	10,88	FI-AB-16S-V-W3	
20		400	M 30 x 2	14	36	15,90	FI-AB-20S-V-W3	
25		400	M 36 x 2	19	46	29,34	FI-AB-25S-V-W3	
30		400	M 42 x 2	23	50	33,64	FI-AB-30S-V-W3	
38		400	M 52 x 2	30	60	52,40	FI-AB-38S-V-W3	

Ordering Codes

***FI-AB*-15*L*-V*-W3**

* 37° Flared Tube Fitting Set

FI-AB

* Outside Tube Diameter D1 (in mm)

-15

* Series

Light Series

L

Heavy Series

S

* Seal Material

FKM (Viton®)

-V

* Material Code

Steel, zinc/nickel-plated

-W3

Please contact STAUFF for alternative materials and surface finishings.

Spare Parts / Accessories



O-Ring

Type **O-RING**

Page 240

Standard seal material is FKM (Viton®).





Straight Male Stud Fitting 40-73

FI-GE



**Whitworth Parallel Pipe Thread (BSPP) /
Metallic Sealing Edge 40**
FI-GE-...-R



**Metric Parallel Thread /
Metallic Sealing Edge 44**
FI-GE-...-M



**Whitworth Parallel Pipe Thread (BSPP) /
Profile Sealing Ring 48**
FI-GE-...-R-WD



**Metric Parallel Thread /
Profile Sealing Ring 52**
FI-GE-...-M-WD



**BSPP Thread / 60° Conical Bore /
Sealing Surface for Gaskets 55**
FI-GE-...-R-DF



**Metric Parallel Thread /
O-Ring 57**
FI-GE-...-M-OR



Whitworth Taper Pipe Thread (BSPT) 60
FI-GE-...-Rk



Metric Taper Thread 64
FI-GE-...-Mk



NPT Thread 65
FI-GE-...-N



**UN/UNF Thread /
O-Ring 70**
FI-GE-...-U

Male Stud Elbow 74-81
 FI-WE

**Whitworth Parallel Pipe Thread (BSPP) /
 Metallic Sealing Edge** 74
 FI-WE-...-R

**Metric Parallel Thread /
 Metallic Sealing Edge** 75
 FI-WE-...-M

Whitworth Taper Pipe Thread (BSPT) 76
 FI-WE-...-Rk

Metric Taper Thread 78
 FI-WE-...-Mk

NPT Thread 80
 FI-WE-...-N

Male Stud Branch Tee 82-87
 FI-TE

**Whitworth Parallel Pipe Thread (BSPP) /
 Metallic Sealing Edge** 82
 FI-TE-...-R

**Metric Parallel Thread /
 Metallic Sealing Edge** 83
 FI-TE-...-M

Whitworth Taper Pipe Thread (BSPT) 84
 FI-TE-...-Rk

Metric Taper Thread 85
 FI-TE-...-Mk

NPT Thread 86
 FI-TE-...-N

Male Stud Barrel Tee 88-93
 FI-LE

**Whitworth Parallel Pipe Thread (BSPP) /
 Metallic Sealing Edge** 88
 FI-LE-...-R

**Metric Parallel Thread /
 Metallic Sealing Edge** 89
 FI-LE-...-M

Whitworth Taper Pipe Thread (BSPT) 90
 FI-LE-...-Rk

Metric Taper Thread 91
 FI-LE-...-Mk

NPT Thread 92
 FI-LE-...-N

Straight Male Stud Fitting
Type FI-GE-...-R • Series LL / L

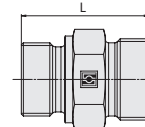
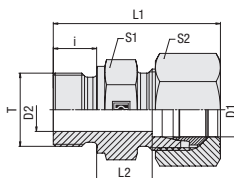

C

Whitworth Parallel Pipe Thread (BSPP)

Metallic Sealing Edge

Ordering Codes

***FI-GE*-10*L*R*-W3*-MS**

- * Straight Male Stud Fitting **FI-GE**
- * Outside Tube Diameter D1 (in mm) **-10**
- * Series **LL**
 Extra-Light Series (page 40)
 Light Series (pages 40/41)
 Heavy Series (pages 42/43) **L**
S
- * Thread Type **R**
 Whitworth Parallel
 Pipe Thread (BSPP)
- If required, please indicate special sizes, e.g. R1/8!
- * Material Code **-W3**
 Steel, zinc/nickel-plated
- Please contact STAUFF for alternative materials and surface finishings.
- * Assembling / Kitting **-**
 Fitting body only
 Fitting body supplied with cutting ring and union nut **-MS**
 Fitting body supplied with soft-sealing cutting ring and union nut **-MSV**

Series	Tube OD mm D1	PN bar	Dimensions mm								Torque N-m Thread T	Weight kg ca. per 100	Ordering Codes ³
			Thread T	D2	i	L	L1 ¹	L2	S1	S2			
LL	4	100	G 1/8	3	8	21,5	25,5	9,5	14	10	25	1,17	FI-GE-04LLR-W3
	6	100	G 1/8	4	8	21,5	25,5	8	14	12	25	1,16	FI-GE-06LLR-W3
	8	100	G 1/8	4	8	22,5	26,5	9	14	14	25	1,33	FI-GE-08LLR-W3
	10	100	G 1/4	6	12	28	35	10,5	19	17	55	2,66	FI-GE-10LLR-W3
L	6	400	G 1/8	4	8	23,5	31,5	8,5	14	14	25	1,37	FI-GE-06LR-W3
	6	400	G 1/4	4	12	29	37	10	19	14	55	2,84	FI-GE-06LR1/4-W3
	6	400	G 3/8	4	12	30,5	38,5	11,5	22	14	95	4,13	FI-GE-06LR3/8-W3
	6	400	G 1/2	4	14	33	41	12	27	14	185	6,48	FI-GE-06LR1/2-W3
	8	400	G 1/8	4	8	24,5	32,5	9,5	14	17	25	1,61	FI-GE-08LR1/8-W3
	8	400	G 1/4	6	12	29	37	10	19	17	55	2,72	FI-GE-08LR-W3
	8	400	G 3/8	6	12	30,5	38,5	11	22	17	95	4,46	FI-GE-08LR3/8-W3
	8	400	G 1/2	6	14	33	41	12	27	17	185	7,51	FI-GE-08LR1/2-W3
	10	400	G 1/8	4	8	25,5	33,5	10,5	17	19	25	2,00	FI-GE-10LR1/8-W3
	10	400	G 1/4	6	12	30	38	11	19	19	55	2,95	FI-GE-10LR-W3
	10	400	G 3/8	8	12	31,5	39,5	12,5	22	19	95	4,29	FI-GE-10LR3/8-W3
	10	400	G 1/2	8	14	34	42	13	27	19	185	7,08	FI-GE-10LR1/2-W3
	10	400	G 3/4	8	16	37,5	45,5	14,5	32	19	250	9,29	FI-GE-10LR3/4-W3
	12	400	G 1/8	4	8	26,5	34,5	11,5	19	22	25	2,49	FI-GE-12LR1/8-W3
	12	400	G 1/4	6	12	31	39	12	19	22	55	3,10	FI-GE-12LR1/4-W3
	12	400	G 3/8	9	12	31,5	39,5	12,5	22	22	95	4,24	FI-GE-12LR-W3
	12	400	G 1/2	10	14	34	42	13	27	22	185	6,67	FI-GE-12LR1/2-W3
	12	400	G 3/4	10	16	37	45	14	32	22	250	10,83	FI-GE-12LR3/4-W3

¹ Approximate dimension in assembled condition.

² Weight excluding cutting ring and union nut.

³ Standard scope of delivery: Fitting body only.

Male stud acc. to DIN 3852-2 (Form B) / ISO 1179-4 (Type B)
 Port acc. to DIN 3852-2 (Form X) / ISO 1179-1

Torque recommendations for Steel mating material.

Connecting Parts

-  Cutting Ring
Type **FI-DS** Page 28
-  Soft-Sealing Cutting Ring
Type **FI-WDDS** Page 29
-  Support Sleeve
Type **FI-VH** Page 31
-  STAUFF Form EVO Sealing Ring
Type **FI-FD** Page 32
-  Union Nut
Type **FI-M** Page 33
-  37° Flared Tube Fitting Set
Type **FI-AB** Page 37

Male threaded studs were designed for female threaded ports in components made of steel. For applications with components made of softer mating materials (e.g. Aluminium), the use of connectors with additionally rolled male threads is recommended.
 Please contact STAUFF prior to the assembly for further information.



Straight Male Stud Fitting
Type FI-GE-...-R • Series L

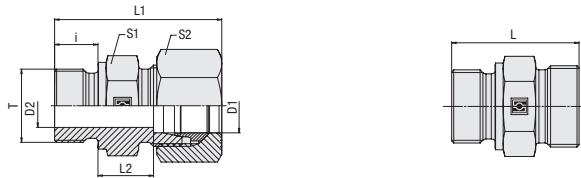

C

Metallic Sealing Edge

Whitworth Parallel Pipe Thread (BSPP)

Series	Tube OD mm	PN bar	Dimensions mm										Torque N-m	Weight kg ca. per 100	Ordering Codes ³
			Thread T	D2	i	L	L ¹	L2	S1	S2	Thread T				
L	15	400	G 1/4	6	12	33	41	14	24	27	55	4,93	FI-GE-15LR1/4-W3		
	15	400	G 3/8	9	12	32,5	40,5	13	24	27	95	5,03	FI-GE-15LR3/8-W3		
	15	400	G 1/2	11	14	35	43	14	27	27	185	6,53	FI-GE-15LR-W3		
	15	400	G 3/4	12	16	38	46	15	32	27	250	10,06	FI-GE-15LR3/4-W3		
	18	200	G 3/8	9	12	33,5	42,5	14	27	32	95	6,41	FI-GE-18LR3/8-W3		
	18	200	G 1/2	14	14	36	45	14,5	27	32	185	7,13	FI-GE-18LR-W3		
	18	200	G 3/4	15	16	38	47	14,5	32	32	250	11,28	FI-GE-18LR3/4-W3		
	18	200	G 1	15	18	40	49	14,5	41	32	400	15,87	FI-GE-18LR1-W3		
	22	200	G 1/2	14	14	38	47	16,5	32	36	185	8,57	FI-GE-22LR1/2-W3		
	22	200	G 3/4	18	16	40	49	16,5	32	36	250	10,48	FI-GE-22LR-W3		
	22	200	G 1	19	18	43	52	17,5	41	36	400	19,17	FI-GE-22LR1-W3		
	28	200	G 1/2	14	14	39	48	17,5	41	41	185	6,11	FI-GE-28LR1/2-W3		
	28	200	G 3/4	18	16	41	50	17,5	41	41	250	14,42	FI-GE-28LR3/4-W3		
	28	200	G 1	23	18	43	52	17,5	41	41	400	17,08	FI-GE-28LR-W3		
	28	200	G 1 1/4	24	20	46	55	18,5	50	41	670	13,40	FI-GE-28LR1-1/4-W3		
	28	200	G 1 1/2	36	22	50	65	20,5	55	41	800	33,31	FI-GE-28LR1-1/2-W3		
	35	200	G 1	23	18	46	57	17,5	46	50	400	22,45	FI-GE-35LR1-W3		
	35	200	G 1 1/4	30	20	48	59	17,5	50	50	670	27,69	FI-GE-35LR-W3		
	35	200	G 1 1/2	30	22	52	63	19,5	55	50	800	42,63	FI-GE-35LR1-1/2-W3		
	42	200	G 1	23	18	48	60	19	55	60	400	32,20	FI-GE-42LR1-W3		
	42	200	G 1 1/4	30	20	50	62	19	55	60	670	34,71	FI-GE-42LR1-1/4-W3		
	42	200	G 1 1/2	36	22	52	64	19	55	60	800	34,78	FI-GE-42LR-W3		

¹ Approx.imate dimension in assembled condition.

² Weight excluding cutting ring and union nut.

³ Standard scope of delivery: Fitting body only.

Male stud acc. to DIN 3852-2 (Form B) / ISO 1179-4 (Type B)
Port acc. to DIN 3852-2 (Form X) / ISO 1179-1

Torque recommendations for Steel mating material.

Male threaded studs were designed for female threaded ports in components made of steel. For applications with components made of softer mating materials (e.g. Aluminium), the use of connectors with additionally rolled male threads is recommended. Please contact STAUFF prior to the assembly for further information.

Ordering Codes

FI-GE-10*L*R*-W3*-MS

* Straight Male Stud Fitting	FI-GE
* Outside Tube Diameter D1 (in mm)	-10
* Series	Extra-Light Series (page 40) LL Light Series (pages 40/41) L Heavy Series (pages 42/43) S
* Thread Type	Whitworth Parallel Pipe Thread (BSPP) R
If required, please indicate special sizes, e.g. R1/8!	
* Material Code	Steel, zinc/nickel-plated -W3
Please contact STAUFF for alternative materials and surface finishings.	
* Assembling / Kitting	Fitting body only —
	Fitting body supplied with cutting ring and union nut -MS
	Fitting body supplied with soft-sealing cutting ring and union nut -MSV

Connecting Parts

	Cutting Ring Type FI-DS	Page 28
	Soft-Sealing Cutting Ring Type FI-WDDS	Page 29
	Support Sleeve Type FI-VH	Page 31
	STAUFF Form EVO Sealing Ring Type FI-FD	Page 32
	Union Nut Type FI-M	Page 33
	37° Flared Tube Fitting Set Type FI-AB	Page 37



Straight Male Stud Fitting
Type FI-GE-...-R • Series S

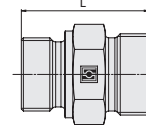
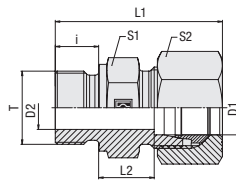

C

Whitworth Parallel Pipe Thread (BSPP)

Metallic Sealing Edge

Ordering Codes

***FI-GE*-10*S*R*-W3*-MS**

- * Straight Male Stud Fitting **FI-GE**
- * Outside Tube Diameter D1 (in mm) **-10**
- * Series **LL**
 Extra-Light Series (page 40)
 Light Series (pages 40/41)
L
 Heavy Series (pages 42/43)
S
- * Thread Type **R**
 Whitworth Parallel
 Pipe Thread (BSPP)
- If required, please indicate special sizes, e.g. R1/8!
- * Material Code **-W3**
 Steel, zinc/nickel-plated
- Please contact STAUFF for alternative materials and surface finishings.
- * Assembling / Kitting **-**
 Fitting body only
 Fitting body supplied with cutting ring and union nut **-MS**
 Fitting body supplied with soft-sealing cutting ring and union nut **-MSV**

Series	Tube OD mm D1	PN bar	Dimensions mm										Torque N-m Thread T	Weight kg ca. per 100	Ordering Codes ³
			Thread T	D2	i	L	L1 ¹	L2	S1	S2					
S	6	500	G 1/8	4	8	28	36	13	17	17	30	2,55	FI-GE-06SR1/8-W3		
	6	630	G 1/4	4	12	32	40	13	19	17	80	3,49	FI-GE-06SR-W3		
	6	630	G 3/8	4	12	34,5	42,5	15,5	22	17	130	2,29	FI-GE-06SR3/8-W3		
	6	630	G 1/2	4	14	39	47	18	27	17	220	9,40	FI-GE-06SR1/2-W3		
	8	630	G 1/4	5	12	34	42	15	19	19	80	4,06	FI-GE-08SR-W3		
	8	630	G 3/8	5	12	34,5	42,5	15,5	22	19	130	5,77	FI-GE-08SR3/8-W3		
	8	630	G 1/2	5	14	39	47	18	27	19	220	9,91	FI-GE-08SR1/2-W3		
	10	630	G 1/4	5	12	34	43	14,5	19	22	80	4,35	FI-GE-10SR1/4-W3		
	10	630	G 3/8	7	12	34,5	43,5	15	22	22	130	5,68	FI-GE-10SR-W3		
	10	630	G 1/2	7	14	39	48	17,5	27	22	220	9,73	FI-GE-10SR1/2-W3		
	12	630	G 1/4	5	12	36	45	16,5	22	24	80	5,93	FI-GE-12SR1/4-W3		
	12	630	G 3/8	8	12	36,5	45,5	17	22	24	130	5,02	FI-GE-12SR-W3		
	12	630	G 1/2	8	14	39	48	17,5	27	24	220	9,72	FI-GE-12SR1/2-W3		
	12	630	G 3/4	8	16	43	52	19,5	32	24	350	16,48	FI-GE-12SR3/4-W3		
	14	400	G 1/4	5	12	36	46	16	22	27	80	6,72	FI-GE-14SR1/4-W3		
	14	400	G 3/8	8	12	38,5	48,5	18,5	22	27	130	6,95	FI-GE-14SR3/8-W3		
	14	400	G 1/2	10	14	41	51	19	27	27	220	9,79	FI-GE-14SR-W3		
	14	400	G 3/4	10	16	45	55	21	32	27	350	16,30	FI-GE-14SR3/4-W3		
	16	400	G 3/8	8	12	38,5	48,5	18	27	30	130	6,42	FI-GE-16SR3/8-W3		
	16	400	G 1/2	12	14	41	51	18,5	27	30	220	9,15	FI-GE-16SR-W3		
16	400	G 3/4	12	16	45	55	20,5	32	30	350	15,75	FI-GE-16SR3/4-W3			
16	400	G 1	20	18	49	60	22,5	41	30	700	24,6	FI-GE-16SR1-W3			

¹ Approximate dimension in assembled condition.

² Weight excluding cutting ring and union nut.

³ Standard scope of delivery: Fitting body only.

Male stud acc. to DIN 3852-2 (Form B) / ISO 1179-4 (Type B)
 Port acc. to DIN 3852-2 (Form X) / ISO 1179-1

Torque recommendations for Steel mating material.

Connecting Parts

-  Cutting Ring
Type **FI-DS** Page 28
-  Soft-Sealing Cutting Ring
Type **FI-WDDS** Page 29
-  Support Sleeve
Type **FI-VH** Page 31
-  STAUFF Form EVO Sealing Ring
Type **FI-FD** Page 32
-  Union Nut
Type **FI-M** Page 33
-  37° Flared Tube Fitting Set
Type **FI-AB** Page 37

Male threaded studs were designed for female threaded ports in components made of steel. For applications with components made of softer mating materials (e.g. Aluminium), the use of connectors with additionally rolled male threads is recommended.

Please contact STAUFF prior to the assembly for further information.



**Straight Male Stud Fitting
Type FI-GE-...-R • Series S**

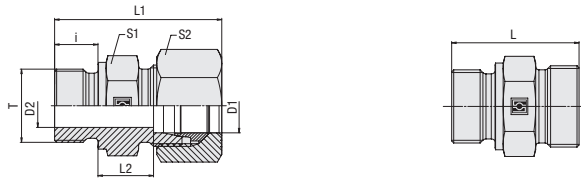

C

Metallic Sealing Edge

Whitworth Parallel Pipe Thread (BSPP)

Series	Tube OD mm	PN bar	Dimensions mm								Torque N-m	Weight kg ca. per 100	Ordering Codes ³
			Thread	T	D2	i	L	L1 ¹	L2	S1			
S	20	250	G 1/2	12	14	45	56	20,5	32	36	220	13,69	FI-GE-20SR1/2-W3
	20	250	G 3/4	16	16	47	58	20,5	32	36	350	15,24	FI-GE-20SR-W3
	20	250	G 1	16	18	51	62	22,5	41	36	700	25,90	FI-GE-20SR1-W3
	25	250	G 3/4	16	16	51	63	23	41	46	350	24,73	FI-GE-25SR3/4-W3
	25	250	G 1	20	18	53	65	23	41	46	700	26,89	FI-GE-25SR-W3
	25	250	G 1 1/4	20	20	55	67	23	50	46	850	23,28	FI-GE-25SR1-1/4-W3
	30	200	G 3/4	16	16	53	68	23,5	46	50	350	31,08	FI-GE-30SR3/4-W3
	30	200	G 1	20	18	55	68	23,5	46	50	700	33,52	FI-GE-30SR1-W3
	30	200	G 1 1/4	25	20	57	70	23,5	50	50	850	42,11	FI-GE-30SR-W3
	30	200	G 1 1/2	25	22	59	72	23,5	55	50	1000	57,10	FI-GE-30SR1-1/2-W3
	38	200	G 1	20	18	62	77	28	55	60	700	52,40	FI-GE-38SR1-W3
	38	200	G 1 1/4	25	20	62	75	26	55	60	850	57,22	FI-GE-38SR1-1/4-W3
	38	200	G 1 1/2	32	22	64	77	26	55	60	1000	56,30	FI-GE-38SR-W3

¹ Approx.imate dimension in assembled condition.

² Weight excluding cutting ring and union nut.

³ Standard scope of delivery: Fitting body only.

Male stud acc. to DIN 3852-2 (Form B) / ISO 1179-4 (Type B)
Port acc. to DIN 3852-2 (Form X) / ISO 1179-1

Torque recommendations for Steel mating material.

Male threaded studs were designed for female threaded ports in components made of steel. For applications with components made of softer mating materials (e.g. Aluminium), the use of connectors with additionally rolled male threads is recommended.

Please contact STAUFF prior to the assembly for further information.

Ordering Codes

***FI-GE*-10*S*R*-W3*-MS**

* Straight Male Stud Fitting	FI-GE
* Outside Tube Diameter D1 (in mm)	-10
* Series	Extra-Light Series (page 40) LL Light Series (pages 40/41) L Heavy Series (pages 42/43) S
* Thread Type	Whitworth Parallel Pipe Thread (BSPP) R
If required, please indicate special sizes, e.g. R1/8!	
* Material Code	Steel, zinc/nickel-plated -W3
Please contact STAUFF for alternative materials and surface finishings.	
* Assembling / Kitting	Fitting body only — Fitting body supplied with cutting ring and union nut -MS Fitting body supplied with soft-sealing cutting ring and union nut -MSV

Connecting Parts

	Cutting Ring Type FI-DS	Page 28
	Soft-Sealing Cutting Ring Type FI-WDDS	Page 29
	Support Sleeve Type FI-VH	Page 31
	STAUFF Form EVO Sealing Ring Type FI-FD	Page 32
	Union Nut Type FI-M	Page 33
	37° Flared Tube Fitting Set Type FI-AB	Page 37



Straight Male Stud Fitting
Type FI-GE-...-M • Series LL / L

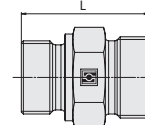
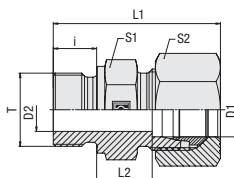

C

Metric Parallel Thread

Metallic Sealing Edge

Ordering Codes

***FI-GE*-10*L*M*-W3*-MS**

* Straight Male Stud Fitting		FI-GE
* Outside Tube Diameter D1 (in mm)		-10
* Series	Extra-Light Series (page 44)	LL
	Light Series (pages 44/45)	L
	Heavy Series (page 46)	S
* Thread Type	Metric Parallel Thread	M
If required, please indicate special sizes, e.g. M12x1.5!		
* Material Code	Steel, zinc/nickel-plated	-W3
Please contact STAUFF for alternative materials and surface finishings.		
* Assembling / Kitting	Fitting body only	—
	Fitting body supplied with cutting ring and union nut	-MS
	Fitting body supplied with soft-sealing cutting ring and union nut	-MSV

Series	Tube OD mm D1	PN bar	Dimensions mm										Torque N-m Thread T	Weight kg ca. per 100	Ordering Codes ³
			Thread T	D2	i	L	L1 ¹	L2	S1	S2					
LL	4	100	M 8 x 1	3	8	21,5	27	9,5	12	10	14	0,84	FI-GE-04LLM-W3		
	6	100	M 6 x 1	2	8	21,5	27	8	12	12	5	0,74	FI-GE-06LLM6x1-W3		
	6	100	M 8 x 1	3	8	21,5	27	8	12	12	14	0,88	FI-GE-06LLM8x1-W3		
	6	100	M 10 x 1	4,5	8	21,5	27	8	14	12	25	1,17	FI-GE-06LLM-W3		
L	8	100	M 10 x 1	5	8	22,5	28	9	14	14	25	1,25	FI-GE-08LLM-W3		
	6	100	M 8 x 1	3	8	23,5	31	8,5	14	14	14	1,29	FI-GE-06LM8x1-W3		
	6	400	M 10 x 1	4	8	23,5	31,5	8,5	14	14	25	1,38	FI-GE-06LM-W3		
	6	400	M 12 x 1,5	4	12	29	37	10	17	14	45	2,26	FI-GE-06LM12x1.5-W3		
	6	400	M 14 x 1,5	4	12	30	38	11	19	14	70	2,89	FI-GE-06LM14x1.5-W3		
	8	400	M 10 x 1	4	8	23,5	31,5	8,5	14	17	25	1,53	FI-GE-08LM10x1-W3		
	8	400	M 12 x 1,5	6	12	29	37	10	17	17	45	2,21	FI-GE-08LM-W3		
	8	400	M 14 x 1,5	6	12	30	38	11	19	17	70	3,11	FI-GE-08LM14x1.5-W3		
	8	400	M 16 x 1,5	6	12	30	38	11	22	17	90	4,05	FI-GE-08LM16x1.5-W3		
	8	400	M 18 x 1,5	6	12	30,5	38,5	11,5	24	17	120	4,34	FI-GE-08LM18x1.5-W3		
	8	400	M 22 x 1,5	14	14	34	40	13	27	17	170	6,46	FI-GE-08LM22x1.5-W3		
	10	400	M 10 x 1	4	8	25,5	33,5	1,5	17	19	25	2,20	FI-GE-10LM10x1-W3		
	10	400	M 12 x 1,5	6	12	30	38	11	17	19	45	2,38	FI-GE-10LM12x1.5-W3		
	10	400	M 14 x 1,5	7	12	30	38	11	19	19	70	2,94	FI-GE-10LM-W3		
	10	400	M 16 x 1,5	8	12	31,5	39,5	12,5	22	19	90	4,05	FI-GE-10LM16x1.5-W3		
	10	400	M 18 x 1,5	8	12	31,5	39,5	12,5	24	19	120	4,94	FI-GE-10LM18x1.5-W3		
	10	400	M 22 x 1,5	8	14	34	42	13	27	19	170	7,36	FI-GE-10LM22x1.5-W3		
	12	400	M 12 x 1,5	6	12	30	38	11	19	22	45	2,84	FI-GE-12LM12x1.5-W3		
	12	400	M 14 x 1,5	7	12	30	38	11	19	22	70	3,06	FI-GE-12LM14x1.5-W3		
	12	400	M 16 x 1,5	9	12	31,5	39,5	12,5	22	22	90	3,92	FI-GE-12LM-W3		
12	400	M 18 x 1,5	10	12	31,5	39,5	12,5	24	22	120	4,90	FI-GE-12LM18x1.5-W3			
12	400	M 22 x 1,5	10	14	35	43	14	27	22	170	6,96	FI-GE-12LM22x1.5-W3			

Connecting Parts

	Cutting Ring Type FI-DS	Page 28
	Soft-Sealing Cutting Ring Type FI-WDDS	Page 29
	Support Sleeve Type FI-VH	Page 31
	STAUFF Form EVO Sealing Ring Type FI-FD	Page 32
	Union Nut Type FI-M	Page 33
	37° Flared Tube Fitting Set Type FI-AB	Page 37

¹ Approximate dimension in assembled condition.

² Weight excluding cutting ring and union nut.

³ Standard scope of delivery: Fitting body only.

Male stud acc. to DIN 3852-1 (Form B) / ISO 9974-3 (Type B)
Port acc. to DIN 3852-1 (Form X) / ISO 9974-1

Torque recommendations for Steel mating material.

Male threaded studs were designed for female threaded ports in components made of steel. For applications with components made of softer mating materials (e.g. Aluminium), the use of connectors with additionally rolled male threads is recommended.

Please contact STAUFF prior to the assembly for further information.



**Straight Male Stud Fitting
Type FI-GE-...-M ▪ Series L**

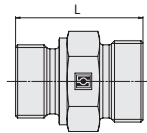
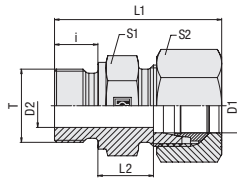

C

Metric Parallel Thread

Metallic Sealing Edge

Series	Tube OD mm	PN bar	Dimensions mm	Dimensions								Torque N-m	Weight kg ca.	Ordering Codes ³
L	D1		Thread T	D2	i	L	L1 ¹	L2	S1	S2	Thread T	per 100		
	15	400	M 16 x 1,5	9	12	32	40	13	24	27	90	5,15	FI-GE-15LM16x1.5-W3	
	15	400	M 18 x 1,5	11	12	32,5	4,5	13,5	24	27	120	5,28	FI-GE-15LM-W3	
	15	400	M 22 x 1,5	12	14	35	43	14	27	27	170	7,15	FI-GE-15LM22x1.5-W3	
	18	400	M 18 x 1,5	11	12	33,5	42,5	14	27	32	120	6,26	FI-GE-18LM18x1.5-W3	
	18	400	M 22 x 1,5	14	14	36	45	14,5	27	32	170	7,60	FI-GE-18LM-W3	
	18	250	M 26 x 1,5	15	16	38	47	14,5	32	32	230	10,88	FI-GE-18LM26x1.5-W3	
	22	250	M 22 x 1,5	14	14	38	47	16,5	32	36	170	9,10	FI-GE-22LM22x1.5-W3	
	22	250	M 26 x 1,5	18	16	40	49	16,5	32	36	230	10,34	FI-GE-22LM-W3	
	22	250	M 33 x 2	23	18	43	53	17,5	41	36	400	16,15	FI-GE-22LM33x2-W3	
	28	250	M 26 x 1,5	18	16	41	51	17,5	41	41	230	14,46	FI-GE-28LM26x1.5-W3	
	28	250	M 33 x 2	23	18	43	52	17,5	41	41	400	17,13	FI-GE-28LM-W3	
	35	200	M 42 x 2	30	20	48	59	17,5	50	50	700	27,85	FI-GE-35LM-W3	
	42	200	M 48 x 2	36	22	52	64	19	55	60	900	35,91	FI-GE-42LM-W3	

¹ Approx.imate dimension in assembled condition.

² Weight excluding cutting ring and union nut.

³ Standard scope of delivery: Fitting body only.

Male stud acc. to DIN 3852-1 (Form B) / ISO 9974-3 (Type B)

Port acc. to DIN 3852-1 (Form X) / ISO 9974-1

Torque recommendations for Steel mating material.

Male threaded studs were designed for female threaded ports in components made of steel. For applications with components made of softer mating materials (e.g. Aluminium), the use of connectors with additionally rolled male threads is recommended.

Please contact STAUFF prior to the assembly for further information.

Ordering Codes

***FI-GE*-10*L*M*-W3*-MS**

* Straight Male Stud Fitting	FI-GE
* Outside Tube Diameter D1 (in mm)	-10
* Series	Extra-Light Series (page 44) LL Light Series (pages 44/45) L Heavy Series (page 46) S
* Thread Type	Metric Parallel Thread M
If required, please indicate special sizes, e.g. M12x1.5!	
* Material Code	Steel, zinc/nickel-plated -W3
Please contact STAUFF for alternative materials and surface finishings.	
* Assembling / Kitting	Fitting body only — Fitting body supplied with cutting ring and union nut -MS Fitting body supplied with soft-sealing cutting ring and union nut -MSV

Connecting Parts

	Cutting Ring Type FI-DS	Page 28
	Soft-Sealing Cutting Ring Type FI-WDDS	Page 29
	Support Sleeve Type FI-VH	Page 31
	STAUFF Form EVO Sealing Ring Type FI-FD	Page 32
	Union Nut Type FI-M	Page 33
	37° Flared Tube Fitting Set Type FI-AB	Page 37



Straight Male Stud Fitting
Type FI-GE-...-M ▪ Series S

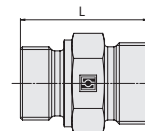
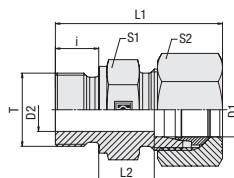

C

Metallic Sealing Edge

Metric Parallel Thread

Ordering Codes

***FI-GE*-10*S*M*-W3*-MS**

- * Straight Male Stud Fitting **FI-GE**
- * Outside Tube Diameter D1 (in mm) **-10**
- * Series **LL**
 Extra-Light Series (page 44)
L
 Light Series (pages 44/45)
S
 Heavy Series (page 46)
- * Thread Type **M**
 Metric Parallel Thread
- If required, please indicate special sizes, e.g. M12x1.5!
- * Material Code **-W3**
 Steel, zinc/nickel-plated
 Please contact STAUFF for alternative materials and surface finishings.
- * Assembling / Kitting **—**
 Fitting body only
 Fitting body supplied with cutting ring and union nut **-MS**
 Fitting body supplied with soft-sealing cutting ring and union nut **-MSV**

Series	Tube OD mm D1	PN bar	Dimensions mm										Torque N-m Thread T	Weight kg ca. per 100	Ordering Codes ³
			Thread	T	D2	i	L	L1 ¹	L2	S1	S2				
S	6	630	M 12 x 1,5	4	12	32	40	13	17	17	60	2,99	FI-GE-06SM-W3		
	8	630	M 14 x 1,5	5	12	34,5	42	15	19	19	80	4,26	FI-GE-08SM-W3		
	10	630	M 14 x 1,5	5	12	34,5	42	15	19	22	80	4,63	FI-GE-10SM14x1.5-W3		
	10	630	M 16 x 1,5	7	12	34,5	43,5	15	22	22	130	5,46	FI-GE-10SM-W3		
	10	630	M 18 x 1,5	7	12	36,5	45,5	17	24	22	190	7,66	FI-GE-10SM18x1.5-W3		
	10	630	M 22 x 1,5	12	14	39	47	17,5	27	22	300	9,18	FI-GE-10SM22x1.5-W3		
	12	630	M 14 x 1,5	5	12	36	45	17	22	24	80	6,00	FI-GE-12SM14x1.5-W3		
	12	630	M 16 x 1,5	7	12	24,5	48	17	22	24	130	6,12	FI-GE-12SM16x1.5-W3		
	12	630	M 18 x 1,5	8	12	36,5	45,5	17	24	24	190	7,19	FI-GE-12SM-W3		
	12	630	M 22 x 1,5	8	14	39	48	17,5	27	24	300	9,28	FI-GE-12SM22x1.5-W3		
	14	400	M 18 x 1,5	8	12	39	48	19	27	27	190	9,10	FI-GE-14SM18x1.5-W3		
	14	400	M 20 x 1,5	10	14	41	51	19	27	27	220	9,49	FI-GE-14SM-W3		
	16	400	M 18 x 1,5	8	12	38,5	48,5	18	27	30	190	7,82	FI-GE-16SM18x1.5-W3		
	16	400	M 22 x 1,5	12	14	41	51	18,5	27	30	300	9,75	FI-GE-16SM-W3		
	16	400	M 27 x 2	16	16	45	55	20,5	32	30	420	14,29	FI-GE-16SM27x2-W3		
	20	400	M 18 x 1,5	8	12	42,5	54	20	32	36	190	13,64	FI-GE-20SM18x1.5-W3		
	20	400	M 22 x 1,5	12	14	47	58	22,5	32	36	300	13,95	FI-GE-20SM22x1.5-W3		
	20	400	M 27 x 2	16	16	47	58	20,5	32	36	420	15,12	FI-GE-20SM-W3		
	25	400	M 33 x 2	20	18	53	65	23	41	46	600	26,71	FI-GE-25SM-W3		
	30	200	M 42 x 2	25	20	57	70	23,5	50	50	700	42,96	FI-GE-30SM-W3		
38	200	M 48 x 2	32	22	64	79	26	55	60	950	56,40	FI-GE-38SM-W3			

¹ Approx.imate dimension in assembled condition.

² Weight excluding cutting ring and union nut.

³ Standard scope of delivery: Fitting body only.

Male stud acc. to DIN 3852-1 (Form B) / ISO 9974-3 (Type B)
 Port acc. to DIN 3852-1 (Form X) / ISO 9974-1

Torque recommendations for Steel mating material.

Connecting Parts

-  Cutting Ring
Type **FI-DS** Page 28
-  Soft-Sealing Cutting Ring
Type **FI-WDDS** Page 29
-  Support Sleeve
Type **FI-VH** Page 31
-  STAUFF Form EVO Sealing Ring
Type **FI-FD** Page 32
-  Union Nut
Type **FI-M** Page 33
-  37° Flared Tube Fitting Set
Type **FI-AB** Page 37

Male threaded studs were designed for female threaded ports in components made of steel. For applications with components made of softer mating materials (e.g. Aluminium), the use of connectors with additionally rolled male threads is recommended.
 Please contact STAUFF prior to the assembly for further information.



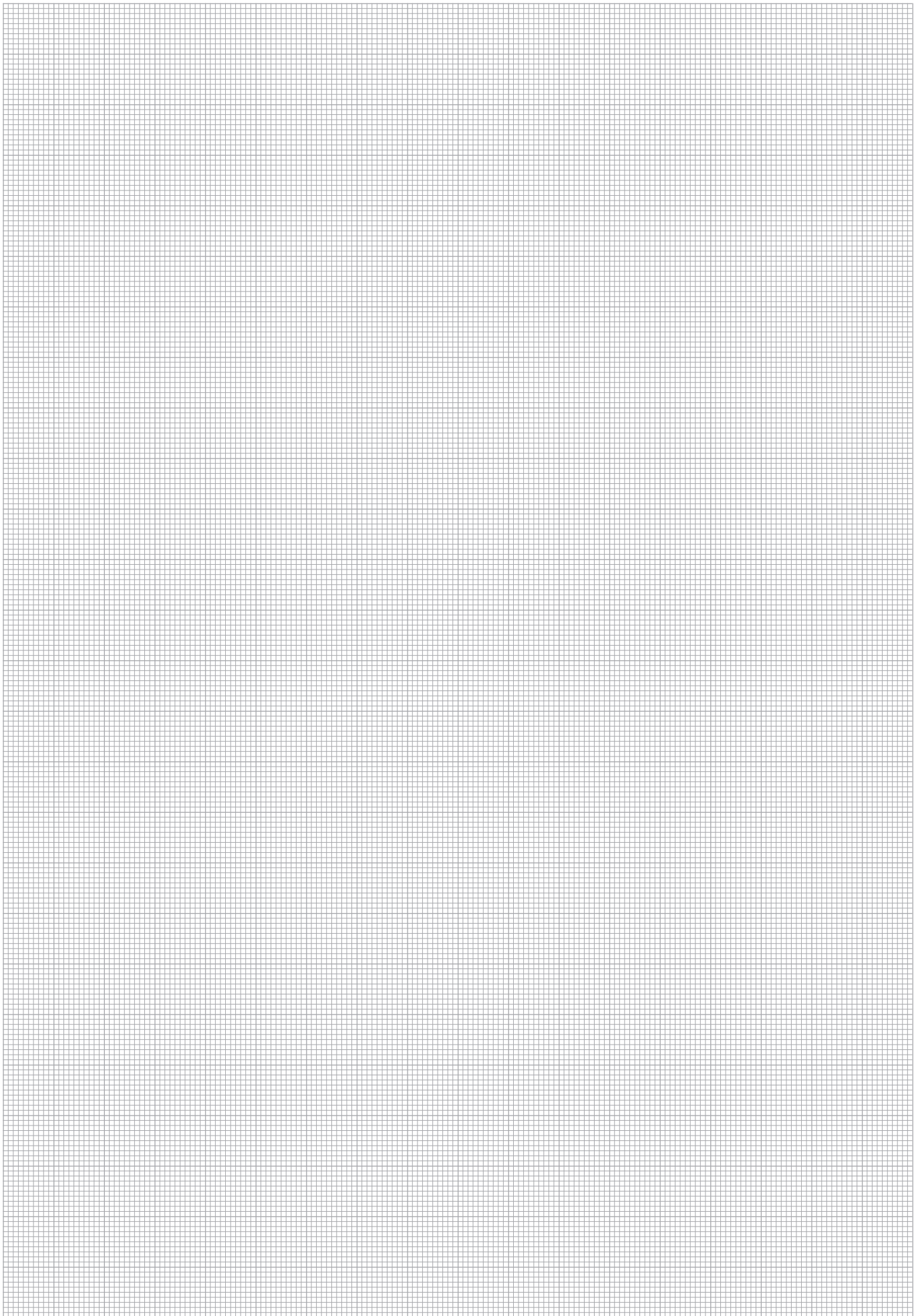

Straight Male Stud Fitting
Type FI-GE*...-R-WD ▪ Series LL / L

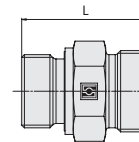
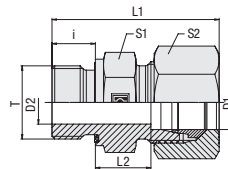

C

Whitworth Parallel Pipe Thread (BSPP)

Profile Sealing Ring

Ordering Codes

***FI-GE*-10*L*R*-WD*-B*-W3*-MS**

- * Straight Male Stud Fitting **FI-GE**
- * Outside Tube Diameter D1 (in mm) **-10**
- * Series Extra-Light Series (page 48) **LL**
 Light Series (pages 48/49) **L**
 Heavy Series (pages 50/51) **S**
- * Thread Type Whitworth Parallel Pipe Thread (BSPP) **R**
- If required, please indicate special sizes, e.g. R1/8!
- * Seal Type Profile Sealing Ring **-WD**
- * Seal Material NBR (Buna-N®) **-B**
 FKM (Viton®) **-V**
- * Material Code Steel, zinc/nickel-plated **-W3**
- Please contact STAUFF for alternative materials and surface finishings.
- * Assembling / Kitting Fitting body only **—**
 Fitting body supplied with cutting ring and union nut **-MS**
 Fitting body supplied with soft-sealing cutting ring and union nut **-MSV**

Series	Tube OD mm D1	PN bar	Dimensions mm									Torque N-m Thread T	Weight kg ca. per 100	Ordering Codes ³
			Thread T	D2	i	L	L1 ¹	L2	S1	S2				
LL	6	100	G 1/8	4	8	21,5	28	8	14	12	18	1,14	FI-GE-06LLR-WD-B-W3	
L	6	500	G 1/8	4	8	23,5	31,5	8,5	14	14	18	1,33	FI-GE-06LR-WD-B-W3	
	6	500	G 1/4	4	12	29	37	10	19	14	35	2,74	FI-GE-06LR1/4-WD-B-W3	
	6	400	G 3/8	4	12	30,5	38,5	11,5	22	14	70	4,03	FI-GE-06LR3/8-WD-B-W3	
	6	400	G 1/2	4	14	33	41	12	27	14	90	6,37	FI-GE-06LR1/2-WD-B-W3	
	8	500	G 1/8	4	8	24,5	32,5	9,5	14	17	18	1,61	FI-GE-08LR1/8-WD-B-W3	
	8	500	G 1/4	6	12	29	37	10	19	17	35	2,65	FI-GE-08LR-WD-B-W3	
	8	400	G 3/8	6	12	30,5	38,5	11,5	22	17	70	4,35	FI-GE-08LR3/8-WD-B-W3	
	8	400	G 1/2	6	14	33	41	12	27	17	90	6,58	FI-GE-08LR1/2-WD-B-W3	
	10	500	G 1/8	4	8	25,5	33,5	10,5	17	19	18	2,05	FI-GE-10LR1/8-WD-B-W3	
	10	500	G 1/4	6	12	30	38	11	19	19	35	2,88	FI-GE-10LR-WD-B-W3	
	10	500	G 3/8	8	12	31,5	39,5	12,5	22	19	70	4,15	FI-GE-10LR3/8-WD-B-W3	
	10	400	G 1/2	8	14	34	42	13	27	19	90	7,10	FI-GE-10LR1/2-WD-B-W3	
	12	400	G 1/8	4	8	26,5	34,5	11,5	19	22	18	2,55	FI-GE-12LR1/8-WD-B-W3	
	12	400	G 1/4	6	12	31	39	12	19	22	35	3,05	FI-GE-12LR1/4-WD-B-W3	
	12	400	G 3/8	9	12	31,5	39,5	12,5	22	22	70	4,14	FI-GE-12LR-WD-B-W3	
	12	400	G 1/2	10	14	34	42	13	27	22	90	6,65	FI-GE-12LR1/2-WD-B-W3	
	12	250	G 3/4	10	16	37	45	14	32	22	180	9,25	FI-GE-12LR3/4-WD-B-W3	
	15	400	G 1/4	7	12	31,5	39,5	12,5	22	27	35	4,07	FI-GE-15LR1/4-WD-B-W3	
	15	400	G 3/8	9	12	32,5	40,5	13,5	24	27	70	5,32	FI-GE-15LR3/8-WD-B-W3	
	15	400	G 1/2	12	14	35	43	14	27	27	90	6,62	FI-GE-15LR-WD-B-W3	
	15	250	G 3/4	12	16	38	46	15	32	27	180	11,80	FI-GE-15LR3/4-WD-B-W3	
	15	250	G 1	12	18	42,5	49	17,5	41	27	310	22,61	FI-GE-15LR1-WD-B-W3	

¹ Approximate dimension in assembled condition.

² Weight excluding cutting ring and union nut.

³ Standard scope of delivery: Fitting body only.

Male stud acc. to ISO 1179-2 (Type E)

Port acc. to ISO 1179-1

Torque recommendations for Steel mating material.

Standard seal material is NBR (Buna-N®).

Male threaded studs were designed for female threaded ports in components made of steel. For applications with components made of softer mating materials (e.g. Aluminium), the use of connectors with additionally rolled male threads is recommended.

Please contact STAUFF prior to the assembly for further information.

Connecting Parts

-  Cutting Ring
Type **FI-DS** Page 28
-  Soft-Sealing Cutting Ring
Type **FI-WDDS** Page 29
-  Support Sleeve
Type **FI-VH** Page 31
-  STAUFF Form EVO Sealing Ring
Type **FI-FD** Page 32
-  Union Nut
Type **FI-M** Page 33
-  37° Flared Tube Fitting Set
Type **FI-AB** Page 37

Spare Parts / Accessories

-  Profile Sealing Ring
Type **WDG** Page 238



Straight Male Stud Fitting
Type FI-GE-...-R-WD • Series L

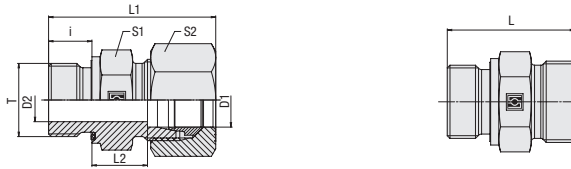

C

Profile Sealing Ring

Whitworth Parallel Pipe Thread (BSPP)

Series	Tube OD mm D1	PN bar	Dimensions mm Thread T D2 i L L1 ¹ L2 S1 S2	Torque N-m Thread T	Weight kg ca. per 100	Ordering Codes ³
L	18	400	G 3/8 9 12 33,5 42,5 14 27 32	70	6,56	FI-GE-18LR3/8-WD-B-W3
	18	400	G 1/2 14 14 36 45 14,5 27 32	90	7,01	FI-GE-18LR-WD-B-W3
	18	400	G 3/4 15 16 38 47 14,5 32 32	180	10,89	FI-GE-18LR3/4-WD-B-W3
	18	250	G 1 22 18 43 48 17,5 41 32	310	18,44	FI-GE-18LR1-WD-B-W3
	22	250	G 1/2 14 14 38 47 16,5 32 36	90	8,75	FI-GE-22LR1/2-WD-B-W3
	22	250	G 3/4 18 16 40 49 16,5 32 36	180	10,28	FI-GE-22LR-WD-B-W3
	22	250	G 1 19 18 43 52 17,5 41 36	310	18,57	FI-GE-22LR1-WD-B-W3
	22	250	G 1 1/4 30 20 46 55 18,5 50 36	450	26,41	FI-GE-22LR1-1/4-WD-B-W3
	28	250	G 3/4 18 16 41 50 17,5 41 41	180	14,97	FI-GE-28LR3/4-WD-B-W3
	28	250	G 1 23 18 43 52 17,5 41 41	310	15,83	FI-GE-28LR-WD-B-W3
	28	250	G 1 1/4 24 20 45 54 17,5 50 41	450	13,40	FI-GE-28LR1-1/4-WD-B-W3
	35	250	G 3/4 18 16 44 55 17 46 50	180	20,71	FI-GE-35LR3/4-WD-B-W3
	35	250	G 1 23 18 46 57 17,5 46 50	310	22,15	FI-GE-35LR1-WD-B-W3
	35	250	G 1 1/4 30 20 48 59 17,5 50 50	450	27,23	FI-GE-35LR-WD-B-W3
	35	250	G 1 1/2 30 22 52 63 19,5 55 50	540	42,18	FI-GE-35LR1-1/2-WD-B-W3
	42	250	G 1 23 18 48 60 19 55 60	310	31,72	FI-GE-42LR1-WD-B-W3
	42	250	G 1 1/4 30 20 50 62 19 55 60	450	34,03	FI-GE-42LR1-1/4-WD-B-W3
	42	250	G 1 1/2 36 22 52 64 19 55 60	540	34,37	FI-GE-42LR-WD-B-W3

¹ Approximate dimension in assembled condition.

² Weight excluding cutting ring and union nut.

³ Standard scope of delivery: Fitting body only.

Male stud acc. to ISO 1179-2 (Type E)

Port acc. to ISO 1179-1

Torque recommendations for Steel mating material.

Standard seal material is NBR (Buna-N®).

Male threaded studs were designed for female threaded ports in components made of steel. For applications with components made of softer mating materials (e.g. Aluminium), the use of connectors with additionally rolled male threads is recommended.

Please contact STAUFF prior to the assembly for further information.

Ordering Codes

***FI-GE*-10*L*R*-WD*-B*-W3*-MS**

* Straight Male Stud Fitting	FI-GE
* Outside Tube Diameter D1 (in mm)	-10
* Series	Extra-Light Series (page 48) LL Light Series (pages 48/49) L Heavy Series (pages 50/51) S
* Thread Type	Whitworth Parallel Pipe Thread (BSPP) R
If required, please indicate special sizes, e.g. R1/8!	
* Seal Type	Profile Sealing Ring -WD
* Seal Material	NBR (Buna-N®) -B FKM (Viton®) -V
* Material Code	Steel, zinc/nickel-plated -W3
Please contact STAUFF for alternative materials and surface finishings.	
* Assembling / Kitting	Fitting body only — Fitting body supplied with cutting ring and union nut -MS Fitting body supplied with soft-sealing cutting ring and union nut -MSV

Connecting Parts

	Cutting Ring Type FI-DS	Page 28
	Soft-Sealing Cutting Ring Type FI-WDDS	Page 29
	Support Sleeve Type FI-VH	Page 31
	STAUFF Form EVO Sealing Ring Type FI-FD	Page 32
	Union Nut Type FI-M	Page 33
	37° Flared Tube Fitting Set Type FI-AB	Page 37

Spare Parts / Accessories

	Profile Sealing Ring Type WDG	Page 238
--	----------------------------------	----------



Straight Male Stud Fitting
Type FI-GE-...-R-WD ■ Series S

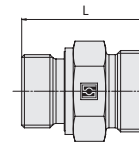
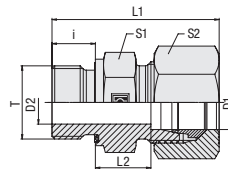

C

Whitworth Parallel Pipe Thread (BSPP)

Profile Sealing Ring

Ordering Codes

***FI-GE*-10*S*R*-WD*-B*-W3*-MS**

- * Straight Male Stud Fitting **FI-GE**
- * Outside Tube Diameter D1 (in mm) **-10**
- * Series **LL**
 Extra-Light Series (page 48)
L Light Series (pages 48/49)
S Heavy Series (pages 50/51)
- * Thread Type **R**
 Whitworth Parallel
 Pipe Thread (BSPP)
- If required, please indicate special sizes, e.g. R1/8!
- * Seal Type **-WD**
 Profile Sealing Ring
- * Seal Material **-B**
 NBR (Buna-N®)
-V FKM (Viton®)
- * Material Code **-W3**
 Steel, zinc/nickel-plated
- Please contact STAUFF for alternative materials and surface finishings.
- * Assembling / Kitting **—**
 Fitting body only
- Fitting body supplied with cutting ring and union nut **-MS**
- Fitting body supplied with soft-sealing cutting ring and union nut **-MSV**

Series	Tube OD mm D1	PN bar	Dimensions mm									Torque N-m Thread T	Weight kg ca. per 100	Ordering Codes ³
			Thread T	D2	i	L	L1 ¹	L2	S1	S2				
S	6	800	G 1/8	4	8	27,5	35,5	12,5	17	17	25	2,49	FI-GE-06SR1/8-WD-B-W3	
	6	800	G 1/4	4	12	32	40	13	19	17	55	3,46	FI-GE-06SR-WD-B-W3	
	6	800	G 3/8	4	12	34,5	42,5	15,5	22	17	80	5,63	FI-GE-06SR3/8-WD-B-W3	
	6	800	G 1/2	4	14	39	47	18	27	17	115	8,22	FI-GE-06SR1/2-WD-B-W3	
	8	800	G 1/8	4	8	29,5	37,5	14,5	19	19	25	3,41	FI-GE-08SR1/8-WD-B-W3	
	8	800	G 1/4	5	12	34	42	15	19	19	55	4,00	FI-GE-08SR-WD-B-W3	
	8	800	G 3/8	5	12	34,5	42,5	15,5	22	19	80	5,72	FI-GE-08SR3/8-WD-B-W3	
	8	800	G 1/2	5	14	39	47	18	27	19	115	9,92	FI-GE-08SR1/2-WD-B-W3	
	10	800	G 1/4	5	12	34	43	14,5	19	22	55	4,22	FI-GE-10SR1/4-WD-B-W3	
	10	800	G 3/8	7	12	34,5	43,5	15	22	22	80	5,60	FI-GE-10SR-WD-B-W3	
	10	800	G 1/2	7	14	39	47	17,5	27	22	115	9,57	FI-GE-10SR1/2-WD-B-W3	
	12	630	G 1/4	5	12	36	44	16,5	22	24	55	5,60	FI-GE-12SR1/4-WD-B-W3	
	12	630	G 3/8	8	12	36,5	45	17	22	24	80	6,25	FI-GE-12SR-WD-B-W3	
	12	630	G 1/2	8	14	39	48	17,5	27	24	115	9,52	FI-GE-12SR1/2-WD-B-W3	
	12	630	G 3/4	8	16	41	50	17,5	32	24	180	12,83	FI-GE-12SR3/4-WD-B-W3	
	14	630	G 3/8	8	12	38,5	48,5	18,5	24	27	80	5,03	FI-GE-14SR3/8-WD-B-W3	
	14	630	G 1/2	10	14	41	51	19	27	27	115	9,67	FI-GE-14SR-WD-B-W3	
	14	630	G 3/4	10	16	45	55	21	32	27	180	14,90	FI-GE-14SR3/4-WD-B-W3	
	16	630	G 1/4	7	12	38	48	17,5	27	30	55	8,12	FI-GE-16SR1/4-WD-B-W3	
	16	630	G 3/8	8	12	38,5	48,5	18	27	30	80	7,53	FI-GE-16SR3/8-WD-B-W3	
	16	630	G 1/2	12	14	41	51	18,5	27	30	115	9,08	FI-GE-16SR-WD-B-W3	
	16	630	G 3/4	12	16	45	55	20,5	32	30	180	15,51	FI-GE-16SR3/4-WD-B-W3	
	16	420	G 1	12	18	49	59	22,5	41	30	310	25,20	FI-GE-16SR1-WD-B-W3	

¹ Approximate dimension in assembled condition.

² Weight excluding cutting ring and union nut.

³ Standard scope of delivery: Fitting body only.

Male stud acc. to ISO 1179-2 (Type E)

Port acc. to ISO 1179-1

Torque recommendations for Steel mating material.

Standard seal material is NBR (Buna-N®).

Male threaded studs were designed for female threaded ports in components made of steel. For applications with components made of softer mating materials (e.g. Aluminium), the use of connectors with additionally rolled male threads is recommended.

Please contact STAUFF prior to the assembly for further information.

Connecting Parts

- Cutting Ring
Type **FI-DS** Page 28
- Soft-Sealing Cutting Ring
Type **FI-WDDS** Page 29
- Support Sleeve
Type **FI-VH** Page 31
- STAUFF Form EVO Sealing Ring
Type **FI-FD** Page 32
- Union Nut
Type **FI-M** Page 33
- 37° Flared Tube Fitting Set
Type **FI-AB** Page 37

Spare Parts / Accessories

- Profile Sealing Ring
Type **WDG** Page 238



Straight Male Stud Fitting
Type FI-GE-...-R-WD ▪ Series S

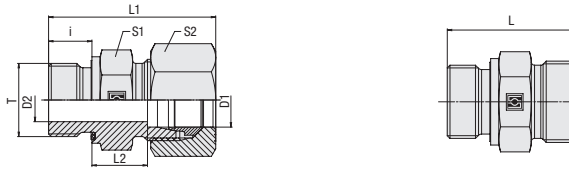

C

Profile Sealing Ring

Whitworth Parallel Pipe Thread (BSPP)

Series	Tube OD mm D1	PN bar	Dimensions mm								Torque N-m Thread T	Weight kg ca. per 100	Ordering Codes ³
			Thread	T	D2	i	L	L1 ¹	L2	S1			
S	20	420	G 1/2	12	14	45	56	20,5	32	36	115	13,76	FI-GE-20SR1/2-WD-B-W3
	20	420	G 3/4	16	16	47	58	20,5	32	36	180	14,86	FI-GE-20SR-WD-B-W3
	20	420	G 1	16	18	51	62	22,5	41	36	310	21,90	FI-GE-20SR1-WD-B-W3
	20	420	G 1 1/4	16	20	53	64	22,5	50	36	450	13,50	FI-GE-20SR1-1/4-WD-B-W3
	25	400	G 1/2	12	14	49	61	23	41	46	115	23,49	FI-GE-25SR1/2-WD-B-W3
	25	420	G 3/4	16	16	51	63	23	41	46	180	20,33	FI-GE-25SR3/4-WD-B-W3
	25	420	G 1	20	18	53	65	23	41	46	310	26,75	FI-GE-25SR-WD-B-W3
	25	420	G 1 1/4	20	20	55	67	23	50	46	450	23,28	FI-GE-25SR1-1/4-WD-B-W3
	25	420	G 1 1/2	32	22	60	73,5	26	55	46	540	54,35	FI-GE-25SR1-1/2-WD-B-W3
	30	420	G 3/4	16	16	53	66	23,5	46	50	180	31,16	FI-GE-30SR3/4-WD-B-W3
	30	420	G 1	20	18	55	68	23,5	46	50	310	33,20	FI-GE-30SR1-WD-B-W3
	30	420	G 1 1/4	25	20	57	70	23,5	50	50	450	41,74	FI-GE-30SR-WD-B-W3
	30	315	G 1 1/2	25	22	62	75	26,5	55	50	540	54,30	FI-GE-30SR1-1/2-WD-B-W3
	38	420	G 3/4	16	16	58	73	26	55	60	180	50,1	FI-GE-38SR3/4-WD-B-W3
	38	420	G 1	20	18	60	75	26	55	50	310	52,00	FI-GE-38SR1-WD-B-W3
	38	420	G 1 1/4	25	20	62	77	26	55	60	450	57,22	FI-GE-38SR1-1/4-WD-B-W3
	38	420	G 1 1/2	32	22	64	79	26	55	60	540	55,90	FI-GE-38SR-WD-B-W3
	38	250	G 2	32	24	66,5	81,5	26,5	75	60	750	98,3	FI-GE-38SR2-WD-B-W3

¹ Approximate dimension in assembled condition.

² Weight excluding cutting ring and union nut.

³ Standard scope of delivery: Fitting body only.

Male stud acc. to ISO 1179-2 (Type E)

Port acc. to ISO 1179-1

Torque recommendations for Steel mating material.

Standard seal material is NBR (Buna-N®).

Male threaded studs were designed for female threaded ports in components made of steel. For applications with components made of softer mating materials (e.g. Aluminium), the use of connectors with additionally rolled male threads is recommended.

Please contact STAUFF prior to the assembly for further information.

Ordering Codes

***FI-GE*-10*S*R*-WD*-B*-W3*-MS**

* Straight Male Stud Fitting	FI-GE
* Outside Tube Diameter D1 (in mm)	-10
* Series	Extra-Light Series (page 48) LL Light Series (pages 48/49) L Heavy Series (pages 50/51) S
* Thread Type	Whitworth Parallel Pipe Thread (BSPP) R
If required, please indicate special sizes, e.g. R1/8!	
* Seal Type	Profile Sealing Ring -WD
* Seal Material	NBR (Buna-N®) -B FKM (Viton®) -V
* Material Code	Steel, zinc/nickel-plated -W3
Please contact STAUFF for alternative materials and surface finishings.	
* Assembling / Kitting	Fitting body only —
	Fitting body supplied with cutting ring and union nut -MS
	Fitting body supplied with soft-sealing cutting ring and union nut -MSV

Connecting Parts

	Cutting Ring Type FI-DS	Page 28
	Soft-Sealing Cutting Ring Type FI-WDDS	Page 29
	Support Sleeve Type FI-VH	Page 31
	STAUFF Form EVO Sealing Ring Type FI-FD	Page 32
	Union Nut Type FI-M	Page 33
	37° Flared Tube Fitting Set Type FI-AB	Page 37

Spare Parts / Accessories

	Profile Sealing Ring Type WDG	Page 238
--	----------------------------------	----------



Straight Male Stud Fitting
Type FI-GE*...-M-WD ▪ Series L

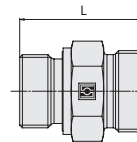
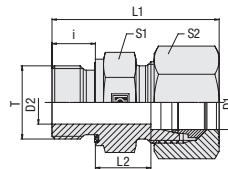

C

Metric Parallel Thread

Profile Sealing Ring

Ordering Codes

***FI-GE*-10*L*M*-WD*-B*-W3*-MS**

- * Straight Male Stud Fitting **FI-GE**
- * Outside Tube Diameter D1 (in mm) **-10**
- * Series Light Series (pages 52/53) **L**
Heavy Series (page 54) **S**
- * Thread Type Metric Parallel Thread **M**
If required, please indicate special sizes, e.g. M12x1.5!
- * Seal Type Profile Sealing Ring **-WD**
- * Seal Material NBR (Buna-N®) **-B**
FKM (Viton®) **-V**
- * Material Code Steel, zinc/nickel-plated **-W3**
Please contact STAUFF for alternative materials and surface finishings.
- * Assembling / Kitting Fitting body only **—**
Fitting body supplied with cutting ring and union nut **-MS**
Fitting body supplied with soft-sealing cutting ring and union nut **-MSV**

Series	Tube OD mm D1	PN bar	Dimensions mm										Torque N·m Thread T	Weight kg ca. per 100	Ordering Codes ³
			Thread	T	D2	i	L	L1 ¹	L2	S1	S2				
L	6	500	M 10 x 1	4	8	23,5	31,5	8,5	14	14	18	1,36	FI-GE-06LM-WD-B-W3		
	6	500	M 12 x 1,5	4	12	29	37	10	17	14	25	2,26	FI-GE-06LM12x1.5-WD-B-W3		
	8	500	M 10 x 1	4	8	23,5	31,5	8,5	14	17	18	1,54	FI-GE-08LM10x1-WD-B-W3		
	8	500	M 12 x 1,5	6	12	29	37	10	17	17	25	2,16	FI-GE-08LM-WD-B-W3		
	8	500	M 14 x 1,5	6	12	29	37	10	19	17	45	3,11	FI-GE-08LM14x1.5-WD-B-W3		
	8	400	M 16 x 1,5	6	12	30	38	11	22	17	55	4,05	FI-GE-08LM16x1.5-WD-B-W3		
	8	400	M 18 x 1,5	11	12	30,5	37	11,5	24	17	70	4,34	FI-GE-08LM18x1.5-WD-B-W3		
	8	400	M 22 x 1,5	14	14	34	41	13	27	17	125	7,66	FI-GE-08LM22x1.5-WD-B-W3		
	10	500	M 10 x 1	4	8	25,5	33	10,5	17	19	18	2,14	FI-GE-10LM10x1-WD-B-W3		
	10	500	M 12 x 1,5	6	12	30	38	11	17	19	25	2,38	FI-GE-10LM12x1.5-WD-B-W3		
	10	500	M 14 x 1,5	7	12	30	38	11	19	19	45	2,88	FI-GE-10LM-WD-B-W3		
	10	500	M 16 x 1,5	8	12	31,5	39,5	12,5	22	19	55	4,05	FI-GE-10LM16x1.5-WD-B-W3		
	10	500	M 18 x 1,5	8	12	31,5	39,5	12,5	24	19	70	4,94	FI-GE-10LM18x1.5-WD-B-W3		
	10	400	M 22 x 1,5	8	14	34	42	13	27	19	125	7,36	FI-GE-10LM22x1.5-WD-B-W3		
	12	400	M 10 x 1	4	8	25,5	33	10,5	17	19	18	2,38	FI-GE-12LM10x1-WD-B-W3		
	12	400	M 12 x 1,5	4	12	32	40	11	19	22	25	2,84	FI-GE-12LM12x1.5-WD-B-W3		
	12	400	M 14 x 1,5	7	12	30	38	11	19	22	45	3,06	FI-GE-12LM14x1.5-WD-B-W3		
	12	400	M 16 x 1,5	9	12	31,5	39,5	12,5	22	22	55	3,94	FI-GE-12LM-WD-B-W3		
	12	400	M 18 x 1,5	10	12	31,5	39,5	12,5	24	22	70	4,90	FI-GE-12LM18x1.5-WD-B-W3		
	12	400	M 22 x 1,5	10	14	35	42	14	27	22	125	6,96	FI-GE-12LM22x1.5-WD-B-W3		
15	400	M 16 x 1,5	9	12	32,5	40,5	13,5	24	27	55	5,15	FI-GE-15LM16x1.5-WD-B-W3			
15	400	M 18 x 1,5	11	12	32,5	40,5	13,5	24	27	70	5,05	FI-GE-15LM-WD-B-W3			
15	400	M 22 x 1,5	12	14	35	43	14	27	27	125	7,15	FI-GE-15LM22x1.5-WD-B-W3			
15	250	M 26 x 1,5	18	16	38	46	15	32	27	180	9,56	FI-GE-15LM26x1.5-WD-B-W3			

¹ Approx.imate dimension in assembled condition.

² Weight excluding cutting ring and union nut.

³ Standard scope of delivery: Fitting body only.

Standard seal material is NBR (Buna-N®).

Male stud acc. to ISO 9974-2 (Type E)

Port acc. to ISO 9974-1

Torque recommendations for Steel mating material.

Male threaded studs were designed for female threaded ports in components made of steel. For applications with components made of softer mating materials (e.g. Aluminium), the use of connectors with additionally rolled male threads is recommended.

Please contact STAUFF prior to the assembly for further information.

Connecting Parts

-  Cutting Ring Type **FI-DS** Page 28
-  Soft-Sealing Cutting Ring Type **FI-WDDS** Page 29
-  Support Sleeve Type **FI-VH** Page 31
-  STAUFF Form EVO Sealing Ring Type **FI-FD** Page 32
-  Union Nut Type **FI-M** Page 33
-  37° Flared Tube Fitting Set Type **FI-AB** Page 37

Spare Parts / Accessories

-  Profile Sealing Ring Type **WDG** Page 238



Straight Male Stud Fitting
Type FI-GE-...-M-WD ▪ Series L

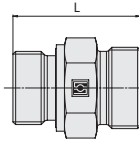
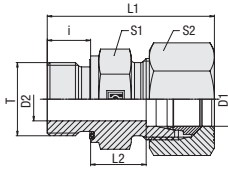

C

Metric Parallel Thread

Profile Sealing Ring

Series	Tube OD mm	PN bar	Dimensions mm								Torque N-m	Weight kg ca. per 100	Ordering Codes ³
			Thread	T	D2	i	L	L1 ¹	L2	S1			
L	18	400	M 18 x 1,5	11	12	33,5	42,5	14	27	32	70	6,26	FI-GE-18LM18x1.5-WD-B-W3
	18	400	M 22 x 1,5	14	14	36	45	14,5	27	32	125	7,43	FI-GE-18LM-WD-B-W3
	18	250	M 26 x 1,5	15	16	38	47	16	32	32	180	10,88	FI-GE-18LM26x1.5-WD-B-W3
	18	250	M 27 x 2	15	16	38	47	14,5	32	32	180	11,17	FI-GE-18LM27x2-WD-B-W3
	18	250	M 33 x 2	15	18	41	49	15,5	41	32	310	13,17	FI-GE-18LM33x2-WD-B-W3
	18	250	M 18 x 1,5	15	12	35,5	44	16	32	36	70	8,00	FI-GE-22LM18x1.5-WD-B-W3
	22	250	M 22 x 1,5	14	14	38	47	16,5	32	36	125	9,10	FI-GE-22LM22x1.5-WD-B-W3
	22	250	M 26 x 1,5	18	16	40	49	16,5	32	36	180	10,23	FI-GE-22LM-WD-B-W3
	22	250	M 27 x 2	18	16	40	50	16,5	32	36	180	10,45	FI-GE-22LM27x2-WD-B-W3
	22	250	M 33 x 2	23	18	43	52	17,5	41	36	310	16,15	FI-GE-22LM33x2-WD-B-W3
	28	250	M 26 x 1,5	18	16	41	50	17,5	41	41	180	14,39	FI-GE-28LM26x1.5-WD-B-W3
	28	250	M 33 x 2	23	18	43	52	17,5	41	41	310	16,76	FI-GE-28LM-WD-B-W3
	28	250	M 42 x 2	30	20	46	55	18,5	50	41	450	26,5	FI-GE-28LM42x2-WD-B-W3
	35	250	M 33 x 2	23	18	46	57	17,5	46	50	310	21,56	FI-GE-35LM33x2-WD-B-W3
	35	250	M 42 x 2	30	20	48	59	17,5	50	50	450	27,63	FI-GE-35LM-WD-B-W3
	42	250	M 42 x 2	30	20	50	61	19	55	60	450	21,09	FI-GE-42LM42x2-WD-B-W3
42	250	M 48 x 2	36	22	52	64	19	55	60	540	34,63	FI-GE-42LM-WD-B-W3	

¹ Approx.imate dimension in assembled condition.

² Weight excluding cutting ring and union nut.

³ Standard scope of delivery: Fitting body only.

Standard seal material is NBR (Buna-N®).

Male stud acc. to ISO 9974-2 (Type E)

Port acc. to ISO 9974-1

Torque recommendations for Steel mating material.

Male threaded studs were designed for female threaded ports in components made of steel. For applications with components made of softer mating materials (e.g. Aluminium), the use of connectors with additionally rolled male threads is recommended.

Please contact STAUFF prior to the assembly for further information.

Ordering Codes

***FI-GE*-10*L*M*-WD*-B*-W3*-MS**

* Straight Male Stud Fitting	FI-GE
* Outside Tube Diameter D1 (in mm)	-10
* Series	Light Series (pages 52/53) L Heavy Series (page 54) S
* Thread Type	Metric Parallel Thread M
If required, please indicate special sizes, e.g. M12x1.5!	
* Seal Type	Profile Sealing Ring -WD
* Seal Material	NBR (Buna-N®) -B FKM (Viton®) -V
* Material Code	Steel, zinc/nickel-plated -W3
Please contact STAUFF for alternative materials and surface finishings.	
* Assembling / Kitting	Fitting body only — Fitting body supplied with cutting ring and union nut -MS Fitting body supplied with soft-sealing cutting ring and union nut -MSV

Connecting Parts

	Cutting Ring Type FI-DS	Page 28
	Soft-Sealing Cutting Ring Type FI-WDDS	Page 29
	Support Sleeve Type FI-VH	Page 31
	STAUFF Form EVO Sealing Ring Type FI-FD	Page 32
	Union Nut Type FI-M	Page 33
	37° Flared Tube Fitting Set Type FI-AB	Page 37

Spare Parts / Accessories

	Profile Sealing Ring Type WDG	Page 238
--	---	----------



Straight Male Stud Fitting
Type FI-GE*...-M-WD ▪ Series S

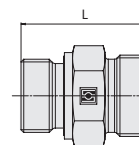
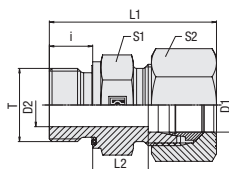

C

Ordering Codes

***FI-GE*-10*S*M*-WD*-B*-W3*-MS**

- * Straight Male Stud Fitting FI-GE
- * Outside Tube Diameter D1 (in mm) -10
- * Series L
Light Series (pages 52/53)
S
Heavy Series (page 54)
- * Thread Type M
Metric Parallel Thread
- If required, please indicate special sizes, e.g. M12x1.5!
- * Seal Type -WD
Profile Sealing Ring
- * Seal Material -B
NBR (Buna-N®)
-V
FKM (Viton®)
- * Material Code -W3
Steel, zinc/nickel-plated
- Please contact STAUFF for alternative materials and surface finishings.
- * Assembling / Kitting —
Fitting body only
- Fitting body supplied with cutting ring and union nut -MS
- Fitting body supplied with soft-sealing cutting ring and union nut -MSV

Profile Sealing Ring

Metric Parallel Thread

Series	Tube OD mm D1	PN bar	Dimensions mm										Torque N-m Thread T	Weight kg ca. per 100	Ordering Codes ³
			Thread	T	D2	i	L	L1 ¹	L2	S1	S2				
S	6	800	M 12 x 1,5	4	12	32	40	13	17	17	35	2,93	FI-GE-06SM-WD-B-W3		
	8	800	M 12 x 1,5	4	12	34	41	14,5	19	19	35	3,18	FI-GE-08SM12x1.5-WD-B-W3		
	8	800	M 14 x 1,5	5	12	34	42	15	19	19	55	4,16	FI-GE-08SM-WD-B-W3		
	10	800	M 14 x 1,5	5	12	34,5	43,5	15	19	22	55	4,97	FI-GE-10SM14x1.5-WD-B-W3		
	10	800	M 16 x 1,5	7	12	34,5	43,5	15	22	22	70	5,36	FI-GE-10SM-WD-B-W3		
	12	800	M 14 x 1,5	5	12	36	45	16,5	22	24	55	6,00	FI-GE-12SM14x1.5-WD-B-W3		
	12	800	M 16 x 1,5	8	12	36	45	16,5	22	24	70	6,12	FI-GE-12SM16x1.5-WD-B-W3		
	12	630	M 18 x 1,5	8	12	36,5	45,5	17	24	24	90	7,12	FI-GE-12SM-WD-B-W3		
	12	630	M 22 x 1,5	8	14	39	48	17,5	27	24	135	9,28	FI-GE-12SM22x1.5-WD-B-W3		
	14	630	M 20 x 1,5	10	14	41	51	19	27	27	125	9,46	FI-GE-14SM-WD-B-W3		
	16	630	M 18 x 1,5	8	12	38,5	48,5	18	24	30	90	7,82	FI-GE-16SM18x1.5-WD-B-W3		
	16	630	M 22 x 1,5	12	14	41	51	18,5	27	30	135	9,52	FI-GE-16SM-WD-B-W3		
	16	420	M 27 x 2	12	16	43	53	18,5	32	30	180	14,46	FI-GE-16SM27x2-WD-B-W3		
	20	420	M 22 x 1,5	12	14	45	56	20,5	32	36	135	14,03	FI-GE-20SM22x1.5-WD-B-W3		
	20	420	M 27 x 2	16	16	47	58	20,5	32	36	180	15,10	FI-GE-20SM-WD-B-W3		
	25	420	M 26 x 1,5	15	16	51	62	23	41	46	180	24,27	FI-GE-25SM26x1.5-WD-B-W3		
	25	420	M 27 x 2	16	16	51	62	23	41	46	180	24,42	FI-GE-25SM27x2-WD-B-W3		
	25	420	M 33 x 2	20	18	53	65	23	41	46	310	26,43	FI-GE-25SM-WD-B-W3		
	30	420	M 33 x 2	20	18	55	68	23,5	50	50	310	37,1	FI-GE-30SM33x2-WD-B-W3		
	30	420	M 42 x 2	25	20	57	70	23,5	50	50	450	41,84	FI-GE-30SM-WD-B-W3		
38	420	M 48 x 2	32	22	64	79	26	55	60	540	57,00	FI-GE-38SM-WD-B-W3			

¹ Approximate dimension in assembled condition.

² Weight excluding cutting ring and union nut.

³ Standard scope of delivery: Fitting body only.

Male stud acc. to ISO 9974-2 (Type E)

Port acc. to ISO 9974-1

Torque recommendations for Steel mating material.

Standard seal material is NBR (Buna-N®).

Connecting Parts

- Cutting Ring
Type **FI-DS** Page 28
- Soft-Sealing Cutting Ring
Type **FI-WDDS** Page 29
- Support Sleeve
Type **FI-VH** Page 31
- STAUFF Form EVO Sealing Ring
Type **FI-FD** Page 32
- Union Nut
Type **FI-M** Page 33
- 37° Flared Tube Fitting Set
Type **FI-AB** Page 37

Male threaded studs were designed for female threaded ports in components made of steel. For applications with components made of softer mating materials (e.g. Aluminium), the use of connectors with additionally rolled male threads is recommended.

Please contact STAUFF prior to the assembly for further information.

Spare Parts / Accessories

- Profile Sealing Ring
Type **WDG** Page 238

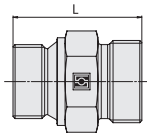
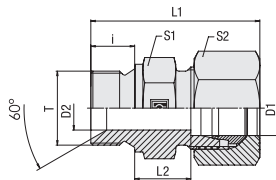

**Straight Male Stud Fitting
Type FI-GE-...-R-DF • Series L**

C
Whitworth Parallel Pipe Thread (BSPP)
60° Conical Bore / Sealing Surface for Gaskets

Series	Tube OD mm	PN bar	Dimensions mm		Dimensions								Torque N-m	Weight kg ca.	Ordering Codes ³
L	D1		Thread	T	D2	i	L	L1 ¹	L2	S1	S2	Thread T	per 100		
	6	250	G 1/8	3,5	8	23,5	31,5	8,5	14	14	20	1,38	FI-GE-06LR-DF-W3		
	6	250	G 1/4	4	12	29	36	10	19	14	50	2,75	FI-GE-06LR1/4-DF-W3		
	6	250	G 3/8	7,9	12	30,5	38	11	22	14	80	3,94	FI-GE-06LR3/8-DF-W3		
	8	250	G 1/8	3,5	8	24,5	32	10	14	17	20	1,71	FI-GE-08LR1/8-DF-W3		
	8	250	G 1/4	4,7	12	29	37	10	19	17	50	2,87	FI-GE-08LR-DF-W3		
	8	250	G 3/8	6	12	30,5	38	11	22	17	80	4,28	FI-GE-08LR3/8-DF-W3		
	10	250	G 1/4	4,7	12	30	38	11	19	19	50	2,82	FI-GE-10LR-DF-W3		
	10	250	G 3/8	7,9	12	31,5	39	12,5	22	19	80	4,18	FI-GE-10LR3/8-DF-W3		
	10	160	G 1/2	11,1	14	34	41	13	27	19	140	6,28	FI-GE-10LR1/2-DF-W3		
	12	250	G 1/4	4,7	12	31	39	12	19	22	50	3,30	FI-GE-12LR1/4-DF-W3		
	12	250	G 3/8	7,9	12	31,5	39,5	12,5	22	22	80	4,39	FI-GE-12LR-DF-W3		
	12	160	G 1/2	10	14	34	42	13	27	22	140	6,47	FI-GE-12LR1/2-DF-W3		
	15	250	G 3/8	7,9	12	32,5	40	13,5	24	27	80	5,18	FI-GE-15LR3/8-DF-W3		
	15	160	G 1/2	11,1	14	35	40,5	14	27	27	140	6,98	FI-GE-15LR-DF-W3		
	18	250	G 3/8	7,9	12	33,5	41	14	27	32	80	4,90	FI-GE-18LR3/8-DF-W3		
	18	160	G 1/2	11,1	14	35	45	13,5	27	32	140	5,35	FI-GE-18LR-DF-W3		
	18	160	G 3/4	15	16	38	47	14,5	32	32	190	10,79	FI-GE-18LR3/4-DF-W3		
	22	160	G 1/2	11,1	14	38	47	16,5	32	36	140	9,53	FI-GE-22LR1/2-DF-W3		
	22	160	G 3/4	16,7	16	40	49	16,5	32	36	190	9,94	FI-GE-22LR-DF-W3		
	22	160	G 1	22,2	18	43	51	17,5	41	36	330	16,58	FI-GE-22LR1-DF-W3		
	28	160	G 1/2	11,1	14	39	48	17,5	41	41	140	13,58	FI-GE-28LR1/2-DF-W3		
	28	160	G 3/4	16,7	16	41	50	17,5	41	41	190	15,87	FI-GE-28LR3/4-DF-W3		
	28	160	G 1	22,2	18	43	52	17,5	41	41	330	17,46	FI-GE-28LR-DF-W3		
	28	160	G 1 1/4	28,6	20	48	57	20,5	50	41	540	20,04	FI-GE-28LR1-1/4-DF-W3		
	35	160	G 1	22,2	18	46	57	17,5	50	50	330	24,26	FI-GE-35LR1-DF-W3		
	35	125	G 1 1/4	28,6	20	48	59	17,5	50	50	540	28,81	FI-GE-35LR-DF-W3		
	42	125	G 1 1/4	28,6	20	50	62	19	55	60	540	33,91	FI-GE-42LR1-1/4-DF-W3		
	42	125	G 1 1/2	33,3	22	52	64	19	55	60	630	36,75	FI-GE-42LR-DF-W3		

Ordering Codes
***FI-GE*-10*L*R*-DF*-W3*-MS**

* Straight Male Stud Fitting		FI-GE
* Outside Tube Diameter D1 (in mm)		-10
* Series	Light Series (page 55) Heavy Series (page 56)	L S
* Thread Type	Whitworth Parallel Pipe Thread (BSPP)	R
If required, please indicate special sizes, e.g. R1/8!		
* Seal Type	60° Conical Bore (BS 5200) / Sealing Surface for Gasket (DIN 7603)	-DF
* Material Code	Steel, zinc/nickel-plated	-W3
Please contact STAUFF for alternative materials and surface finishings.		
* Assembling / Kitting	Fitting body only	—
	Fitting body supplied with cutting ring and union nut	-MS
	Fitting body supplied with soft-sealing cutting ring and union nut	-MSV

¹ Approx.imate dimension in assembled condition.

² Weight excluding cutting ring and union nut.

³ Standard scope of delivery: Fitting body only.

Male threaded studs were designed for female threaded ports in components made of steel. For applications with components made of softer mating materials (e.g. Aluminium), the use of connectors with additionally rolled male threads is recommended.

Please contact STAUFF prior to the assembly for further information.

Male stud acc. to DIN 3852-2 (Form A)
Port acc. to DIN 3852-2 (Form X) / ISO 1179-1

Torque recommendations for Steel mating material.

Connecting Parts

	Cutting Ring Type FI-DS	Page 28
	Soft-Sealing Cutting Ring Type FI-WDDS	Page 29
	Support Sleeve Type FI-VH	Page 31
	STAUFF Form EVO Sealing Ring Type FI-FD	Page 32
	Union Nut Type FI-M	Page 33
	37° Flared Tube Fitting Set Type FI-AB	Page 37



Straight Male Stud Fitting
Type FI-GE-...-R-DF • Series S

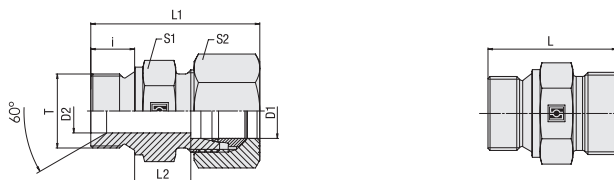

C

60° Conical Bore / Sealing Surface for Gaskets

Whitworth Parallel Pipe Thread (BSPP)

Ordering Codes

***FI-GE*-10*S*R*-DF*-W3*-MS**

- * Straight Male Stud Fitting FI-GE
- * Outside Tube Diameter D1 (in mm) -10
- * Series L
S
Light Series (page 55)
Heavy Series (page 56)
- * Thread Type R
Whitworth Parallel
Pipe Thread (BSPP)
- If required, please indicate special sizes, e.g. R1/8!
- * Seal Type -DF
60° Conical Bore (BS 5200) /
Sealing Surface for Gasket
(DIN 7603)
- * Material Code -W3
Steel, zinc/nickel-plated
- Please contact STAUFF for alternative
materials and surface finishings.
- * Assembling / Kitting —
Fitting body only
- Fitting body supplied with
cutting ring and union nut -MS
- Fitting body supplied with
soft-sealing cutting ring
and union nut -MSV

Series	Tube OD mm D1	PN bar	Dimensions mm										Torque N-m Thread T	Weight kg ca. per 100	Ordering Codes ³
			Thread	T	D2	i	L	L1 ¹	L2	S1	S2				
S	6	250	G 1/8	3,5	8	27,5	35	12,5	14	17	20	2,09	FI-GE-06SR1/8-DF-W3		
	6	250	G 1/4	4	12	32	40	13	19	17	60	3,48	FI-GE-06SR-DF-W3		
	6	250	G 3/8	7,9	12	34,5	42	15,5	22	17	100	4,63	FI-GE-06SR3/8-DF-W3		
	6	250	G 1/2	11,1	14	35	43	14	27	17	160	6,22	FI-GE-06SR1/2-DF-W3		
	8	250	G 1/8	3,5	8	27,5	35	12,5	14	17	20	2,71	FI-GE-08SR1/8-DF-W3		
	8	250	G 1/4	4,7	12	34	42	15	19	19	60	4,10	FI-GE-08SR-DF-W3		
	8	250	G 3/8	7,9	12	34,5	42	15,5	22	19	100	5,25	FI-GE-08SR3/8-DF-W3		
	8	250	G 1/2	11,1	14	39	47	18	27	19	160	8,47	FI-GE-08SR1/2-DF-W3		
	10	250	G 1/4	4,7	12	34	42	14,5	19	22	60	4,33	FI-GE-10SR1/4-DF-W3		
	10	250	G 3/8	7	12	34,5	43,5	15	22	22	100	5,46	FI-GE-10SR-DF-W3		
	10	160	G 1/2	11,1	14	35	43	13,5	27	22	160	6,76	FI-GE-10SR1/2-DF-W3		
	12	250	G 1/4	4,7	12	36	44	16,5	22	24	60	5,70	FI-GE-12SR1/4-DF-W3		
	12	250	G 3/8	7,9	12	36,5	45,5	17	22	24	100	6,17	FI-GE-12SR-DF-W3		
	12	160	G 1/2	11,1	14	39	48	17,5	27	24	160	8,75	FI-GE-12SR1/2-DF-W3		
	12	160	G 3/4	16,7	16	43	51	19,5	32	24	280	12,90	FI-GE-12SR3/4-DF-W3		
	14	160	G 1/2	10	14	41	51	19	27	27	160	9,56	FI-GE-14SR-DF-W3		
	16	250	G 3/8	7,9	12	38,5	48	18	27	30	100	6,82	FI-GE-16SR3/8-DF-W3		
	16	160	G 1/2	11,1	14	41	51	18,5	27	30	160	9,05	FI-GE-16SR-DF-W3		
	16	160	G 3/4	16,7	16	45	55	20,5	32	30	280	13,31	FI-GE-16SR3/4-DF-W3		
	20	160	G 1/2	11,1	14	45	54	20,5	32	36	160	13,74	FI-GE-20SR1/2-DF-W3		
	20	160	G 3/4	16	16	47	58	20,5	32	36	280	14,90	FI-GE-20SR-DF-W3		
	20	160	G 1	22,2	18	51	62	22,5	41	36	440	23,12	FI-GE-20SR1-DF-W3		
	25	160	G 1/2	11,1	14	49	56	23	41	46	160	23,68	FI-GE-25SR1/2-DF-W3		
	25	160	G 3/4	16,7	16	51	63	23	41	46	280	23,73	FI-GE-25SR3/4-DF-W3		
	25	160	G 1	20	18	53	65	23	41	46	440	20,71	FI-GE-25SR-DF-W3		
	30	160	G 3/4	16,7	16	53	66	23,5	50	50	280	33,85	FI-GE-30SR3/4-DF-W3		
	30	160	G 1	22,2	18	55	68	23,5	46	50	440	32,20	FI-GE-30SR1-DF-W3		
	30	125	G 1 1/4	25	20	57	70	23,5	50	50	580	40,27	FI-GE-30SR-DF-W3		
38	160	G 1	22,2	18	60	73	26	55	60	440	47,79	FI-GE-38SR1-DF-W3			
38	125	G 1 1/4	38,6	20	62	77	26	55	60	580	51,40	FI-GE-38SR1-1/4-DF-W3			
38	125	G 1 1/2	32	22	64	79	26	55	60	700	54,70	FI-GE-38SR-DF-W3			

Connecting Parts

- Cutting Ring
Type **FI-DS** Page 28
- Soft-Sealing Cutting Ring
Type **FI-WDDS** Page 29
- Support Sleeve
Type **FI-VH** Page 31
- STAUFF Form EVO Sealing Ring
Type **FI-FD** Page 32
- Union Nut
Type **FI-M** Page 33
- 37° Flared Tube Fitting Set
Type **FI-AB** Page 37

¹ Approx.imate dimension in assembled condition.
² Weight excluding cutting ring and union nut.
³ Standard scope of delivery: Fitting body only.

Male stud acc. to DIN 3852-2 (Form A)
Port acc. to DIN 3852-2 (Form X) / ISO 1179-1

Torque recommendations for Steel mating material.

Male threaded studs were designed for female threaded ports in components made of steel. For applications with components made of softer mating materials (e.g. Aluminium), the use of connectors with additionally rolled male threads is recommended.
Please contact STAUFF prior to the assembly for further information.



Straight Male Stud Fitting
Type FI-GE-...-M-OR • Series L

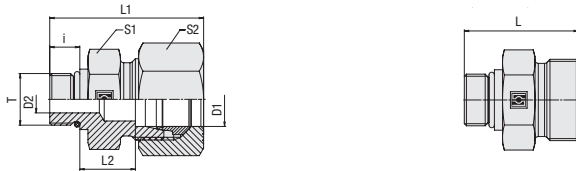

C

Metric Parallel Thread

O-Ring

Series	Tube OD mm	PN bar	Dimensions mm								Torque N-m	Weight kg ca. per 100	Ordering Codes ³
			Thread	T	D2	i	L	L1 ¹	L2	S1			
L	6	500	M 10 x 1	4	8,5	25	33	9,5	14	14	15	1,53	FI-GE-06LM-OR-B-W3
	8	500	M 10 x 1	3	8,5	25	32	9,5	14	17	15	1,66	FI-GE-08LM10x1-OR-B-W3
	8	500	M 12 x 1,5	6	11	28	36	10	17	17	25	2,16	FI-GE-08LM-OR-B-W3
	8	500	M 14 x 1,5	6	11	33	40	15	19	17	35	3,9	FI-GE-08LM14x1.5-OR-B-W3
	8	400	M 18 x 1,5	11	12,5	31	36	11,5	24	17	45	4,43	FI-GE-08LM18x1.5-OR-B-W3
	10	500	M 12 x 1,5	6	11	29	36	11	19	19	25	2,66	FI-GE-10LM12x1.5-OR-B-W3
	10	500	M 14 x 1,5	7,5	11	29	37	11	19	19	35	2,87	FI-GE-10LM-OR-B-W3
	10	400	M 18 x 1,5	8	12,5	32	39	12,5	24	19	45	5,23	FI-GE-10LM18x1.5-OR-B-W3
	12	400	M 12 x 1,5	6	11	30,5	38	12,5	19	22	25	2,89	FI-GE-12LM12x1.5-OR-B-W3
	12	400	M 14 x 1,5	7,5	11	31	39	13	19	22	35	3,45	FI-GE-12LM14x1.5-OR-B-W3
	12	400	M 16 x 1,5	9	11,5	31	39	12,5	22	22	40	4,10	FI-GE-12LM-OR-B-W3
	12	400	M 18 x 1,5	10	12,5	32	40	12,5	24	22	45	5,14	FI-GE-12LM18x1.5-OR-B-W3
	15	400	M 18 x 1,5	11	12,5	33	41	13,5	24	27	45	5,32	FI-GE-15LM-OR-B-W3
	18	400	M 22 x 1,5	14	13	35	44	14,5	27	32	60	7,55	FI-GE-18LM-OR-B-W3
	22	400	M 22 x 1,5	14	13	37	46	16,5	32	36	60	9,22	FI-GE-22LM22x1.5-OR-B-W3
	22	250	M 27 x 2	18	16	40	49	16,5	32	36	100	10,79	FI-GE-22LM27x2-OR-B-W3
	22	250	M 33 x 2	14	16	41	46	16,5	41	36	160	16,14	FI-GE-22LM33x2-OR-B-W3
	28	250	M 27 x 2	18	16	40,5	52	17	41	41	100	14,47	FI-GE-28LM27x2-OR-B-W3
	28	250	M 33 x 2	23	16	41	50	17,5	41	41	160	16,73	FI-GE-28LM-OR-B-W3
	35	250	M 42 x 2	30	16	44	55	17,5	50	50	210	26,66	FI-GE-35LM-OR-B-W3
	42	250	M 48 x 2	36	17,5	47,5	59,5	19	55	60	260	33,79	FI-GE-42LM-OR-B-W3

¹ Approx.imate dimension in assembled condition.

² Weight excluding cutting ring and union nut.

³ Standard scope of delivery: Fitting body only.

Male stud acc. to ISO 6149-2/-3

Port acc. to ISO 6149-1

Torque recommendations for Steel mating material.

Standard seal material is NBR (Buna-N®).

Male threaded studs were designed for female threaded ports in components made of steel. For applications with components made of softer mating materials (e.g. Aluminium), the use of connectors with additionally rolled male threads is recommended.

Please contact STAUFF prior to the assembly for further information.

Ordering Codes

***FI-GE*-10*L*M*-OR*-B*-W3*-MS**

* Straight Male Stud Fitting		FI-GE
* Outside Tube Diameter D1 (in mm)		-10
* Series	Light Series (page 57)	L
	Heavy Series (page 58)	S
* Thread Type	Metric Parallel Thread	M
If required, please indicate special sizes, e.g. M12x1.5!		
* Seal Type	O-Ring	-OR
* Seal Material	NBR (Buna-N®)	-B
	FKM (Viton®)	-V
* Material Code	Steel, zinc/nickel-plated	-W3

Please contact STAUFF for alternative materials and surface finishings.

* Assembling / Kitting	Fitting body only	—
	Fitting body supplied with cutting ring and union nut	-MS
	Fitting body supplied with soft-sealing cutting ring and union nut	-MSV

Connecting Parts

	Cutting Ring Type FI-DS	Page 28
	Soft-Sealing Cutting Ring Type FI-WDDS	Page 29
	Support Sleeve Type FI-VH	Page 31
	STAUFF Form EVO Sealing Ring Type FI-FD	Page 32
	Union Nut Type FI-M	Page 33
	37° Flared Tube Fitting Set Type FI-AB	Page 37

Spare Parts / Accessories

	O-Ring Type O-RING	Page 239
--	------------------------------	----------



Straight Male Stud Fitting
Type FI-GE-...-M-OR • Series S

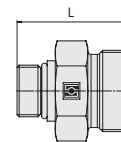
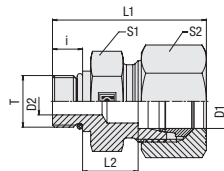

C

Metric Parallel Thread

O-Ring

Ordering Codes

***FI-GE*-10*S*M*-OR*-B*-W3*-MS**

- * Straight Male Stud Fitting **FI-GE**
- * Outside Tube Diameter D1 (in mm) **-10**
- * Series **L**
Light Series (page 57)
S
Heavy Series (page 58)
- * Thread Type **M**
Metric Parallel Thread
- If required, please indicate special sizes, e.g. M12x1.5!
- * Seal Type **-OR**
O-Ring
- * Seal Material **-B**
NBR (Buna-N®)
-V
FKM (Viton®)
- * Material Code **-W3**
Steel, zinc/nickel-plated
- Please contact STAUFF for alternative materials and surface finishings.
- * Assembling / Kitting **-MS**
Fitting body only
Fitting body supplied with cutting ring and union nut
-MSV
Fitting body supplied with soft-sealing cutting ring and union nut

Series	Tube OD mm D1	PN bar	Dimensions mm										Torque N-m Thread T	Weight kg ca. per 100	Ordering Codes ³
			Thread T	D2	i	L	L1 ¹	L2	S1	S2					
S	6	800	M 12 x 1,5	4	11	31	39	13	17	17	35	2,93	FI-GE-06SM-OR-B-W3		
	8	800	M 14 x 1,5	5	11	33	41	15	19	19	40	4,22	FI-GE-08SM-OR-B-W3		
	10	800	M 16 x 1,5	7	12,5	35	44	15	22	22	55	6,11	FI-GE-10SM-OR-B-W3		
	12	630	M 14 x 1,5	6	11	35,5	44	17	24	19	40	6	FI-GE-12SM14x1.5-OR-B-W3		
	12	630	M 18 x 1,5	8	14	38,5	47,5	17	24	24	70	3,41	FI-GE-12SM-OR-B-W3		
	16	630	M 22 x 1,5	12	15	42	52	18,5	27	30	100	6,37	FI-GE-16SM-OR-B-W3		
	20	420	M 27 x 2	15	18,5	49,5	60,5	20,5	32	36	170	16,88	FI-GE-20SM-OR-B-W3		
	25	420	M 33 x 2	20	18,5	53,5	65,5	23	41	46	310	27,42	FI-GE-25SM-OR-B-W3		
	30	420	M 42 x 2	25	19	56	69	23,5	50	50	330	42,45	FI-GE-30SM-OR-B-W3		
	38	420	M 48 x 2	32	21,5	63,5	78,5	26	55	60	420	58,60	FI-GE-38SM-OR-B-W3		

¹ Approx.imate dimension in assembled condition.

² Weight excluding cutting ring and union nut.

³ Standard scope of delivery: Fitting body only.

Male stud acc. to ISO 6149-2/-3

Port acc. to ISO 6149-1

Torque recommendations for Steel mating material.

Standard seal material is NBR (Buna-N®).

Male threaded studs were designed for female threaded ports in components made of steel. For applications with components made of softer mating materials (e.g. Aluminium), the use of connectors with additionally rolled male threads is recommended.

Please contact STAUFF prior to the assembly for further information.

Connecting Parts

-  Cutting Ring
Type **FI-DS** Page 28
-  Soft-Sealing Cutting Ring
Type **FI-WDDS** Page 29
-  Support Sleeve
Type **FI-VH** Page 31
-  STAUFF Form EVO Sealing Ring
Type **FI-FD** Page 32
-  Union Nut
Type **FI-M** Page 33
-  37° Flared Tube Fitting Set
Type **FI-AB** Page 37

Spare Parts / Accessories

-  O-Ring
Type **O-RING** Page 239



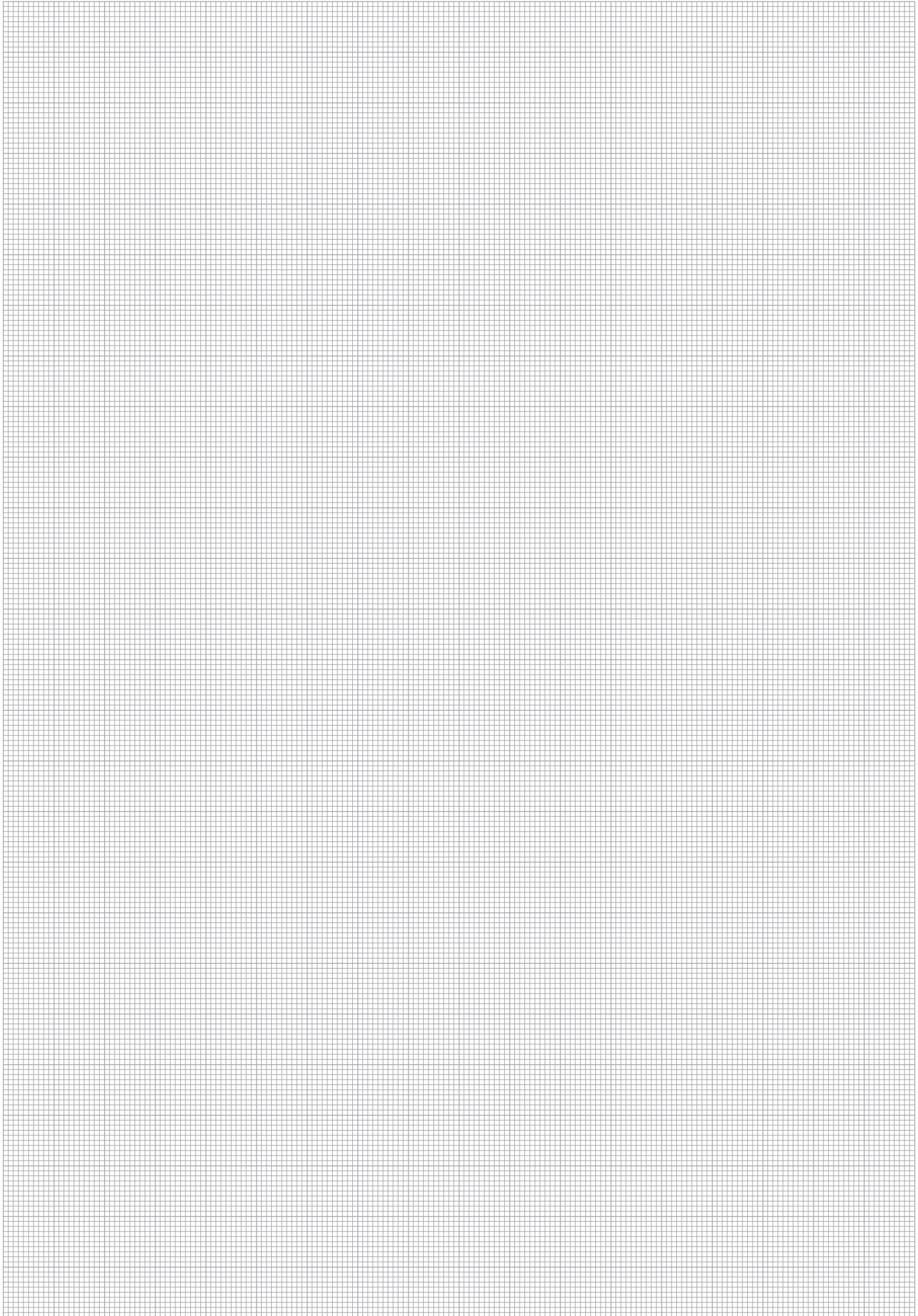

Straight Male Stud Fitting
Type FI-GE-...-Rk • Series LL

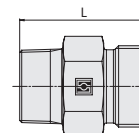
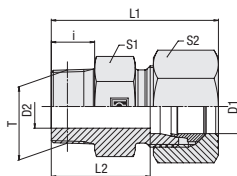

C

Whitworth Taper Pipe Thread (BSPT)

Ordering Codes

***FI-GE*-10*LL*Rk*-W3*-MS**

- * Straight Male Stud Fitting **FI-GE**
- * Outside Tube Diameter D1 (in mm) **-10**
- * Series **LL**
 Extra-Light Series (page 60)
 Light Series (page 61)
 Heavy Series (page 62)
L
S
- * Thread Type **Rk**
 Whitworth Taper
 Pipe Thread (BSPT)
- If required, please indicate special sizes, e.g. R1/8k!
- * Material Code **-W3**
 Steel, zinc/nickel-plated
- Please contact STAUFF for alternative materials and surface finishings.
- * Assembling / Kitting **—**
 Fitting body only
- Fitting body supplied with cutting ring and union nut **-MS**
- Fitting body supplied with soft-sealing cutting ring and union nut **-MSV**

Series	Tube OD mm D1	PN bar	Dimensions mm								Weight kg ca. per 100	Ordering Codes ³
			Thread	T	D2	i	L	L1 ¹	L2	S1		
LL	4	100	R 1/8 keg.	3	8	20	26	16	10	10	0,77	FI-GE-04LLRk-W3
	6	100	R 1/8 keg.	4,5	8	20	26	14,5	11	12	0,79	FI-GE-06LLRk-W3
	6	100	R 1/4 keg.	4,5	12	26	33	20,5	14	12	1,85	FI-GE-06LLR1/4k-W3
	8	100	R 1/8 keg.	4,5	8	22	28	16,5	12	14	1,08	FI-GE-08LLRk-W3
	8	100	R 1/4 keg.	6	12	26	32	20,5	14	14	1,71	FI-GE-08LLR1/4k-W3
	10	100	R 1/4 keg.	8	12	26	32	20,5	14	17	2,70	FI-GE-10LLRk-W3
	12	100	R 3/8 keg.	10	12	26	32,5	20	19	19	2,44	FI-GE-12LLR3/8k-W3

¹ Approximate dimension in assembled condition.

² Weight excluding cutting ring and union nut.

³ Standard scope of delivery: Fitting body only.

Male stud acc. to DIN 3852-2 (Form C)

Port acc. to DIN 3852-2 (Form Z)

Suitable liquid / plastic sealant required.

Male threaded studs were designed for female threaded ports in components made of steel. For applications with components made of softer mating materials (e.g. Aluminium), the use of connectors with additionally rolled male threads is recommended.

Please contact STAUFF prior to the assembly for further information.

Connecting Parts

- Cutting Ring
Type **FI-DS** Page 28
- Soft-Sealing Cutting Ring
Type **FI-WDDS** Page 29
- Support Sleeve
Type **FI-VH** Page 31
- STAUFF Form EVO Sealing Ring
Type **FI-FD** Page 32
- Union Nut
Type **FI-M** Page 33
- 37° Flared Tube Fitting Set
Type **FI-AB** Page 37



Straight Male Stud Fitting
Type FI-GE-...-Rk ▪ Series L

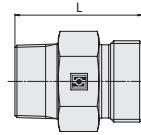
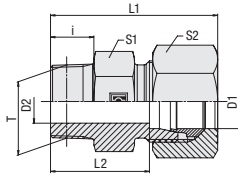

C

Whitworth Taper Pipe Thread (BSPT)

Series	Tube OD mm	PN bar	Dimensions mm	Dimensions								Weight kg ca. per 100	Ordering Codes ³
L	D1		Thread T	D2	i	L	L1 ¹	L2	S1	S2			
6	315	R 1/8 keg.	4	8	22	30	15	12	14	1,11	FI-GE-06LRk-W3		
6	315	R 1/4 keg.	4	12	27	35	20	14	14	1,99	FI-GE-06LR1/4k-W3		
6	315	R 3/8 keg.	4	12	28	36	21	19	14	2,80	FI-GE-06LR3/8k-W3		
6	315	R 1/2 keg.	4	14	30	38	23	22	14	5,19	FI-GE-06LR1/2k-W3		
8	315	R 1/8 keg.	4	8	25	33	18	14	17	1,78	FI-GE-08LR1/8k-W3		
8	315	R 1/4 keg.	6	12	27	35	20	14	17	1,88	FI-GE-08LRk-W3		
8	315	R 3/8 keg.	6	12	28	36	21	19	17	3,44	FI-GE-08LR3/8k-W3		
8	315	R 1/2 keg.	6	14	30	38	23	24	17	5,02	FI-GE-08LR1/2k-W3		
10	315	R 1/8 keg.	4	8	24	32	17	17	19	1,97	FI-GE-10LR1/8k-W3		
10	315	R 1/4 keg.	7	12	28	36	21	17	19	2,28	FI-GE-10LRk-W3		
10	315	R 3/8 keg.	8	12	29	37	22	19	19	3,13	FI-GE-10LR3/8k-W3		
10	315	R 1/2 keg.	8	14	30	38	23	24	19	1,22	FI-GE-10LR1/2k-W3		
12	315	R 1/4 keg.	6	12	29	37	22	19	22	3,03	FI-GE-12LR1/4k-W3		
12	315	R 3/8 keg.	9	12	29	37	22	19	22	3,28	FI-GE-12LRk-W3		
12	315	R 1/2 keg.	10	14	31	39	24	22	22	5,02	FI-GE-12LR1/2k-W3		
15	315	R 3/8 keg.	9	12	30	38	23	24	27	5,06	FI-GE-15LR3/8k-W3		
15	315	R 1/2 keg.	12	14	32	40	25	24	27	5,35	FI-GE-15LRk-W3		
15	160	R 3/4 keg.	12	17	36	44	29	27	27	16,48	FI-GE-15LR3/4k-W3		
18	315	R 1/2 keg.	14	14	33	42	25,5	27	32	6,42	FI-GE-18LRk-W3		
18	315	R 3/8 keg.	9	12	31	40	23,5	27	32	6,4	FI-GE-18LR3/8k-W3		
18	160	R 3/4 keg.	15	17	36	47	28,5	32	32	10,47	FI-GE-18LR3/4k-W3		
22	160	R 1/2 keg.	12	14	38	47	30,5	32	36	10,20	FI-GE-22LR1/2k-W3		
22	160	R 3/4 keg.	17	17	37	46	29,5	32	36	8,91	FI-GE-22LRk-W3		
22	160	R 1 keg.	19	18	41	51	33,5	36	36	15,89	FI-GE-22LR1k-W3		
28	160	R 3/4 keg.	18	16	38	47	31,5	41	41	14,59	FI-GE-28LR3/4k-W3		
28	160	R 1 keg.	23	18	40	51	34,5	41	41	16,49	FI-GE-28LRk-W3		
35	160	R 1 keg.	23	20	45	56	34,5	46	50	23,76	FI-GE-35LR1k-W3		
35	160	R 1 1/4 keg.	30	20	45	56	34,5	46	50	23,73	FI-GE-35LRk-W3		
42	160	R 1 1/2 keg.	36	22	49	61	38	55	60	33,09	FI-GE-42LRk-W3		

Ordering Codes

***FI-GE*-10*L*Rk*-W3*-MS**

- * Straight Male Stud Fitting **FI-GE**
- * Outside Tube Diameter D1 (in mm) **-10**
- * Series
Extra-Light Series (page 60) **LL**
Light Series (page 61) **L**
Heavy Series (page 62) **S**
- * Thread Type
Whitworth Taper Pipe Thread (BSPT) **Rk**

If required, please indicate special sizes, e.g. R1/8k!

- * Material Code
Steel, zinc/nickel-plated **-W3**

Please contact STAUFF for alternative materials and surface finishings.

- * Assembling / Kitting
Fitting body only **-**
Fitting body supplied with cutting ring and union nut **-MS**
Fitting body supplied with soft-sealing cutting ring and union nut **-MSV**

Connecting Parts

- Cutting Ring
Type **FI-DS** Page 28
- Soft-Sealing Cutting Ring
Type **FI-WDDS** Page 29
- Support Sleeve
Type **FI-VH** Page 31
- STAUFF Form EVO Sealing Ring
Type **FI-FD** Page 32
- Union Nut
Type **FI-M** Page 33
- 37° Flared Tube Fitting Set
Type **FI-AB** Page 37

¹ Approx.imate dimension in assembled condition.
² Weight excluding cutting ring and union nut.
³ Standard scope of delivery: Fitting body only.

Male stud acc. to DIN 3852-2 (Form C)
Port acc. to DIN 3852-2 (Form Z)
Suitable liquid / plastic sealant required.

Male threaded studs were designed for female threaded ports in components made of steel. For applications with components made of softer mating materials (e.g. Aluminium), the use of connectors with additionally rolled male threads is recommended.
Please contact STAUFF prior to the assembly for further information.



Straight Male Stud Fitting
Type FI-GE-...-Rk • Series S

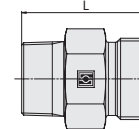
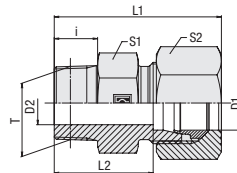

Whitworth Taper Pipe Thread (BSPT)

Ordering Codes

***FI-GE*-10*S*Rk*-W3*-MS**

- * Straight Male Stud Fitting **FI-GE**
- * Outside Tube Diameter D1 (in mm) **-10**
- * Series **LL**
 Extra-Light Series (page 60)
L
 Light Series (page 61)
S
 Heavy Series (page 62)
- * Thread Type **Rk**
 Whitworth Taper
 Pipe Thread (BSPT)
- If required, please indicate special sizes, e.g. R1/8k!
- * Material Code **-W3**
 Steel, zinc/nickel-plated
- Please contact STAUFF for alternative materials and surface finishings.
- * Assembling / Kitting **—**
 Fitting body only
- Fitting body supplied with cutting ring and union nut **-MS**
- Fitting body supplied with soft-sealing cutting ring and union nut **-MSV**

Series	Tube OD mm D1	PB bar	Dimensions mm								Weight kg ca. per 100	Ordering Codes ³
			Thread	T	D2	i	L	L1 ¹	L2	S1		
S	6	630	R 1/4 keg.	4	12	30	38	23	17	17	3,01	FI-GE-06SRk-W3
	8	630	R 1/4 keg.	5	12	29	37	22	17	19	3,50	FI-GE-08SRk-W3
	10	630	R 3/8 keg.	7	12	32	41	24,5	19	22	4,49	FI-GE-10SRk-W3
	12	630	R 3/8 keg.	8	12	34	43	26,5	22	24	6,03	FI-GE-12SRk-W3
	14	630	R 3/8 keg.	8	12	34,5	45	26,5	24	27	6,56	FI-GE-14SR3/8k-W3
	14	630	R 1/2 keg.	10	14	35	45	27	24	27	7,04	FI-GE-14SRk-W3
	16	400	R 3/8 keg.	9	12	32	47	23,5	27	30	6,13	FI-GE-16SR3/8k-W3
	16	400	R 1/2 keg.	12	14	38	48	29,5	27	30	8,52	FI-GE-16SRk-W3
	20	400	R 3/4 keg.	16	17	45,5	57	35	32	36	14,43	FI-GE-20SRk-W3
	25	400	R 3/4 keg.	16	17	48	62,5	37	41	46	10,15	FI-GE-25SR3/4k-W3
	25	400	R 1 keg.	20	18	49	63,5	37	41	46	25,81	FI-GE-25SRk-W3
	30	400	R 1 keg.	20	18	52	67,5	39	50	50	31,78	FI-GE-30SR1k-W3
30	250	R 1-1/4 keg.	25	20	54	69,5	41	50	50	36,69	FI-GE-30SRk-W3	
38	250	R 1 1/2 keg.	32	22	59	75	43	55	60	50,8	FI-GE-38SRk-W3	

¹ Approximate dimension in assembled condition.

² Weight excluding cutting ring and union nut.

³ Standard scope of delivery: Fitting body only.

Male stud acc. to DIN 3852-2 (Form C)

Port acc. to DIN 3852-2 (Form Z)

Suitable liquid / plastic sealant required.

Male threaded studs were designed for female threaded ports in components made of steel. For applications with components made of softer mating materials (e.g. Aluminium), the use of connectors with additionally rolled male threads is recommended.

Please contact STAUFF prior to the assembly for further information.

Connecting Parts

-  Cutting Ring
Type **FI-DS** Page 28
-  Soft-Sealing Cutting Ring
Type **FI-WDDS** Page 29
-  Support Sleeve
Type **FI-VH** Page 31
-  STAUFF Form EVO Sealing Ring
Type **FI-FD** Page 32
-  Union Nut
Type **FI-M** Page 33
-  37° Flared Tube Fitting Set
Type **FI-AB** Page 37



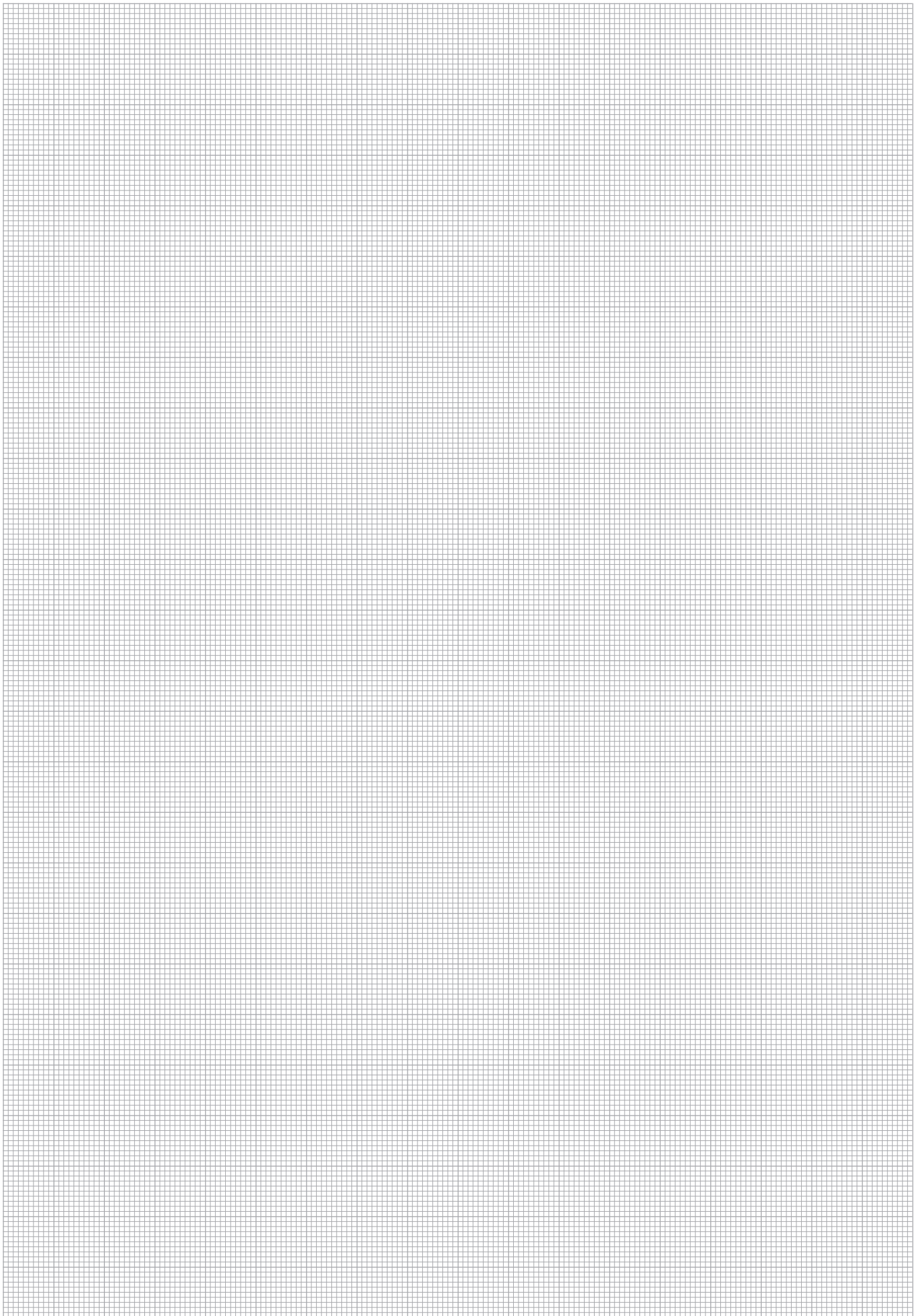

Straight Male Stud Fitting
Type FI-GE*...-Mk ▪ Series LL / L

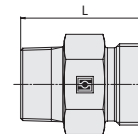
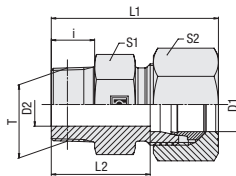

C

Metric Taper Thread

Ordering Codes

***FI-GE*-10*L*Mk*-W3*-MS**

- * Straight Male Stud Fitting **FI-GE**
- * Outside Tube Diameter D1 (in mm) **-10**
- * Series **LL**
Extra-Light Series
Light Series **L**
- * Thread Type **Mk**
Metric Taper Thread
- If required, please indicate special sizes, e.g. M16x1.5k!
- * Material Code **-W3**
Steel, zinc/nickel-plated
- Please contact STAUFF for alternative materials and surface finishings.
- * Assembling / Kitting **—**
Fitting body only
- Fitting body supplied with cutting ring and union nut **-MS**
- Fitting body supplied with soft-sealing cutting ring and union nut **-MSV**

Series	Tube OD mm D1	PN bar	Dimensions mm										Weight kg ca. per 100	Ordering Codes ³
			Thread	T	D2	i	L	L1 ¹	L2	S1	S2			
LL	4	100	M 6 x 1 keg.	2,5	8	20	26	16	9	10	0,50	FI-GE-04LLM6x1k-W3		
	4	100	M 8 x 1 keg.	3	8	20	26	16	10	10	0,63	FI-GE-04LLMk-W3		
	4	100	M 10 x 1 keg.	3	8	20	26	16	11	10	0,85	FI-GE-04LLM10x1k-W3		
	6	100	M 6 x 1 keg.	2	8	20	26	14,5	11	12	0,68	FI-GE-06LLM6x1k-W3		
	6	100	M 8 x 1 keg.	3	8	20	26	14,5	11	12	0,75	FI-GE-06LLM8x1k-W3		
	6	100	M 10 x 1 keg.	4	8	20	26	14,5	11	12	0,85	FI-GE-06LLMk-W3		
	8	100	M 8 x 1 keg.	3,5	8	22	28	16,5	12	14	1,29	FI-GE-08LLM8x1k-W3		
	8	100	M 10 x 1 keg.	6	8	22	28	16,5	12	14	0,98	FI-GE-08LLMk-W3		
L	6	315	M 10 x 1 keg.	4	8	23	31	16	14	14	1,44	FI-GE-06LMk-W3		
	6	315	M 12 x 1,5 keg.	4	12	27	35	20	14	14	1,56	FI-GE-06LM12x1.5k-W3		
	8	315	M 12 x 1,5 keg.	6	12	27	35	20	14	17	1,74	FI-GE-08LMk-W3		
	8	315	M 14 x 1,5 keg.	6	12	27	35	20	17	17	3,11	FI-GE-08LM14x1.5k-W3		
	10	315	M 14 x 1,5 keg.	7	12	28	36	21	17	19	2,51	FI-GE-10LMk-W3		
	10	315	M 16 x 1,5 keg.	8	12	28	36	21	17	19	4,05	FI-GE-10LM16x1.5k-W3		
	12	315	M 16 x 1,5 keg.	9	12	29	37	22	19	22	3,18	FI-GE-12LMk-W3		
	12	315	M 18 x 1,5 keg.	10	12	29	37	22	19	22	4,90	FI-GE-12LM18x1.5k-W3		
	15	315	M 18 x 1,5 keg.	11	12	30	41	23	24	27	4,73	FI-GE-15LMk-W3		
	18	315	M 22 x 1,5 keg.	14	14	33	42	25,5	27	32	7,02	FI-GE-18LMk-W3		

¹ Approximate dimension in assembled condition.

² Weight excluding cutting ring and union nut.

³ Standard scope of delivery: Fitting body only.

Male stud acc. to DIN 3852-1 (Form C)

Port acc. to DIN 3852-1 (Form Z)

Suitable liquid / plastic sealant required.

Connecting Parts

- Cutting Ring
Type **FI-DS** Page 28
- Soft-Sealing Cutting Ring
Type **FI-WDDS** Page 29
- Support Sleeve
Type **FI-VH** Page 31
- STAUFF Form EVO Sealing Ring
Type **FI-FD** Page 32
- Union Nut
Type **FI-M** Page 33
- 37° Flared Tube Fitting Set
Type **FI-AB** Page 37

Male threaded studs were designed for female threaded ports in components made of steel. For applications with components made of softer mating materials (e.g. Aluminium), the use of connectors with additionally rolled male threads is recommended.

Please contact STAUFF prior to the assembly for further information.



Straight Male Stud Fitting
Type FI-GE-...-N • Series LL / L

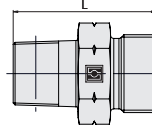
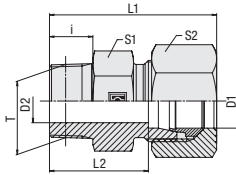

C

NPT Thread

Series	Tube OD mm	PN bar	Dimensions mm									Weight kg ca. per 100	Ordering Codes ³
			Thread	T	D2	i	L	L1 ¹	L2	S1	S2		
LL	4	100	1/8 NPT	3	10	22	28	18	11	10	0,98	FI-GE-04LL1/8N-W3	
	6	100	1/8 NPT	4,5	10	22	28	16,5	11	12	0,90	FI-GE-06LL1/8N-W3	
	8	100	1/8 NPT	5	10	24	30	18,5	12	14	1,16	FI-GE-08LL1/8N-W3	
L	6	315	1/8 NPT	4	10	24	32	17	12	14	1,21	FI-GE-06L1/8N-W3	
	6	315	1/4 NPT	4	15,5	30	38	23	17	14	2,63	FI-GE-06L1/4N-W3	
	6	315	3/8 NPT	4	15,5	31	39	24	19	14	4,01	FI-GE-06L3/8N-W3	
	6	315	1/2 NPT	4	20	36	44	29	22	14	5,62	FI-GE-06L1/2N-W3	
	8	315	1/8 NPT	4	10	25	33	18	14	17	1,65	FI-GE-08L1/8N-W3	
	8	315	1/4 NPT	6	15	30	38	23	17	17	2,49	FI-GE-08L1/4N-W3	
	8	315	3/8 NPT	6	15,5	30	38	23	19	17	3,70	FI-GE-08L3/8N-W3	
	8	315	1/2 NPT	6	20	36	44	29	22	17	6,78	FI-GE-08L1/2N-W3	
	10	315	1/8 NPT	4	10	25	33	18	17	19	1,90	FI-GE-10L1/8N-W3	
	10	315	1/4 NPT	7	15	31	39	24	17	19	2,53	FI-GE-10L1/4N-W3	
	10	315	3/8 NPT	7	15	32	40	25	19	19	3,97	FI-GE-10L3/8N-W3	
	10	315	1/2 NPT	7	20	37	45	30	22	19	6,99	FI-GE-10L1/2N-W3	
	10	315	3/4 NPT	8	20	38	46	31	27	19	5,67	FI-GE-10L3/4N-W3	
	12	315	1/8 NPT	4	10	26	34	19	19	22	2,48	FI-GE-12L1/8N-W3	
	12	315	1/4 NPT	7	15	32	40	25	19	22	3,21	FI-GE-12L1/4N-W3	
	12	315	3/8 NPT	8	15	32	40	25	19	22	3,95	FI-GE-12L3/8N-W3	
	12	315	1/2 NPT	10	20	37	45	30	24	22	6,48	FI-GE-12L1/2N-W3	
	12	315	3/4 NPT	8	20	38	46	31	27	22	10,93	FI-GE-12L3/4N-W3	
15	315	1/4 NPT	7	15	33	41	26	24	27	4,72	FI-GE-15L1/4N-W3		
15	315	3/8 NPT	11	15,5	38	41	31	24	27	5,12	FI-GE-15L3/8N-W3		
15	315	1/2 NPT	12	20	38	46	31	24	27	6,44	FI-GE-15L1/2N-W3		
15	315	3/4 NPT	12	20	40	48	33	27	27	10,60	FI-GE-15L3/4N-W3		

Ordering Codes

FI-GE-10*L*1/4*N*-W3*-MS

* Straight Male Stud Fitting	FI-GE
* Outside Tube Diameter D1 (in mm)	-10
* Series	Extra-Light Series (page 65) LL Light Series (pages 65/66) L Heavy Series (pages 67/68) S
* Thread Size	acc. to dimension table 1/4
Please always indicate thread sizes, e.g. 1/4!	
* Thread Type	NPT Thread N
* Material Code	Steel, zinc/nickel-plated -W3
Please contact STAUFF for alternative materials and surface finishings.	
* Assembling / Kitting	Fitting body only —
	Fitting body supplied with cutting ring and union nut -MS
	Fitting body supplied with soft-sealing cutting ring and union nut -MSV

¹ Approx.imate dimension in assembled condition.
² Weight excluding cutting ring and union nut.
³ Standard scope of delivery: Fitting body only.

Male stud acc. to ANSI/ASME B1.20.1-1983
Port acc. to ANSI/ASME B1.20.1-1983

Suitable liquid / plastic sealant required.

Male threaded studs were designed for female threaded ports in components made of steel. For applications with components made of softer mating materials (e.g. Aluminium), the use of connectors with additionally rolled male threads is recommended.
Please contact STAUFF prior to the assembly for further information.

Connecting Parts

	Cutting Ring Type FI-DS	Page 28
	Soft-Sealing Cutting Ring Type FI-WDDS	Page 29
	Support Sleeve Type FI-VH	Page 31
	STAUFF Form EVO Sealing Ring Type FI-FD	Page 32
	Union Nut Type FI-M	Page 33
	37° Flared Tube Fitting Set Type FI-AB	Page 37



Straight Male Stud Fitting
Type FI-GE-...-N ▪ Series L

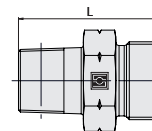
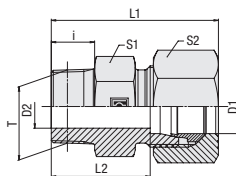

C

Ordering Codes

***FI-GE*-10*L*1/4*N*-W3*-MS**

- * Straight Male Stud Fitting **FI-GE**
- * Outside Tube Diameter D1 (in mm) **-10**
- * Series **LL**
 Extra-Light Series (page 65)
 Light Series (pages 65/66) **L**
 Heavy Series (pages 67/68) **S**
- * Thread Size **1/4**
 acc. to dimension table
 Please always indicate thread sizes, e.g. 1/4!
- * Thread Type **N**
 NPT Thread
- * Material Code **-W3**
 Steel, zinc/nickel-plated
 Please contact STAUFF for alternative materials and surface finishings.
- * Assembling / Kitting **—**
 Fitting body only
 Fitting body supplied with cutting ring and union nut **-MS**
 Fitting body supplied with soft-sealing cutting ring and union nut **-MSV**

NPT Thread

Series	Tube OD mm D1	PN bar	Dimensions mm										Weight kg ca. per 100	Ordering Codes ³
			Thread	T	D2	i	L	L1 ¹	L2	S1	S2			
L	18	315	3/8 NPT	8	15,5	34	43	26,5	27	32	6,78	FI-GE-18L3/8N-W3		
	18	315	1/2 NPT	12	20	39	48	31,5	27	32	8,10	FI-GE-18L1/2N-W3		
	18	315	3/4 NPT	15	20	39	48	31,5	27	32	10,51	FI-GE-18L3/4N-W3		
	18	315	1 NPT	15	25	45	54	37,5	36	32	16,85	FI-GE-18L1N-W3		
	22	160	1/2 NPT	14	20	41	50	33,5	32	36	9,26	FI-GE-22L1/2N-W3		
	22	160	3/4 NPT	16	20	41	50	33,5	32	36	11,07	FI-GE-22L3/4N-W3		
	22	160	1 NPT	19	25	47	56	39,5	36	36	18,05	FI-GE-22L1N-W3		
	28	160	3/4 NPT	18	20	42	51	34,5	41	41	18,00	FI-GE-28L3/4N-W3		
	28	160	1 NPT	21	25	47	56	39,5	41	41	19,89	FI-GE-28L1N-W3		
	28	160	1 1/4 NPT	24	26	49	58	41,5	46	41	27,00	FI-GE-28L1-1/4N-W3		
	35	160	1 NPT	21	21	46	57	40,5	46	50	24,03	FI-GE-35L1N-W3		
	35	160	1 1/4 NPT	28	26	51	62	40,5	46	50	39,59	FI-GE-35L1-1/4N-W3		
	42	160	1 1/4 NPT	28	26	53	65	42	55	60	35,36	FI-GE-42L1-1/4N-W3		
	42	160	1 1/2 NPT	36	26	53	65	42	55	60	35,36	FI-GE-42L1-1/2N-W3		

¹ Approximate dimension in assembled condition.

² Weight excluding cutting ring and union nut.

³ Standard scope of delivery: Fitting body only.

Male stud acc. to ANSI/ASME B1.20.1-1983

Port acc. to ANSI/ASME B1.20.1-1983

Suitable liquid / plastic sealant required.

Male threaded studs were designed for female threaded ports in components made of steel. For applications with components made of softer mating materials (e.g. Aluminium), the use of connectors with additionally rolled male threads is recommended.

Please contact STAUFF prior to the assembly for further information.

Connecting Parts

-  Cutting Ring
Type **FI-DS** Page 28
-  Soft-Sealing Cutting Ring
Type **FI-WDDS** Page 29
-  Support Sleeve
Type **FI-VH** Page 31
-  STAUFF Form EVO Sealing Ring
Type **FI-FD** Page 32
-  Union Nut
Type **FI-M** Page 33
-  37° Flared Tube Fitting Set
Type **FI-AB** Page 37



Straight Male Stud Fitting
Type FI-GE-...-N ▪ Series S

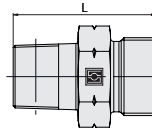
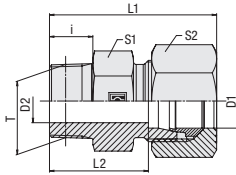

C

NPT Thread

Series	Tube OD mm	PN bar	Dimensions mm									Weight kg ca. per 100	Ordering Codes ³
			Thread	T	D2	i	L	L1 ¹	L2	S1	S2		
S	6	630	1/8 NPT	4	10	28	36	21	14	17	2,30	FI-GE-06S1/8N-W3	
	6	630	1/4 NPT	4	15	35	43	28	17	17	3,71	FI-GE-06S1/4N-W3	
	6	630	3/8 NPT	4	15,5	33	41	26	19	17	4,50	FI-GE-06S3/8N-W3	
	6	630	1/2 NPT	12	20	38	45	30,5	22	17	8,8	FI-GE-06S1/2N-W3	
	8	630	1/8 NPT	4	10	29,5	37,5	22,5	17	19	3,20	FI-GE-08S1/8N-W3	
	8	630	1/4 NPT	5	15	35	43	28	17	19	3,81	FI-GE-08S1/4N-W3	
	8	630	3/8 NPT	5	15,5	36	44	29	19	19	5,31	FI-GE-08S3/8N-W3	
	8	630	1/2 NPT	5	20	40	48	33	22	19	8,17	FI-GE-08S1/2N-W3	
	10	630	1/4 NPT	5	15	35	44	27,5	19	22	4,36	FI-GE-10S1/4N-W3	
	10	630	3/8 NPT	7	15	35	44	27,5	19	22	4,95	FI-GE-10S3/8N-W3	
	10	630	1/2 NPT	7	20	38	47	30,5	22	22	7,32	FI-GE-10S1/2N-W3	
	12	630	1/4 NPT	5	15	37	46	29,5	22	24	4,84	FI-GE-12S1/4N-W3	
	12	630	3/8 NPT	8	15	37	46	29,5	22	24	6,21	FI-GE-12S3/8N-W3	
	12	630	1/2 NPT	8	20	42	51	34,5	22	24	8,52	FI-GE-12S1/2N-W3	
	12	630	3/4 NPT	8	20	44	53	36,5	30	24	12,38	FI-GE-12S3/4N-W3	
	14	630	3/8 NPT	8	15,5	39	49	31	24	27	7,32	FI-GE-14S3/8N-W3	
	14	630	1/2 NPT	10	20	44	54	36	24	27	6,76	FI-GE-14S1/2N-W3	
	14	630	3/4 NPT	16	20	46	56	38	32	27	15,36	FI-GE-14S3/4N-W3	
	16	400	3/8 NPT	8	15	39	49	30,5	27	30	8,66	FI-GE-16S3/8N-W3	
	16	400	1/2 NPT	12	20	44	54	35,5	27	30	4,42	FI-GE-16S1/2N-W3	
16	400	3/4 NPT	12	20	45	55	36,5	30	30	13,97	FI-GE-16S3/4N-W3		

Ordering Codes

FI-GE-10*S*1/4*N*-W3*-MS

- * Straight Male Stud Fitting FI-GE
- * Outside Tube Diameter D1 (in mm) -10
- * Series LL
L
S
- * Thread Size 1/4
Please always indicate thread sizes, e.g. 1/4!
- * Thread Type N
NPT Thread
- * Material Code -W3
Steel, zinc/nickel-plated
- * Assembling / Kitting —
Fitting body only
- * -MS
Fitting body supplied with
cutting ring and union nut
- * -MSV
Fitting body supplied with
soft-sealing cutting ring
and union nut

¹ Approx.imate dimension in assembled condition.
² Weight excluding cutting ring and union nut.
³ Standard scope of delivery: Fitting body only.

Male stud acc. to ANSI/ASME B1.20.1-1983
Port acc. to ANSI/ASME B1.20.1-1983

Suitable liquid / plastic sealant required.

Male threaded studs were designed for female threaded ports in components made of steel. For applications with components made of softer mating materials (e.g. Aluminium), the use of connectors with additionally rolled male threads is recommended.
Please contact STAUFF prior to the assembly for further information.

Connecting Parts

-  Cutting Ring
Type FI-DS Page 28
-  Soft-Sealing Cutting Ring
Type FI-WDDS Page 29
-  Support Sleeve
Type FI-VH Page 31
-  STAUFF Form EVO Sealing Ring
Type FI-FD Page 32
-  Union Nut
Type FI-M Page 33
-  37° Flared Tube Fitting Set
Type FI-AB Page 37



Straight Male Stud Fitting
Type FI-GE-...-N • Series S

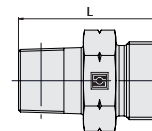
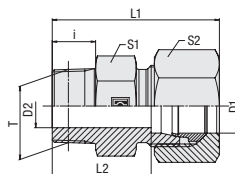

NPT Thread

Ordering Codes

***FI-GE*-10*S*1/4*N*-W3*-MS**

- * Straight Male Stud Fitting FI-GE
- * Outside Tube Diameter D1 (in mm) -10
- * Series LL
 Extra-Light Series (page 65)
 Light Series (pages 65/66) L
 Heavy Series (pages 67/68) S
- * Thread Size 1/4
 acc. to dimension table
 Please always indicate thread sizes, e.g. 1/4!
- * Thread Type N
 NPT Thread
- * Material Code -W3
 Steel, zinc/nickel-plated
 Please contact STAUFF for alternative materials and surface finishings.
- * Assembling / Kitting —
 Fitting body only
 Fitting body supplied with cutting ring and union nut -MS
 Fitting body supplied with soft-sealing cutting ring and union nut -MSV

Series	Tube OD mm D1	PN bar	Dimensions mm									Weight kg ca. per 100	Ordering Codes ³
			Thread T	D2	i	L	L1 ¹	L2	S1	S2			
S	20	400	1/2 NPT	12	20	48	59	37,5	32	36	12,18	FI-GE-20S1/2N-W3	
	20	400	3/4 NPT	16	20	48	59	37,5	32	36	15,05	FI-GE-20S3/4N-W3	
	20	400	1 NPT	16	25	55	66	44,5	36	36	25,37	FI-GE-20S1N-W3	
	25	400	1/2 NPT	20	20	57	59	45	41	46	30,60	FI-GE-25S1/2N-W3	
	25	400	3/4 NPT	16	20	52	64	40	41	46	23,86	FI-GE-25S3/4N-W3	
	25	400	1 NPT	20	25	57	69	45	41	46	28,19	FI-GE-25S1N-W3	
	25	400	1 1/4 NPT	20	26	58	70	46	46	46	47,00	FI-GE-25S1-1/4N-W3	
	30	400	3/4 NPT	16	20	54	67	40,5	46	50	31,29	FI-GE-30S3/4N-W3	
	30	400	1 NPT	20	25	59	72	45,5	46	50	34,70	FI-GE-30S1N-W3	
	30	400	1 1/4 NPT	25	26	60	73	46,5	46	50	36,50	FI-GE-30S1-1/4N-W3	
	30	400	1 1/2 NPT	25	26	60	73	46,5	50	50	36,50	FI-GE-30S1-1/2N-W3	
	38	315	1 NPT	20	25	64	79	48	55	60	53,6	FI-GE-38S1N-W3	
	38	315	1 1/4 NPT	25	26	65	80	49	55	60	50,70	FI-GE-38S1-1/4N-W3	
	38	315	1 1/2 NPT	32	26	65	80	49	55	60	50,70	FI-GE-38S1-1/2N-W3	

¹ Approximate dimension in assembled condition.

² Weight excluding cutting ring and union nut.

³ Standard scope of delivery: Fitting body only.

Male stud acc. to ANSI/ASME B1.20.1-1983

Port acc. to ANSI/ASME B1.20.1-1983

Suitable liquid / plastic sealant required.

Male threaded studs were designed for female threaded ports in components made of steel. For applications with components made of softer mating materials (e.g. Aluminium), the use of connectors with additionally rolled male threads is recommended.

Please contact STAUFF prior to the assembly for further information.

Connecting Parts

-  Cutting Ring
Type **FI-DS** Page 28
-  Soft-Sealing Cutting Ring
Type **FI-WDDS** Page 29
-  Support Sleeve
Type **FI-VH** Page 31
-  STAUFF Form EVO Sealing Ring
Type **FI-FD** Page 32
-  Union Nut
Type **FI-M** Page 33
-  37° Flared Tube Fitting Set
Type **FI-AB** Page 37



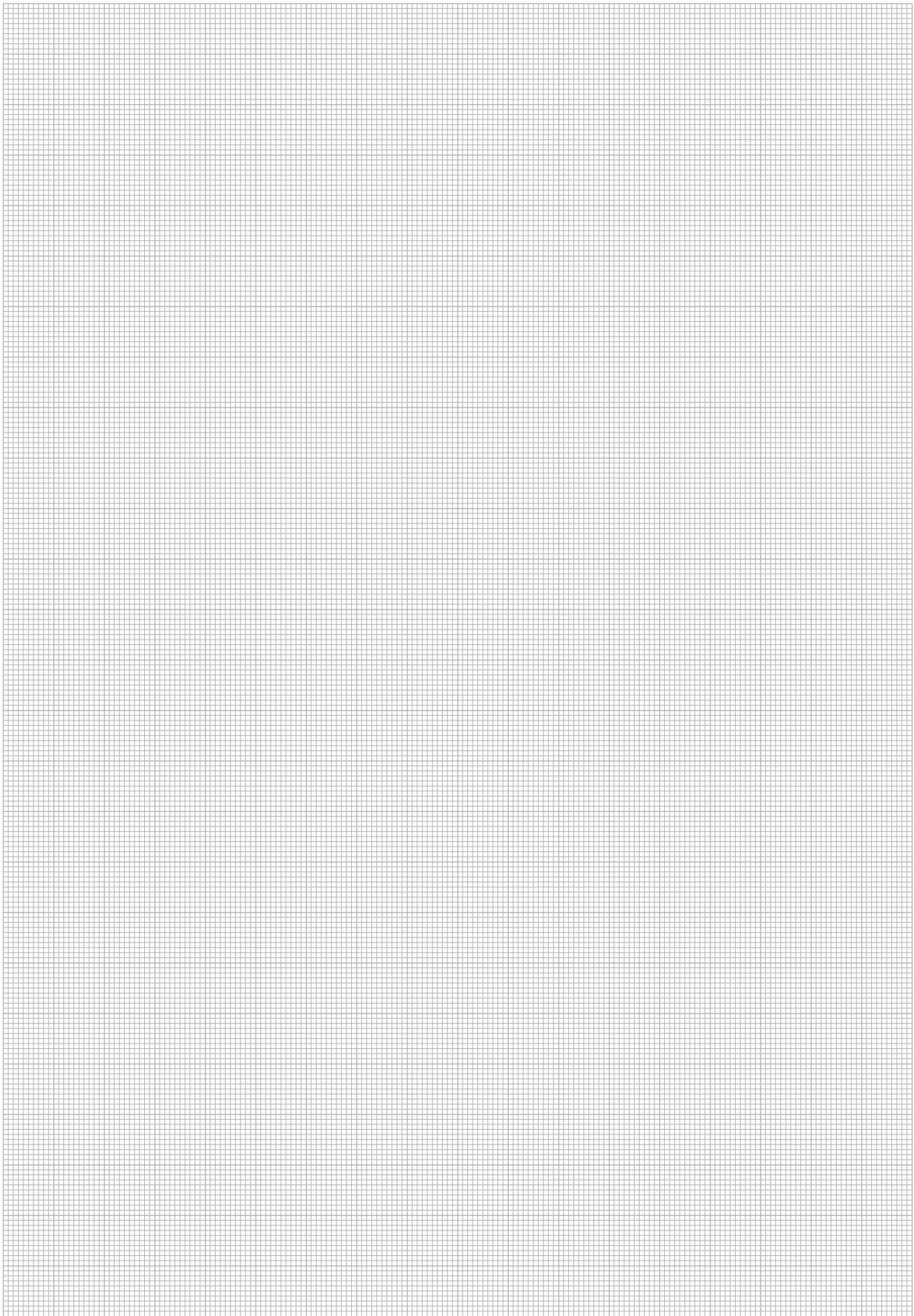

Straight Male Stud Fitting
Type FI-GE-...-U • Series L

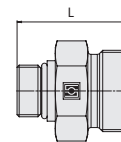
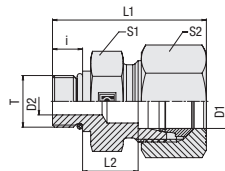

C

Ordering Codes

***FI-GE*-10*L*3/4*U*-B*-W3*-MS**

- * Straight Male Stud Fitting **FI-GE**
- * Outside Tube Diameter D1 (in mm) **-10**
- * Series **L**
Light Series (pages 70/71)
S
Heavy Series (page 71)
- * Thread Size **3/4**
acc. to dimension table
Please always indicate thread sizes, e.g. 3/4!
- * Thread Type **U**
UN/UNF Thread with O-Ring
- * Seal Material **-B**
NBR (Buna-N®)
-V
FKM (Viton®)
- * Material Code **-W3**
Steel, zinc/nickel-plated
Please contact STAUFF for alternative materials and surface finishings.
- * Assembling / Kitting **—**
Fitting body only
Fitting body supplied with cutting ring and union nut **-MS**
Fitting body supplied with soft-sealing cutting ring and union nut **-MSV**

Connecting Parts

-  Cutting Ring
Type **FI-DS** Page 28
-  Soft-Sealing Cutting Ring
Type **FI-WDDS** Page 29
-  Support Sleeve
Type **FI-VH** Page 31
-  STAUFF Form EVO Sealing Ring
Type **FI-FD** Page 32
-  Union Nut
Type **FI-M** Page 33
-  37° Flared Tube Fitting Set
Type **FI-AB** Page 37

Spare Parts / Accessories

-  O-Ring
Type **O-RING** Page 239

UN/UNF Thread

O-Ring

Bau-reihe	Rohr-Ø mm D1	PN bar	Abmessungen mm										Drehm. N-m Gewinde T	Gewicht kg ca. per 100	Bestellbezeichnungen ³
			Gewinde T	D2	i	L	L1 ¹	L2	S1	S2					
L	6	400	7/16-20 UNF	4	9	26	34	10	17	14	18	2,08	FI-GE-06L7/16U-B-W3		
	6	400	9/16-18 UNF	4	10	27	35	10	19	14	30	2,47	FI-GE-06L9/16U-B-W3		
	8	400	7/16-20 UNF	4,5	9	26	34	10	17	17	18	2,18	FI-GE-08L7/16U-B-W3		
	8	400	1/2-20 UNF	6	9	26	34	10	17	17	28	2,21	FI-GE-08L1/2U-B-W3		
	8	400	9/16-18 UNF	6	10	27	35	10	19	17	30	2,76	FI-GE-08L9/16U-B-W3		
	10	400	7/16-20 UNF	4,5	9	27	35	11	17	19	18	2,17	FI-GE-10L7/16U-B-W3		
	10	400	9/16-18 UNF	7,5	10	28	36	11	19	19	30	2,70	FI-GE-10L9/16U-B-W3		
	10	400	3/4-16 UNF	8	11	31	39	13	24	19	50	5,21	FI-GE-10L3/4U-B-W3		
	12	400	7/16-20 UNF	4,5	9	28	35	12	19	22	18	2,77	FI-GE-12L7/16U-B-W3		
	12	400	9/16-18 UNF	7,5	10	28	36	11	19	22	30	3,00	FI-GE-12L9/16U-B-W3		
	12	400	3/4-16 UNF	10	11	31	39	13	24	22	50	4,89	FI-GE-12L3/4U-B-W3		
	12	400	7/8-14 UNF	10	12,7	34	42	14,3	27	22	60	7,48	FI-GE-12L7/8U-B-W3		
	15	400	9/16-18UNF	7,5	10	31	40	14	24	27	30	4,79	FI-GE-15L9/16U-B-W3		
	15	400	3/4-16 UNF	10	11	32	40	14	24	27	50	2,40	FI-GE-15L3/4U-B-W3		
	15	400	7/8-14 UNF	12	12,7	34,7	42,7	15	27	27	60	7,41	FI-GE-15L7/8U-B-W3		
	15	400	1-1/16-12UNF	15	15	39	47	16,5	32	27	95	11,19	FI-GE-15L1-1/16U-B-W3		

¹ Approx.imate dimension in assembled condition.

² Weight excluding cutting ring and union nut.

³ Standard scope of delivery: Fitting body only.

Male stud acc. to ISO 11926-2/-3

Port acc. to ISO 11926-1

Torque recommendations for Steel mating material.

Standard seal material is NBR (Buna-N®).

Male threaded studs were designed for female threaded ports in components made of steel. For applications with components made of softer mating materials (e.g. Aluminium), the use of connectors with additionally rolled male threads is recommended.

Please contact STAUFF prior to the assembly for further information.



Straight Male Stud Fitting
Type FI-GE-...-U • Series L

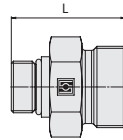
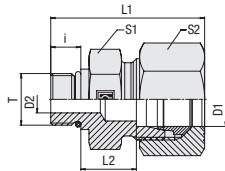

C

UN/UNF Thread

O-Ring

Bau- reihe	Rohr-Ø mm D1	PN bar	Abmessungen mm										Drehm. N-m Gewinde T	Gewicht kg ca. per 100	Bestellbezeichnungen ³
			Gewinde T	D2	i	L	L1 ¹	L2	S1	S2					
L	18	400	3/4-16 UNF	10	11	33	42	14,5	27	32	50	6,86	FI-GE-18L3/4U-B-W3		
	18	400	7/8-14 UNF	12,5	12,7	34,7	43,7	14,5	27	32	60	7,36	FI-GE-18L7/8U-B-W3		
	18	400	1 1/16-12 UNF	15	15	37	45	14,5	32	32	95	11,04	FI-GE-18L1-1/16U-B-W3		
	18	250	1 5/16-12 UNF	21,5	15	15,5	47	15,5	41	32	150	16,08	FI-GE-18L1-5/16U-B-W3		
	22	250	7/8-14 UNF	12,5	12,7	37	46	16,8	32	36	60	9,44	FI-GE-22L7/8U-B-W3		
	22	250	1 1/16-12 UN	18	15	39	48	16,5	32	36	95	10,50	FI-GE-22L1-1/16U-B-W3		
	22	250	1 5/16-12 UN	19	15	40	49	17,5	41	36	150	18,00	FI-GE-22L1-5/16U-B-W3		
	28	250	7/8-14 UNF	12,5	12,7	37,7	45,7	17,5	41	41	60	14,09	FI-GE-28L7/8U-B-W3		
	28	250	1 1/16-12 UN	15	15	40	49	17,5	41	41	95	15,30	FI-GE-28L1-1/16U-B-W3		
	28	250	1 5/16-12 UN	21,5	15	40	49	17,5	41	41	150	17,20	FI-GE-28L1-5/16U-B-W3		
	28	250	1 5/8-12 UN	27,5	15	40	51	17,5	50	41	200	24,51	FI-GE-28L1-5/8U-B-W3		
	35	250	1 5/16-12 UN	21,5	15	43	54	17,5	46	50	150	22,80	FI-GE-35L1-5/16U-B-W3		
	35	250	1 5/8-12 UN	27,5	15	43	54	17,5	50	50	200	28,00	FI-GE-35L1-5/8U-B-W3		
	35	250	1 7/8-12 UN	30	15	45	57	19,5	55	50	325	31,2	FI-GE-35L1-7/8U-B-W3		
	42	250	1 5/8-12 UN	27,5	15	45	57	19	55	60	200	35,36	FI-GE-42L1-5/8U-B-W3		
	42	250	1 7/8-12 UN	33,5	15	45	57	19	55	60	325	35,5	FI-GE-42L1-7/8U-B-W3		

¹ Approx.imate dimension in assembled condition.

² Weight excluding cutting ring and union nut.

³ Standard scope of delivery: Fitting body only.

Male stud acc. to ISO 11926-2/-3

Port acc. to ISO 11926-1

Torque recommendations for Steel mating material.

Standard seal material is NBR (Buna-N®).

Male threaded studs were designed for female threaded ports in components made of steel. For applications with components made of softer mating materials (e.g. Aluminium), the use of connectors with additionally rolled male threads is recommended.

Please contact STAUFF prior to the assembly for further information.

Ordering Codes

FI-GE-10*L*3/4*U*-B*-W3*-MS

* Straight Male Stud Fitting	FI-GE
* Outside Tube Diameter D1 (in mm)	-10
* Series	Light Series (pages 70/71) L Heavy Series (page 71) S
* Thread Size	acc. to dimension table 3/4
Please always indicate thread sizes, e.g. 3/4!	
* Thread Type	UN/UNF Thread with O-Ring U
* Seal Material	NBR (Buna-N®) -B FKM (Viton®) -V
* Material Code	Steel, zinc/nickel-plated -W3

Please contact STAUFF for alternative materials and surface finishings.

* Assembling / Kitting	Fitting body only	—
	Fitting body supplied with cutting ring and union nut	-MS
	Fitting body supplied with soft-sealing cutting ring and union nut	-MSV

Connecting Parts

	Cutting Ring Type FI-DS	Page 28
	Soft-Sealing Cutting Ring Type FI-WDDS	Page 29
	Support Sleeve Type FI-VH	Page 31
	STAUFF Form EVO Sealing Ring Type FI-FD	Page 32
	Union Nut Type FI-M	Page 33
	37° Flared Tube Fitting Set Type FI-AB	Page 37

Spare Parts / Accessories

	O-Ring Type O-RING	Page 239
--	-----------------------	----------



Straight Male Stud Fitting
Type FI-GE-...-U • Series S

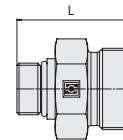
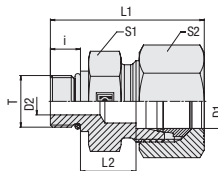

C

O-Ring

UN/UNF Thread

Ordering Codes

***FI-GE*-10*S*3/4*U*-B*-W3*-MS**

- * Straight Male Stud Fitting **FI-GE**
- * Outside Tube Diameter D1 (in mm) **-10**
- * Series Light Series (pages 70/71) **L**
Heavy Series (page 71) **S**
- * Thread Size acc. to dimension table **3/4**
Please always indicate thread sizes, e.g. 3/4!
- * Thread Type UN/UNF Thread with O-Ring **U**
- * Seal Material NBR (Buna-N®) **-B**
FKM (Viton®) **-V**
- * Material Code Steel, zinc/nickel-plated **-W3**
Please contact STAUFF for alternative materials and surface finishings.
- * Assembling / Kitting Fitting body only **—**
Fitting body supplied with cutting ring and union nut **-MS**
Fitting body supplied with soft-sealing cutting ring and union nut **-MSV**

Series	Tube OD mm D1	PN bar	Dimensions mm										Torque N-m	Weight kg ca. per 100	Ordering Codes ³
			Thread	T	D2	i	L	L1 ¹	L2	S1	S2	Thread T			
S	6	630	7/16-20 UNF	4	9	26	36	10	17	17	20	2,16	FI-GE-06S7/16U-B-W3		
	8	630	7/16-20 UNF	4,5	11	29	38	11	17	19	20	2,65	FI-GE-08S7/16U-B-W3		
	8	630	9/16-18 UNF	5	12	32	39,5	12,5	19	19	35	3,91	FI-GE-08S9/16U-B-W3		
	10	630	9/16-18 UNF	7	12	32	41	12,5	19	22	35	3,73	FI-GE-10S9/16U-B-W3		
	10	630	3/4-16 UNF	7	11	33,5	42	15	24	22	70	6,53	FI-GE-10S3/4U-B-W3		
	12	630	9/16-18 UNF	7,5	12	36	45	16,5	24	24	35	6,09	FI-GE-12S9/16U-B-W3		
	12	630	3/4-16 UNF	8	14	36	45	14,5	24	24	70	6,89	FI-GE-12S3/4U-B-W3		
	12	630	3/4-16 UNF	7	16	33,5	42	15	24	22	70	7,56	FI-GE-12S3/4U-B-W3		
	16	630	3/4-16 UNF	10	14	36	45	13,5	24	30	70	6,68	FI-GE-16S3/4U-B-W3		
	16	630	7/8-14 UNF	12	16	39,7	49,7	15,2	27	30	100	9,47	FI-GE-16S7/8U-B-W3		
	16	630	1 1/16-12 UNF	15	18,5	47,5	59	20,5	32	30	170	15,76	FI-GE-16S1-1/16U-B-W3		
	20	420	3/4-16 UNF	10	14	42	53	17,5	32	36	70	11,83	FI-GE-20S3/4U-B-W3		
	20	420	7/8-14 UNF	12,5	16	44	55	17,5	32	36	100	15,20	FI-GE-20S7/8U-B-W3		
	20	420	1 1/16-12 UN	15	18,5	46	57	17	32	36	170	19,70	FI-GE-20S1-1/16U-B-W3		
	20	420	1 5/16-12 UNF	21,5	18,5	48	58	19	41	36	270	22,65	FI-GE-20S1-5/16U-B-W3		
	25	420	1 1/16-12 UN	15	18,5	50	62	19,5	36	46	170	24,20	FI-GE-25S1-1/16U-B-W3		
	25	420	1 5/16-12 UN	20	18,5	50	62	19,5	41	46	270	28,90	FI-GE-25S1-5/16U-B-W3		
	30	420	1 1/16-12 UN	15	18,5	52	66	20	50	50	170	30,45	FI-GE-30S1-1/16U-B-W3		
	30	420	1 5/16-12 UN	21,5	18,5	52	65	20	46	50	270	30,70	FI-GE-30S1-5/16U-B-W3		
	30	420	1 5/8-12 UN	25	18,5	52	65	20	50	50	285	38,10	FI-GE-30S1-5/8U-B-W3		
38	315	1 5/8-12 UN	27,5	18,5	57	72	22,5	55	60	285	47,6	FI-GE-38S1-5/8U-B-W3			
38	315	1 7/8-12 UN	32	18,5	57	72	22,5	55	60	415	50,70	FI-GE-38S1-7/8U-B-W3			

¹ Approximate dimension in assembled condition.

² Weight excluding cutting ring and union nut.

³ Standard scope of delivery: Fitting body only.

Male stud acc. to ISO 11926-2/-3

Port acc. to ISO 11926-1

Torque recommendations for Steel mating material.

Standard seal material is NBR (Buna-N®).

Male threaded studs were designed for female threaded ports in components made of steel. For applications with components made of softer mating materials (e.g. Aluminium), the use of connectors with additionally rolled male threads is recommended.

Please contact STAUFF prior to the assembly for further information.

Connecting Parts

-  Cutting Ring
Type **FI-DS** Page 28
-  Soft-Sealing Cutting Ring
Type **FI-WDDS** Page 29
-  Support Sleeve
Type **FI-VH** Page 31
-  STAUFF Form EVO Sealing Ring
Type **FI-FD** Page 32
-  Union Nut
Type **FI-M** Page 33
-  37° Flared Tube Fitting Set
Type **FI-AB** Page 37

Spare Parts / Accessories

-  O-Ring
Type **O-RING** Page 239



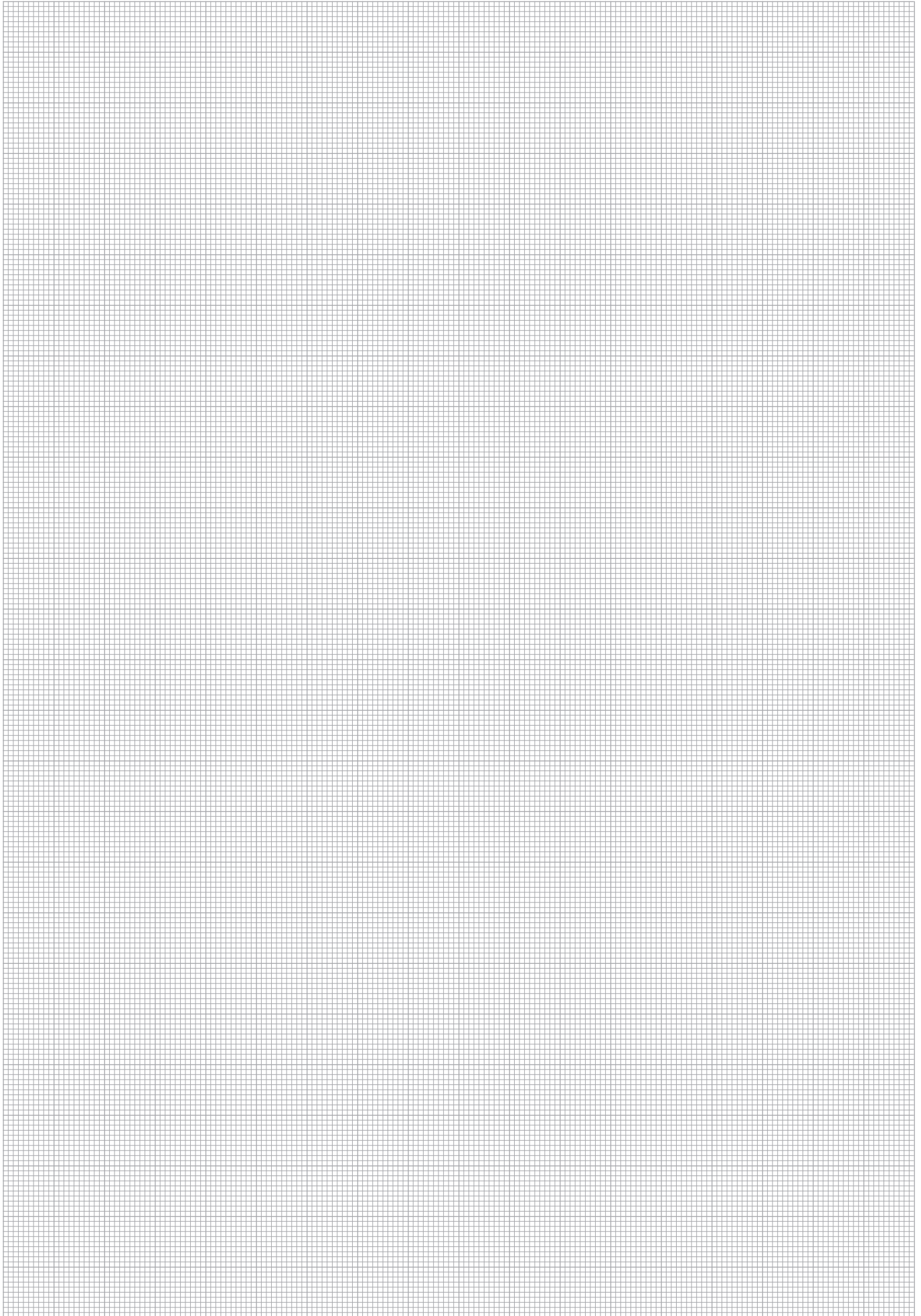

Male Stud Elbow
Type FI-WE-...-R • Series L / S

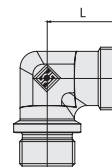
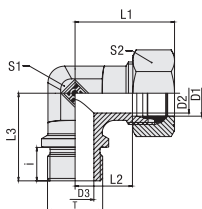

C

Ordering Codes

***FI-WE*-25*S*R*-W3*-MS**

- * Male Stud Elbow FI-WE
- * Outside Tube Diameter D1 (in mm) -25
- * Series L
S
 - Light Series
 - Heavy Series
- * Thread Type R
 - Whitworth Parallel Pipe Thread (BSPP)
- If required, please indicate special sizes, e.g. R3/4!
- * Material Code -W3
 - Steel, zinc/nickel-plated
- Please contact STAUFF for alternative materials and surface finishings.
- * Assembling / Kitting —
-MS
-MSV
 - Fitting body only
 - Fitting body supplied with cutting ring and union nut
 - Fitting body supplied with soft-sealing cutting ring and union nut

Whitworth Parallel Pipe Thread (BSPP)

Metallic Sealing Edge

Series	Tube OD mm	PN bar	Dimensions mm										Torque N-m	Weight kg ca. per 100	Ordering Codes ³
			Thread	T	D2	D3	i	L	L1 ¹	L2	L3	S1			
L	22	160	G 3/4	19	18	16	35	44	27,5	42	27	36	180	1,78	FI-WE-22LR-W3
	28	160	G 1	24	23	18	38	47	30,5	48	36	41	330	3,12	FI-WE-28LR-W3
	35	160	G 1 1/4	30	30	20	45	56	34,5	54	41	50	540	4,67	FI-WE-35LR-W3
	42	160	G 1 1/2	36	36	22	51	63	40	61	50	60	630	6,90	FI-WE-42LR-W3
S	20	420	G 3/4	16	16	16	37	48	26,5	42	27	36	270	2,15	FI-WE-20SR-W3
	25	420	G 3/4	20	18	16	42	54	30	48	36	46	270	3,77	FI-WE-25SR3/4-W3
	25	420	G 1	20	20	18	42	54	30	48	36	46	340	4,06	FI-WE-25SR-W3
	30	250	G 1 1/4	25	25	20	49	62	35,5	54	41	50	540	6,28	FI-WE-30SR-W3
	38	250	G 1 1/2	32	32	22	57	72	41	61	50	60	700	9,15	FI-WE-38SR-W3

¹ Approximate dimension in assembled condition.

² Weight excluding cutting ring and union nut.

³ Standard scope of delivery: Fitting body only.

Male stud acc. to DIN 3852-2 (Form B) / ISO 1179-4 (Type B)
Port acc. to DIN 3852-2 (Form X) / ISO 1179-1

Torque recommendations for Steel mating material.

Male threaded studs were designed for female threaded ports in components made of steel. For applications with components made of softer mating materials (e.g. Aluminium), the use of connectors with additionally rolled male threads is recommended.

Please contact STAUFF prior to the assembly for further information.

Connecting Parts

- Cutting Ring
Type **FI-DS** Page 28
- Soft-Sealing Cutting Ring
Type **FI-WDDS** Page 29
- Support Sleeve
Type **FI-VH** Page 31
- STAUFF Form EVO Sealing Ring
Type **FI-FD** Page 32
- Union Nut
Type **FI-M** Page 33
- 37° Flared Tube Fitting Set
Type **FI-AB** Page 37



Male Stud Elbow
Type FI-WE-...-M • Series L / S

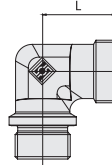
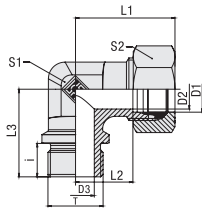

C

Metallic Sealing Edge

Metric Parallel Thread

Series	Tube OD mm	PN bar	Dimensions mm										Torque N-m	Weight kg ca. per 100	Ordering Codes ³
			Thread	T	D2	D3	i	L	L1 ¹	L2	L3	S1			
L	22	250	M 26 x 1,5	19	18	16	35	44	27,5	42	27	36	190	1,73	FI-WE-22LM-W3
	28	250	M 33 x 2	24	23	18	38	47	30,5	48	36	41	340	3,04	FI-WE-28LM-W3
	35	250	M 42 x 2	30	30	20	45	56	34,5	54	41	50	500	4,70	FI-WE-35LM-W3
	42	250	M 48 x 2	36	36	22	51	63	40	61	50	60	630	6,96	FI-WE-42LM-W3
S	20	420	M 27 x 2	16	16	16	37	48	26,5	42	27	36	270	2,14	FI-WE-20SM-W3
	25	250	M 33 x 2	20	20	18	42	54	30	48	36	46	410	4,46	FI-WE-25SM-W3
	30	250	M 42 x 2	25	25	20	49	62	35,5	54	41	50	540	6,33	FI-WE-30SM-W3
	38	250	M 48 x 2	32	32	22	57	72	41	61	50	60	700	9,24	FI-WE-38SM-W3

¹ Approx.imate dimension in assembled condition.

² Weight excluding cutting ring and union nut.

³ Standard scope of delivery: Fitting body only.

Male stud acc. to DIN 3852-1 (Form B) / ISO 9974-3 (Type B)
Port acc. to DIN 3852-1 (Form X) / ISO 9974-1

Torque recommendations for Steel mating material.

Male threaded studs were designed for female threaded ports in components made of steel. For applications with components made of softer mating materials (e.g. Aluminium), the use of connectors with additionally rolled male threads is recommended.

Please contact STAUFF prior to the assembly for further information.

Ordering Codes

FI-WE-25*S*M*-W3*-MS

* Male Stud Elbow		FI-WE
* Outside Tube Diameter D1 (in mm)		-25
* Series	Light Series	L
	Heavy Series	S
* Thread Type	Metric Parallel Thread	M
If required, please indicate special sizes, e.g. M27x2!		
* Material Code	Steel, zinc/nickel-plated	-W3
Please contact STAUFF for alternative materials and surface finishings.		
* Assembling / Kitting	Fitting body only	—
	Fitting body supplied with cutting ring and union nut	-MS
	Fitting body supplied with soft-sealing cutting ring and union nut	-MSV

Connecting Parts

	Cutting Ring Type FI-DS	Page 28
	Soft-Sealing Cutting Ring Type FI-WDDS	Page 29
	Support Sleeve Type FI-VH	Page 31
	STAUFF Form EVO Sealing Ring Type FI-FD	Page 32
	Union Nut Type FI-M	Page 33
	37° Flared Tube Fitting Set Type FI-AB	Page 37



Male Stud Elbow
Type FI-WE-...-Rk ▪ Series LL / L

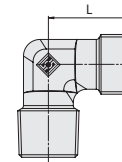
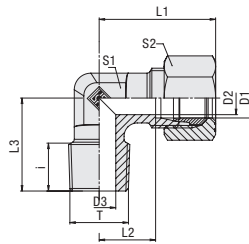

C



Whitworth Taper Pipe Thread (BSPT)

Ordering Codes

***FI-WE*-10*L*Rk*-W3*-MS**

* Male Stud Elbow		FI-WE
* Outside Tube Diameter D1 (in mm)		-10
* Series	Extra-Light Series (page 76) Light Series (page 76) Heavy Series (page 77)	LL L S
* Thread Type	Whitworth Taper Pipe Thread (BSPT)	Rk
If required, please indicate special sizes, e.g. R3/8k!		
* Material Code	Steel, zinc/nickel-plated	-W3
Please contact STAUFF for alternative materials and surface finishings.		
* Design	Made from forging blanks Made from profile material	— PR
* Assembling / Kitting	Fitting body only	—
	Fitting body supplied with cutting ring and union nut	-MS
	Fitting body supplied with soft-sealing cutting ring and union nut	-MSV

Series	Tube OD mm	PN bar	Dimensions mm										Weight kg ca. per 100	Ordering Codes ³
			Thread	T	D2	D3	i	L	L1 ¹	L2	L3	S1		
LL	4	100	R 1/8 keg.	3	3	8	15	21	11	17	11	10	1,46	FI-WE-04LLRk-W3-PR
	6	100	R 1/8 keg.	4,5	4,5	8	15	21	9,5	17	11	12	1,73	FI-WE-06LLRk-W3-PR
	8	100	R 1/8 keg.	6	6	8	17	23	11,5	20	12	14	2,63	FI-WE-08LLRk-W3-PR
	10	100	R 1/4 keg.	8	7	12	21,5	27,5	16	26	14	14	9,10	FI-WE-10LLRk-W3
L	12	100	R 1/4 keg.	10	7	9,9	22	28	16	23	14	17	11,40	FI-WE-12LLRk-W3
	6	315	R 1/8 keg.	4	4	8	19	27	12	20	12	14	1,96	FI-WE-06LRk-W3
	6	315	R 1/4 keg.	4	6	12	21	29	14	25,5	12	14	2,93	FI-WE-06LR1/4k-W3
	6	315	R 3/8 keg.	4	9	12	24	31	17	28	14	14	4,42	FI-WE-06LR3/8k-W3
	8	315	R 1/8 keg.	6	4	8	21	29	14	26	12	17	2,64	FI-WE-08LR1/8k-W3
	8	315	R 1/4 keg.	6	6	12	21	29	14	26	12	17	2,93	FI-WE-08LRk-W3
	8	315	R 3/8 keg.	6	9	14	24	32	17	28	14	17	4,34	FI-WE-08LR3/8k-W3
	10	315	R 1/8 keg.	8	6	7,3	22,5	29	15,5	20	14	19	2,96	FI-WE-10LR1/8k-W3
	10	315	R 1/4 keg.	8	7	13	22	30	15	27	14	19	3,53	FI-WE-10LRk-W3
	10	315	R 3/8 keg.	8	8	12,5	22	30	15	28	14	19	4,29	FI-WE-10LR3/8k-W3
	10	315	R 1/2 keg.	8	11	14	28	35	21	34	19	19	9,56	FI-WE-10LR1/2k-W3
	12	315	R 1/4 keg.	10	7	14,3	24	32	17	27	17	22	4,57	FI-WE-12LR1/4k-W3
	12	315	R 3/8 keg.	10	9	13	24	32	17	28,5	17	22	5,33	FI-WE-12LRk-W3
	12	315	R 1/2 keg.	10	10	14	28	36	21	34	19	22	9,94	FI-WE-12LR1/2k-W3
	15	315	R 3/8 keg.	12	9	14	28	36	21	34	19	27	8,79	FI-WE-15LR3/8k-W3
	15	315	R 1/2 keg.	12	12	16	28	36	21	34	19	27	9,12	FI-WE-15LRk-W3
	15	315	R 3/4 keg.	12	12	17	33	40	26	36	24	27	4,05	FI-WE-15LR3/4k-W3
	18	315	R 1/2 keg.	15	14	17,5	31	40	23,5	36	24	32	11,63	FI-WE-18LRk-W3
	18	315	R 3/4 keg.	15	16	16	31	41,5	23,5	36	27	32	13,2	FI-WE-18LR3/4k-W3
	22	160	R 3/4 keg.	19	18	17	35	44	28,5	42,5	27	36	16,80	FI-WE-22LRk-W3
28	160	R 1 keg.	24	23	20	38	47	30,5	48	36	41	30,7	FI-WE-28LRk-W3	
35	160	R 1 1/4 keg.	30	30	20	48	59	37,5	51	41	50	46,7	FI-WE-35LRk-W3	
42	160	R 1 1/2 keg.	36	36	20	54	59	43	61	50	60	72,3	FI-WE-42LRk-W3	

Connecting Parts

	Cutting Ring Type FI-DS	Page 28
	Soft-Sealing Cutting Ring Type FI-WDDS	Page 29
	Support Sleeve Type FI-VH	Page 31
	STAUFF Form EVO Sealing Ring Type FI-FD	Page 32
	Union Nut Type FI-M	Page 33
	37° Flared Tube Fitting Set Type FI-AB	Page 37

¹ Approximate dimension in assembled condition.

² Weight excluding cutting ring and union nut.

³ Standard scope of delivery: Fitting body only.

Male stud acc. to DIN 3852-2 (Form C)

Port acc. to DIN 3852-2 (Form Z)

Suitable liquid / plastic sealant required.

Male threaded studs were designed for female threaded ports in components made of steel. For applications with components made of softer mating materials (e.g. Aluminium), the use of connectors with additionally rolled male threads is recommended.

Please contact STAUFF prior to the assembly for further information.



Male Stud Elbow
Type FI-WE-...-Rk ▪ Series S

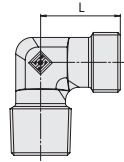
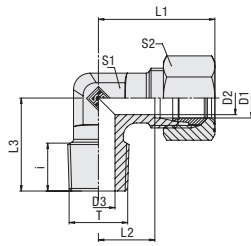

C

Whitworth Taper Pipe Thread (BSPT)

Series	Tube OD mm	PN bar	Dimensions mm	Dimensions													Weight kg ca. per 100	Ordering Codes ³
				Thread T	D2	D3	i	L	L1 ¹	L2	L3	S1	S2					
S	6	400	R 1/4 keg.	4	4	12	23	31	16	26	12	17	5,73	FI-WE-06SRk-W3				
	8	400	R 1/4 keg.	5	5	13	24	32	17	27	14	19	4,70	FI-WE-08SRk-W3				
	10	400	R 1/4 keg.	7	5	13	25	34	17,5	28	17	22	5,94	FI-WE-10SR1/4k-W3				
	10	400	R 3/8 keg.	7	7	13	25	34	17,5	28	17	22	6,71	FI-WE-10SRk-W3				
	10	400	R 1/2 keg.	7	7	13	30	38	22,5	32	19	22	11,67	FI-WE-10SR1/2k-W3				
	12	400	R 3/8 keg.	8	7	12	29	38	21,5	28	17	24	7,78	FI-WE-12SRk-W3				
	12	400	R 1/2 keg.	8	10	14	30	39	22,5	32	19	24	4,67	FI-WE-12SR1/2k-W3				
	14	400	R 3/8 keg.	10	8	14	30	40	22	32	19	27	9,62	FI-WE-14SR3/8k-W3				
	14	400	R 1/2 keg.	10	10	14	30	40	22	32	19	27	10,53	FI-WE-14SRk-W3				
	16	400	R 1/2 keg.	12	12	14	34	44	25,5	32	24	30	13,60	FI-WE-16SRk-W3				
	16	400	R 3/4 keg.	12	12	14	34	44	25,5	32	24	30	22,00	FI-WE-16SR3/4k-W3				
	20	400	R 1/2 keg.	16	10	14	37	48	26,5	42	27	36	21,00	FI-WE-20SR1/2k-W3				
	20	250	R 3/4 keg.	16	16	17	39	48	26,5	42	27	36	21,19	FI-WE-20SRk-W3				
	25	250	R 3/4 keg.	20	16	17	42	53	30	48	36	46	37,27	FI-WE-25SR3/4k-W3				
	25	250	R 1 keg.	20	20	20	42	53	30	48	36	46	39,3	FI-WE-25SRk-W3				
	30	250	R 1 1/4 keg.	25	25	20	52	62	35,5	54	41	50	62,61	FI-WE-30SRk-W3				
	38	250	R 1 1/2 keg.	32	32	20	52	71	41	61	50	60	93,8	FI-WE-38SRk-W3				

¹ Approx.imate dimension in assembled condition.

² Weight excluding cutting ring and union nut.

³ Standard scope of delivery: Fitting body only.

Male stud acc. to DIN 3852-2 (Form C)

Port acc. to DIN 3852-2 (Form Z)

Suitable liquid / plastic sealant required.

Male threaded studs were designed for female threaded ports in components made of steel. For applications with components made of softer mating materials (e.g. Aluminium), the use of connectors with additionally rolled male threads is recommended.

Please contact STAUFF prior to the assembly for further information.

Ordering Codes

FI-WE-10*S*Rk*-W3*-MS

* Male Stud Elbow	FI-WE
* Outside Tube Diameter D1 (in mm)	-10
* Series	Extra-Light Series (page 76) LL Light Series (page 76) L Heavy Series (page 77) S
* Thread Type	Whitworth Taper Pipe Thread (BSPT) Rk
If required, please indicate special sizes, e.g. R3/8k!	
* Material Code	Steel, zinc/nickel-plated -W3
Please contact STAUFF for alternative materials and surface finishings.	
* Assembling / Kitting	Fitting body only — Fitting body supplied with cutting ring and union nut -MS Fitting body supplied with soft-sealing cutting ring and union nut -MSV

Connecting Parts

	Cutting Ring Type FI-DS	Page 28
	Soft-Sealing Cutting Ring Type FI-WDDS	Page 29
	Support Sleeve Type FI-VH	Page 31
	STAUFF Form EVO Sealing Ring Type FI-FD	Page 32
	Union Nut Type FI-M	Page 33
	37° Flared Tube Fitting Set Type FI-AB	Page 37



Male Stud Elbow
Type FI-WE-...-Mk ▪ Series LL / L / S

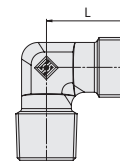
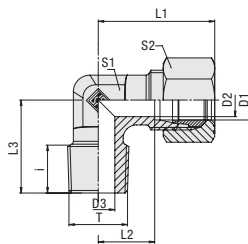

Metric Taper Thread

Ordering Codes

***FI-WE*-10*L*Mk*-W3*-MS**

* Male Stud Elbow		FI-WE
* Outside Tube Diameter D1 (in mm)		-10
* Series	Extra-Light Series	LL
	Light Series	L
	Heavy Series	S
* Thread Type	Metric Taper Thread	Mk
If required, please indicate special sizes, e.g. M12x1.5k!		
* Material Code	Steel, zinc/nickel-plated	-W3
Please contact STAUFF for alternative materials and surface finishings.		
* Design	Made from forging blanks	—
	Made from profile material	PR
* Assembling / Kitting	Fitting body only	—
	Fitting body supplied with cutting ring and union nut	-MS
	Fitting body supplied with soft-sealing cutting ring and union nut	-MSV

Series	Tube OD mm	PN bar	Dimensions mm										Weight kg ca. per 100	Ordering Codes ³	
			Thread	T	D2	D3	i	L	L1 ¹	L2	L3	S1			S2
LL	4	100	M 6 x 1 keg.	3	2	8,5	15	20	11	17	9	10	1,34	FI-WE-04LLM6x1k-W3-PR	
	4	100	M 8 x 1 keg.	3	3,5	8	15	21	11	17	9	10	1,46	FI-WE-04LLMk-W3-PR	
	6	100	M 6 x 1 keg.	4,5	2	8	15	21	9,5	15	11	12	1,44	FI-WE-06LLM6x1k-W3-PR	
	6	100	M 8 x 1 keg.	4,5	3,5	8,5	15	21	9,5	17	11	12	1,64	FI-WE-06LLM8x1k-W3-PR	
	6	100	M 10 x 1 keg.	4,5	4,5	8	15	21	9,5	17	11	12	1,74	FI-WE-06LLMk-W3-PR	
	8	100	M 10 x 1 keg.	6	6	8	17	23	11,5	20	12	14	2,82	FI-WE-08LLMk-W3-PR	
	L	6	315	M 10 x 1 keg.	4	4	8	19	27	12	20	12	14	2,16	FI-WE-06LMk-W3
		8	315	M 12 x 1,5 keg.	6	6	12	21	29	14	26	12	17	2,67	FI-WE-08LMk-W3
10		315	M 14 x 1,5 keg.	8	7	11,5	22	30	15	27	14	19	4,19	FI-WE-10LMk-W3	
12		315	M 16 x 1,5 keg.	10	9	11,5	24	32	17	28	17	22	5,05	FI-WE-12LMk-W3	
12		315	M 18 x 1,5 keg.	10	10	11,5	29	36	22	28	17	22	5,79	FI-WE-12LM18x1.5k-W3	
15		315	M 18 x 1,5 keg.	12	11	12	28	36	21	32	19	27	8,82	FI-WE-15LMk-W3	
18		315	M 22 x 1,5 keg.	15	14	14	31	40	23,5	36	24	32	12,56	FI-WE-18LMk-W3	
S		6	400	M 12 x 1,5 keg.	4	4	12	23	31	16	26	12	17	3,44	FI-WE-06SMk-W3
	8	400	M 14 x 1,5 keg.	5	5	11,5	24	32	17	27	14	19	5,33	FI-WE-08SMk-W3	
	10	400	M 16 x 1,5 keg.	7	7	11,5	25	34	17,5	28	17	22	6,35	FI-WE-10SMk-W3	
	12	400	M 18 x 1,5 keg.	8	8	12	29	38	21,5	28	17	24	8,19	FI-WE-12SMk-W3	
	14	400	M 20 x 1,5 keg.	10	10	14	30	40	22	32	19	27	11,45	FI-WE-14SMk-W3	
	16	400	M 22 x 1,5 keg.	12	12	14	33	43	24,5	32	24	30	9,62	FI-WE-16SMk-W3	

¹ Approximate dimension in assembled condition.

² Weight excluding cutting ring and union nut.

³ Standard scope of delivery: Fitting body only.

Male stud acc. to DIN 3852-1 (Form C)

Port acc. to DIN 3852-1 (Form Z)

Suitable liquid / plastic sealant required.

Male threaded studs were designed for female threaded ports in components made of steel. For applications with components made of softer mating materials (e.g. Aluminium), the use of connectors with additionally rolled male threads is recommended.

Please contact STAUFF prior to the assembly for further information.

Connecting Parts

	Cutting Ring Type FI-DS	Page 28
	Soft-Sealing Cutting Ring Type FI-WDDS	Page 29
	Support Sleeve Type FI-VH	Page 31
	STAUFF Form EVO Sealing Ring Type FI-FD	Page 32
	Union Nut Type FI-M	Page 33
	37° Flared Tube Fitting Set Type FI-AB	Page 37



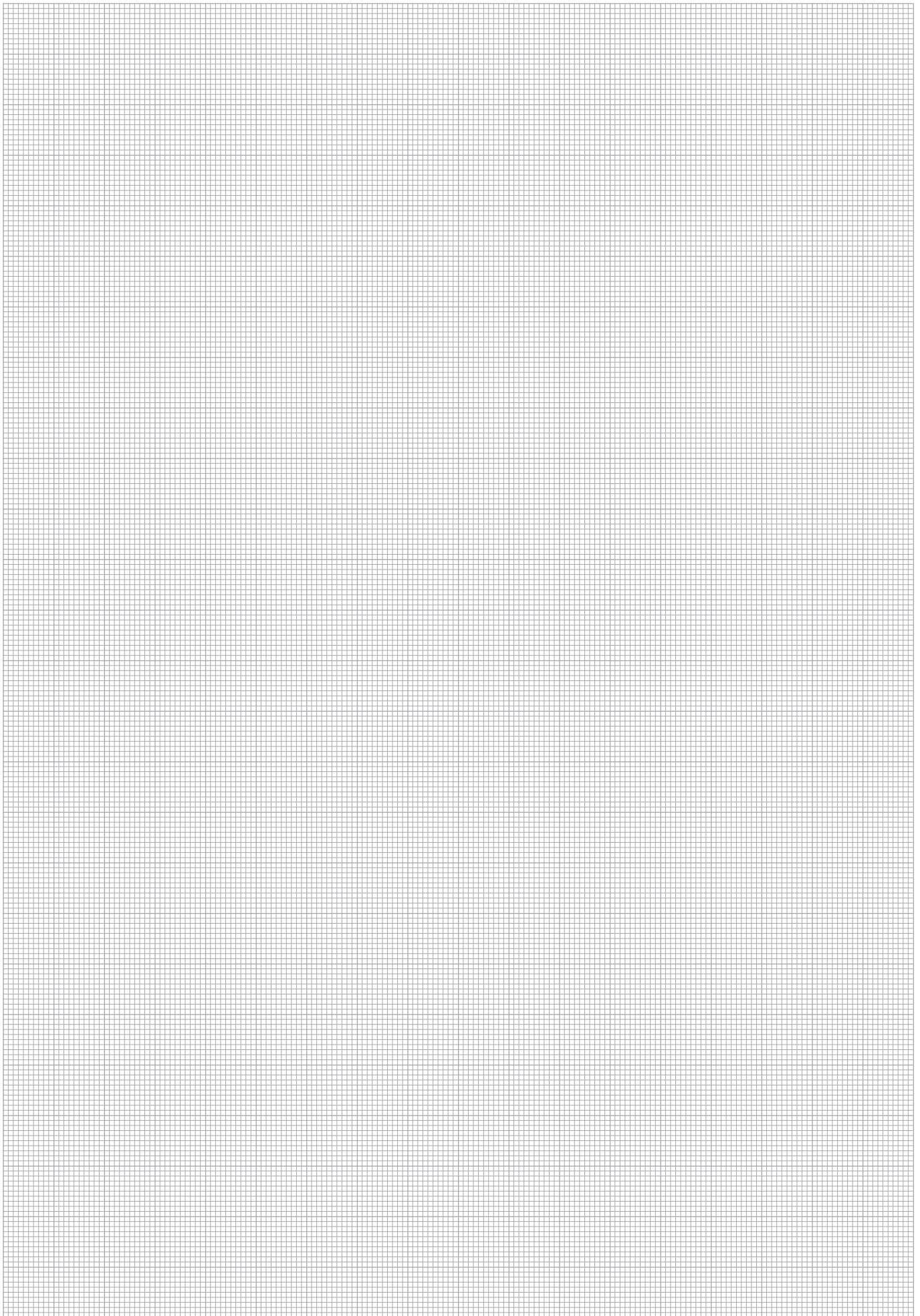

Male Stud Elbow
Type FI-WE-...-N • Series LL / L

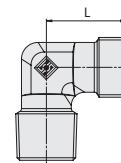
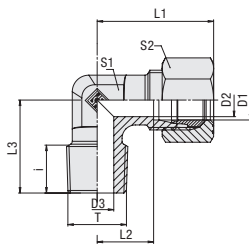

C



Ordering Codes

***FI-WE*-10*L*1/4*N*-W3*-MS**

- * Male Stud Elbow **FI-WE**
- * Outside Tube Diameter D1 (in mm) **-10**
- * Series **LL**
 Extra-Light Series (page 80)
 Light Series (page 80)
 Heavy Series (page 81)
L
S
- * Thread Size **1/4**
 acc. to dimension table
 Please always indicate thread sizes, e.g. 1/4!
- * Thread Type **N**
 NPT Thread
- * Material Code **-W3**
 Steel, zinc/nickel-plated
 Please contact STAUFF for alternative materials and surface finishings.
- * Design **—**
 Made from forging blanks
 Made from profile material **PR**
- * Assembling / Kitting **—**
 Fitting body only
 Fitting body supplied with cutting ring and union nut **-MS**
 Fitting body supplied with soft-sealing cutting ring and union nut **-MSV**

NPT Thread

Series	Tube OD mm	PN bar	Dimensions mm											Weight kg ca. per 100	Ordering Codes ³
			Thread	T	D2	D3	i	L	L1 ¹	L2	L3	S1	S2		
LL	4	100	1/8 NPT	3	4	8	15	21	11	15,6	11	10	1,81	FI-WE-04LL1/8N-W3-PR	
	6	100	1/8 NPT	4,5	4,5	8	15	21	9,5	17	11	12	1,57	FI-WE-06LL1/8N-W3-PR	
	8	100	1/8 NPT	6	6	10	17	23	11,5	20	12	14	2,64	FI-WE-08LL1/8N-W3-PR	
L	6	315	1/8 NPT	4	5	8	19	27	11,5	20	12	14	1,91	FI-WE-06L1/8N-W3	
	6	315	1/4 NPT	4	7	10	21	29	14	26	14	14	2,80	FI-WE-06L1/4N-W3	
	6	315	3/8 NPT	4	8	10,5	25	33	18	28	17	14	5,63	FI-WE-06L3/8N-W3	
	8	315	1/8 NPT	6	4	7	21	29	14	26	12	17	2,36	FI-WE-08L1/8N-W3	
	8	315	1/4 NPT	6	6	11,4	21	29	14	26	12	17	2,92	FI-WE-08L1/4N-W3	
	10	315	1/4 NPT	8	7	11,4	22	30	15	27	14	19	3,56	FI-WE-10L1/4N-W3	
	10	315	3/8 NPT	8	8	10,5	24	32	17	28	17	19	5,67	FI-WE-10L3/8N-W3	
	12	315	1/4 NPT	10	7	11,4	24	32	17	28	17	22	4,81	FI-WE-12L1/4N-W3	
	12	315	3/8 NPT	10	8	10,5	24	32	17	28	17	22	4,87	FI-WE-12L3/8N-W3	
	12	315	1/2 NPT	10	11	14	28	36	21	34	19	22	7,99	FI-WE-12L1/2N-W3	
	15	315	1/2 NPT	12	14	14	28	39	21	34	19	27	8,05	FI-WE-15L1/2N-W3	
	18	315	1/2 NPT	15	12	14	31	40	23,5	36	24	32	12,79	FI-WE-18L1/2N-W3	
	22	160	3/4 NPT	19	16	14	35	44	27,5	42	27	36	17,07	FI-WE-22L3/4N-W3	
	28	160	1 NPT	24	21	17,5	38	47	30,5	48	36	41	32,40	FI-WE-28L1N-W3	
	35	160	1 1/4 NPT	30	28	18	48	59	34,5	54	41	50	51,70	FI-WE-35L1-1/4N-W3	
42	160	1 1/2 NPT	36	34	18,5	54	66	43	61	50	60	74,60	FI-WE-42L1-1/2N-W3		

¹ Approximate dimension in assembled condition.

² Weight excluding cutting ring and union nut.

³ Standard scope of delivery: Fitting body only.

Male stud acc. to ANSI/ASME B1.20.1-1983

Port acc. to ANSI/ASME B1.20.1-1983

Suitable liquid / plastic sealant required.

Male threaded studs were designed for female threaded ports in components made of steel. For applications with components made of softer mating materials (e.g. Aluminium), the use of connectors with additionally rolled male threads is recommended.

Please contact STAUFF prior to the assembly for further information.

Connecting Parts

-  Cutting Ring
Type **FI-DS** Page 28
-  Soft-Sealing Cutting Ring
Type **FI-WDDS** Page 29
-  Support Sleeve
Type **FI-VH** Page 31
-  STAUFF Form EVO Sealing Ring
Type **FI-FD** Page 32
-  Union Nut
Type **FI-M** Page 33
-  37° Flared Tube Fitting Set
Type **FI-AB** Page 37



Male Stud Elbow
Type FI-WE-...-N • Series S

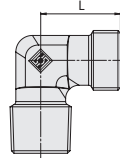
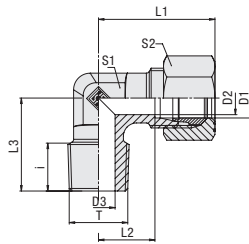

C

NPT Thread

Series	Tube OD mm	PN bar	Dimensions mm										Weight kg ca. per 100	Ordering Codes ³
			Thread	T	D2	D3	i	L	L1 ¹	L2	L3	S1		
S	6	630	1/4 NPT	4	4	10	23	31	16	26	12	17	3,19	FI-WE-06S1/4N-W3
	8	630	1/4 NPT	5	5	10	24	32	17	27	14	19	4,41	FI-WE-08S1/4N-W3
	8	630	3/8 NPT	5	8	10,5	25	33	18	28	17	19	7,80	FI-WE-08S3/8N-W3
	8	630	1/2 NPT	5	10	14	30	38	23	34	19	19	8,30	FI-WE-08S1/2N-W3
	10	630	1/4 NPT	7	5	10	25	34	17,5	28	17	22	6,17	FI-WE-10S1/4N-W3
	10	630	3/8 NPT	7	7	10,5	25	34	17,5	28	17	22	6,64	FI-WE-10S3/8N-W3
	12	630	1/4 NPT	8	5	11,4	29	38	21,5	29	17	24	7,87	FI-WE-12S1/4N-W3
	12	630	3/8 NPT	8	8	10,5	29	38	21,5	28	17	24	7,76	FI-WE-12S3/8N-W3
	12	630	1/2 NPT	8	10	14	30	39	22,5	34	19	24	11,23	FI-WE-12S1/2N-W3
	14	630	1/2 NPT	10	10	14	30	40	22	34	19	27	8,88	FI-WE-14S1/2N-W3
	16	630	1/2 NPT	12	12	14	33	43	24,5	36	24	30	14,05	FI-WE-16S1/2N-W3
	20	400	3/4 NPT	16	16	14	37	48	26,5	42	27	36	19,28	FI-WE-20S3/4N-W3
	25	400	1 NPT	20	20	17,5	42	54	30	48	36	46	33,76	FI-WE-25S1N-W3
	30	400	1 1/4 NPT	25	25	18	49	62	35,5	54	41	50	60,30	FI-WE-30S1-1/4N-W3
	38	315	1 1/2 NPT	32	32	18,5	58	73	40	61	50	60	91,80	FI-WE-38S1-1/2N-W3

¹ Approx.imate dimension in assembled condition.

² Weight excluding cutting ring and union nut.

³ Standard scope of delivery: Fitting body only.

Male stud acc. to ANSI/ASME B1.20.1-1983

Port acc. to ANSI/ASME B1.20.1-1983

Suitable liquid / plastic sealant required.

Male threaded studs were designed for female threaded ports in components made of steel. For applications with components made of softer mating materials (e.g. Aluminium), the use of connectors with additionally rolled male threads is recommended.

Please contact STAUFF prior to the assembly for further information.

Ordering Codes

***FI-WE*-10*S*1/4*N*-W3*-MS**

* Male Stud Elbow	FI-WE
* Outside Tube Diameter D1 (in mm)	-10
* Series	Extra-Light Series (page 80) LL Light Series (page 80) L Heavy Series (page 81) S
* Thread Size	acc. to dimension table 1/4
Please always indicate thread sizes, e.g. 1/4!	
* Thread Type	NPT Thread N
* Material Code	Steel, zinc/nickel-plated -W3
Please contact STAUFF for alternative materials and surface finishings.	
* Assembling / Kitting	Fitting body only —
	Fitting body supplied with cutting ring and union nut -MS
	Fitting body supplied with soft-sealing cutting ring and union nut -MSV

Connecting Parts

	Cutting Ring Type FI-DS	Page 28
	Soft-Sealing Cutting Ring Type FI-WDDS	Page 29
	Support Sleeve Type FI-VH	Page 31
	STAUFF Form EVO Sealing Ring Type FI-FD	Page 32
	Union Nut Type FI-M	Page 33
	37° Flared Tube Fitting Set Type FI-AB	Page 37



Male Stud Branch Tee
Type FI-TE-...-R ▪ Series L / S

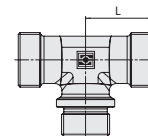
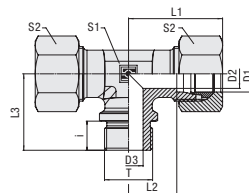

C

Ordering Codes

***FI-TE*-22*L*R*-W3*-MS**

- * Male Stud Branch Tee FI-TE
- * Outside Tube Diameter D1 (in mm) -22
- * Series L
S
 - Light Series
 - Heavy Series
- * Thread Type R
 - Whitworth Parallel Pipe Thread (BSPP)
- If required, please indicate special sizes, e.g. R1/2!
- * Material Code -W3
 - Steel, zinc/nickel-plated
- Please contact STAUFF for alternative materials and surface finishings.
- * Assembling / Kitting —
 - Fitting body only
 - Fitting body supplied with cutting rings and union nuts -MS
 - Fitting body supplied with soft-sealing cutting rings and union nuts -MSV

Whitworth Parallel Pipe Thread (BSPP)

Metallic Sealing Edge

Series	Tube OD mm D1	PN bar	Dimensions mm											Torque N-m Thread T	Weight kg ca. per 100	Ordering Codes ³
			Thread T	D2	D3	i	L	L1 ¹	L2	L3	S1	S2				
L	22	160	G 3/4	19	18	16	35	44	27,5	42	27	36	180	23,90	FI-TE-22LR-W3	
	28	160	G 1	24	23	18	38	47	30,5	48	36	41	330	37,50	FI-TE-28LR-W3	
	35	160	G 1 1/4	30	30	20	45	56	34,5	54	41	50	540	56,50	FI-TE-35LR-W3	
	42	160	G 1 1/2	36	36	22	51	63	40	61	50	60	630	80,50	FI-TE-42LR-W3	
S	20	400	G 3/4	16	16	16	37	48	26,5	42	27	36	270	28,80	FI-TE-20SR-W3	
	25	250	G 1	20	20	18	42	54	30	48	36	46	340	51,40	FI-TE-25SR-W3	
	30	160	G 1 1/4	25	25	20	49	62	35,5	54	41	50	540	79,20	FI-TE-30SR-W3	
	38	160	G 1 1/2	32	32	22	57	72	41	61	50	60	700	114,50	FI-TE-38SR-W3	

¹ Approx.imate dimension in assembled condition.

² Weight excluding cutting rings and union nuts.

³ Standard scope of delivery: Fitting body only.

Male stud acc. to DIN 3852-2 (Form B) / ISO 1179-4 (Type B)
Port acc. to DIN 3852-2 (Form X) / ISO 1179-1

Torque recommendations for Steel mating material.

Male threaded studs were designed for female threaded ports in components made of steel. For applications with components made of softer mating materials (e.g. Aluminium), the use of connectors with additionally rolled male threads is recommended.

Please contact STAUFF prior to the assembly for further information.

Connecting Parts

- Cutting Ring
Type **FI-DS** Page 28
- Soft-Sealing Cutting Ring
Type **FI-WDDS** Page 29
- Support Sleeve
Type **FI-VH** Page 31
- STAUFF Form EVO Sealing Ring
Type **FI-FD** Page 32
- Union Nut
Type **FI-M** Page 33
- 37° Flared Tube Fitting Set
Type **FI-AB** Page 37

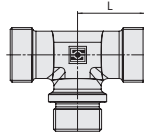
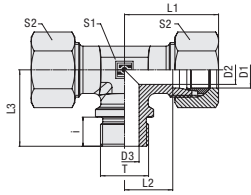

**Male Stud Branch Tee
Type FI-TE-...-M • Series L / S**

C
Metallic Sealing Edge
Metric Parallel Thread

Series	Tube OD mm	PN bar	Dimensions mm											Torque N-m	Weight kg ca. per 100	Ordering Codes ³
			Thread	T	D2	D3	i	L	L1 ¹	L2	L3	S1	S2			
L	22	160	M 26 x 1,5	19	18	16	35	44	27,5	42	27	36	190	22,20	FI-TE-22LM-W3	
	28	160	M 33 x 2	24	23	18	38	47	30,5	48	36	41	340	37,60	FI-TE-28LM-W3	
	35	160	M 42 x 2	30	30	20	45	56	34,5	54	41	50	500	56,90	FI-TE-35LM-W3	
	42	160	M 48 x 2	36	36	22	51	63	40	61	50	60	630	81,10	FI-TE-42LM-W3	
S	20	400	M 27 x 2	16	16	16	37	48	26,5	42	27	36	270	29,10	FI-TE-20SM-W3	
	25	250	M 33 x 2	20	20	18	42	54	30	48	36	46	410	51,10	FI-TE-25SM-W3	
	30	160	M 42 x 2	25	25	20	49	62	35,5	54	41	50	540	79,60	FI-TE-30SM-W3	
	38	160	M 48 x 2	32	32	22	57	72	41	61	50	60	700	115,10	FI-TE-38SM-W3	

¹ Approx.imate dimension in assembled condition.

² Weight excluding cutting rings and union nuts.

³ Standard scope of delivery: Fitting body only.

 Male stud acc. to DIN 3852-1 (Form B) / ISO 9974-3 (Type B)
 Port acc. to DIN 3852-1 (Form X) / ISO 9974-1

Torque recommendations for Steel mating material.

Male threaded studs were designed for female threaded ports in components made of steel. For applications with components made of softer mating materials (e.g. Aluminium), the use of connectors with additionally rolled male threads is recommended.

Please contact STAUFF prior to the assembly for further information.

Ordering Codes
***FI-TE*-22*L*M*-W3*-MS**

* Male Stud Branch Tee		FI-TE
* Outside Tube Diameter D1 (in mm)		-22
* Series	Light Series	L
	Heavy Series	S
* Thread Type	Metric Parallel Thread	M
If required, please indicate special sizes, e.g. M27x2!		
* Material Code	Steel, zinc/nickel-plated	-W3
Please contact STAUFF for alternative materials and surface finishings.		
* Assembling / Kitting	Fitting body only	—
	Fitting body supplied with cutting rings and union nuts	-MS
	Fitting body supplied with soft-sealing cutting rings and union nuts	-MSV

Connecting Parts

	Cutting Ring Type FI-DS	Page 28
	Soft-Sealing Cutting Ring Type FI-WDDS	Page 29
	Support Sleeve Type FI-VH	Page 31
	STAUFF Form EVO Sealing Ring Type FI-FD	Page 32
	Union Nut Type FI-M	Page 33
	37° Flared Tube Fitting Set Type FI-AB	Page 37



Male Stud Branch Tee
Type FI-TE-...-Rk ▪ Series LL / L / S

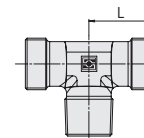
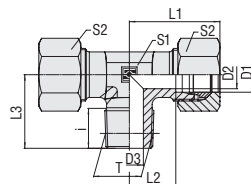

C

Whitworth Taper Pipe Thread (BSPT)

Ordering Codes

***FI-TE*-10*L*Rk*-W3*-MS**

- * Male Stud Branch Tee **FI-TE**
- * Outside Tube Diameter D1 (in mm) **-10**
- * Series **LL**
 Extra-Light Series
 Light Series **L**
 Heavy Series **S**
- * Thread Type **Rk**
 Whitworth Taper
 Pipe Thread (BSPT)
- If required, please indicate special sizes, e.g. R1/8k!
- * Material Code **-W3**
 Steel, zinc/nickel-plated
- Please contact STAUFF for alternative materials and surface finishings.
- * Assembling / Kitting **—**
 Fitting body only
 Fitting body supplied with cutting rings and union nuts **-MS**
 Fitting body supplied with soft-sealing cutting rings and union nuts **-MSV**

Series	Tube OD mm D1	PN bar	Dimensions mm											Weight kg ca. per 100	Ordering Codes ³
			Thread T	D2	D3	i	L	L1 ¹	L2	L3	S1	S2			
LL	4	100	R 1/8 keg.	3	4	8	15	21	11	17	9	10	1,59	FI-TE-04LLRk-W3	
	6	100	R 1/8 keg.	4,5	4,5	8	15	21	9,5	17	9	12	1,34	FI-TE-06LLRk-W3	
	8	100	R 1/8 keg.	6	6	8	17	23	11,5	20	12	14	1,88	FI-TE-08LLRk-W3	
L	6	315	R 1/8 keg.	4	4	8	19	27	12	20	12	14	2,73	FI-TE-06LRk-W3	
	8	315	R 1/4 keg.	6	6	12	21	29	14	26	12	17	3,80	FI-TE-08LRk-W3	
	10	315	R 1/4 keg.	8	7	12	22	30	15	27	14	19	4,70	FI-TE-10LRk-W3	
	12	315	R 1/4 keg.	10	8	15	24	33,5	17	28	17	22	6,02	FI-TE-12LR1/4k-W3	
	12	315	R 3/8 keg.	10	9	12	24	32	17	28	17	22	6,28	FI-TE-12LRk-W3	
	15	315	R 1/2 keg.	12	11	14	28	36	21	34	19	27	11,80	FI-TE-15LRk-W3	
S	18	315	R 1/2 keg.	15	14	14	31	40	23,5	36	24	32	16,30	FI-TE-18LRk-W3	
	6	400	R 1/4 keg.	4	4	12	23	31	16	26	12	17	5,00	FI-TE-06SRk-W3	
	8	400	R 1/4 keg.	5	5	12	24	32	17	27	14	19	6,27	FI-TE-08SRk-W3	
	10	400	R 3/8 keg.	7	7	12	25	34	17,5	28	17	22	8,50	FI-TE-10SRk-W3	
	12	400	R 3/8 keg.	8	8	12	29	38	21,5	28	17	24	11,60	FI-TE-12SRk-W3	
	14	400	R 1/2 keg.	10	10	14	30	40	22	32	19	27	15,47	FI-TE-14SRk-W3	
	16	400	R 1/2 keg.	12	12	14	33	43	24,5	32	24	30	18,90	FI-TE-16SRk-W3	

¹ Approximate dimension in assembled condition.

² Weight excluding cutting rings and union nuts.

³ Standard scope of delivery: Fitting body only.

Male stud acc. to DIN 3852-2 (Form C)

Port acc. to DIN 3852-2 (Form Z)

Suitable liquid / plastic sealant required.

Male threaded studs were designed for female threaded ports in components made of steel. For applications with components made of softer mating materials (e.g. Aluminium), the use of connectors with additionally rolled male threads is recommended.

Please contact STAUFF prior to the assembly for further information.

Connecting Parts

- Cutting Ring
Type **FI-DS** Page 28
- Soft-Sealing Cutting Ring
Type **FI-WDDS** Page 29
- Support Sleeve
Type **FI-VH** Page 31
- STAUFF Form EVO Sealing Ring
Type **FI-FD** Page 32
- Union Nut
Type **FI-M** Page 33
- 37° Flared Tube Fitting Set
Type **FI-AB** Page 37



Male Stud Branch Tee
Type FI-TE-...-Mk ■ Series LL / L / S

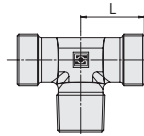
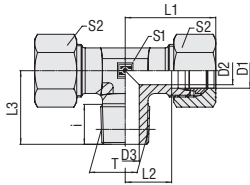

C

Metric Taper Thread

Series	Tube OD mm	PN bar	Dimensions mm												Weight kg ca. per 100	Ordering Codes ³
	D1		Thread T	D2	D3	i	L	L1 ¹	L2	L3	S1	S2				
LL	4	100	M 8 x 1 keg.	3	3,5	8	15	21	11	17	9	10	1,27	FI-TE-04LLMk-W3		
	6	100	M 10 x 1 keg.	4,5	4,5	8	15	21	9,5	17	9	12	1,62	FI-TE-06LLMk-W3		
	8	100	M 10 x 1 keg.	6	6	8	17	23	11,5	20	12	14	2,42	FI-TE-08LLMk-W3		
L	6	315	M 10 x 1 keg.	4	4	8	19	27	12	20	12	14	2,76	FI-TE-06LMk-W3		
	8	315	M 12 x 1,5 keg.	6	6	12	21	29	14	26	12	17	3,45	FI-TE-08LMk-W3		
	10	315	M 14 x 1,5 keg.	8	7	12	22	30	15	27	14	19	4,72	FI-TE-10LMk-W3		
	12	315	M 16 x 1,5 keg.	10	9	12	24	32	17	28	17	22	7,19	FI-TE-12LMk-W3		
	15	315	M 18 x 1,5 keg.	12	11	12	28	36	21	32	19	27	11,86	FI-TE-15LMk-W3		
	18	315	M 22 x 1,5 keg.	15	14	14	31	40	23,5	36	24	32	17,50	FI-TE-18LMk-W3		
S	6	400	M 12 x 1,5 keg.	4	4	12	23	31	16	26	12	17	5,57	FI-TE-06SMk-W3		
	8	400	M 14 x 1,5 keg.	5	5	12	24	32	17	27	14	19	7,54	FI-TE-08SMk-W3		
	10	400	M 16 x 1,5 keg.	7	7	12	25	34	17,5	28	17	22	9,38	FI-TE-10SMk-W3		
	12	400	M 18 x 1,5 keg.	8	8	12	29	38	21,5	28	17	24	10,71	FI-TE-12SMk-W3		
	14	400	M 20 x 1,5 keg.	10	10	14	30	40	22	32	19	27	15,11	FI-TE-14SMk-W3		
	16	400	M 22 x 1,5 keg.	12	12	14	33	43	24,5	32	24	30	20,16	FI-TE-16SMk-W3		

¹ Approx.imate dimension in assembled condition.

² Weight excluding cutting rings and union nuts.

³ Standard scope of delivery: Fitting body only.

Male stud acc. to DIN 3852-1 (Form C)

Port acc. to DIN 3852-1 (Form Z)

Suitable liquid / plastic sealant required.

Male threaded studs were designed for female threaded ports in components made of steel. For applications with components made of softer mating materials (e.g. Aluminium), the use of connectors with additionally rolled male threads is recommended.

Please contact STAUFF prior to the assembly for further information.

Ordering Codes

FI-TE-10*L*Mk*-W3*-MS

* Male Stud Branch Tee	FI-TE
* Outside Tube Diameter D1 (in mm)	-10
* Series	Extra-Light Series LL Light Series L Heavy Series S
* Thread Type	Metric Taper Thread Mk
If required, please indicate special sizes, e.g. M12x1.5 !	
* Material Code	Steel, zinc/nickel-plated -W3
Please contact STAUFF for alternative materials and surface finishings.	
* Assembling / Kitting	Fitting body only — Fitting body supplied with cutting rings and union nuts -MS Fitting body supplied with soft-sealing cutting rings and union nuts -MSV

Connecting Parts

	Cutting Ring Type FI-DS	Page 28
	Soft-Sealing Cutting Ring Type FI-WDDS	Page 29
	Support Sleeve Type FI-VH	Page 31
	STAUFF Form EVO Sealing Ring Type FI-FD	Page 32
	Union Nut Type FI-M	Page 33
	37° Flared Tube Fitting Set Type FI-AB	Page 37



Male Stud Branch Tee
Type FI-TE-...-N • Series LL / L

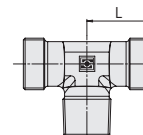
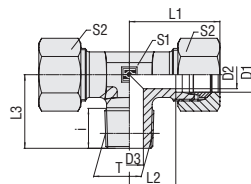

C

Ordering Codes

***FI-TE*-10*L*1/4N*-W3*-MS**

- * Male Stud Branch Tee FI-TE
- * Outside Tube Diameter D1 (in mm) -10
- * Series LL
Extra-Light Series (page 86)
Light Series (page 86)
Heavy Series (page 87) L
S
- * Thread Size 1/4
acc. to dimension table
Please always indicate thread sizes, e.g. 1/4!
- * Thread Type N
NPT Thread
- * Material Code -W3
Steel, zinc/nickel-plated
- * Assembling / Kitting —
Fitting body only
Fitting body supplied with cutting rings and union nuts -MS
Fitting body supplied with soft-sealing cutting rings and union nuts -MSV

NPT-Thread

Series	Tube OD		Dimensions mm	Dimensions											Weight kg ca. per 100	Ordering Codes ³
	mm	bar		Thread	T	D2	D3	i	L	L1 ¹	L2	L3	S1	S2		
LL	4	100	1/8 NPT	3	3	7	15	21	11	17	9	10	1,60	FI-TE-04LL1/8N-W3		
	6	100	1/8 NPT	4,5	4,5	7	15	21	9,5	17	9	12	1,50	FI-TE-06LL1/8N-W3		
	8	100	1/8 NPT	5	5	7	17	23	11,5	20	12	14	2,50	FI-TE-08LL1/8N-W3		
L	6	315	1/8 NPT	4	4	7	19	27	12	20	12	14	3,00	FI-TE-06L1/8N-W3		
	6	315	1/4 NPT	4	4	10	21	29	14	26	12	14	4,40	FI-TE-06L1/4N-W3		
	8	315	1/4 NPT	6	6	10	21	29	14	26	12	17	4,20	FI-TE-08L1/4N-W3		
	10	315	1/4 NPT	7	7	10	22	30	15	27	14	19	5,00	FI-TE-10L1/4N-W3		
	12	315	3/8 NPT	10	10	10,5	24	32	17	28	17	22	6,50	FI-TE-12L3/8N-W3		
	15	315	1/2 NPT	12	12	14	28	36	21	36	19	27	12,10	FI-TE-15L1/2N-W3		
	18	315	1/2 NPT	15	12	14	31	40	23,5	36	24	32	16,30	FI-TE-18L1/2N-W3		
	22	160	3/4 NPT	19	18	14	35	44	27,5	42	27	36	21,80	FI-TE-22L3/4N-W3		
	28	160	1 NPT	24	21	17,5	38	47	30,5	48	36	41	39,00	FI-TE-28L1N-W3		
	35	160	1 1/4 NPT	30	28	18	46	57	35,5	54	41	50	59,40	FI-TE-35L1-1/4N-W3		
42	160	1 1/2 NPT	36	34	18,5	51	63	40	61	50	60	84,10	FI-TE-42L1-1/2N-W3			

¹ Approximate dimension in assembled condition.

² Weight excluding cutting rings and union nuts.

³ Standard scope of delivery: Fitting body only.

Male stud acc. to ANSI/ASME B1.20.1-1983

Port acc. to ANSI/ASME B1.20.1-1983

Suitable liquid / plastic sealant required.

Male threaded studs were designed for female threaded ports in components made of steel. For applications with components made of softer mating materials (e.g. Aluminium), the use of connectors with additionally rolled male threads is recommended.

Please contact STAUFF prior to the assembly for further information.

Connecting Parts

-  Cutting Ring
Type **FI-DS** Page 28
-  Soft-Sealing Cutting Ring
Type **FI-WDDS** Page 29
-  Support Sleeve
Type **FI-VH** Page 31
-  STAUFF Form EVO Sealing Ring
Type **FI-FD** Page 32
-  Union Nut
Type **FI-M** Page 33
-  37° Flared Tube Fitting Set
Type **FI-AB** Page 37



Male Stud Branch Tee
Type FI-TE-...-N • Series S

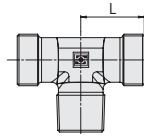
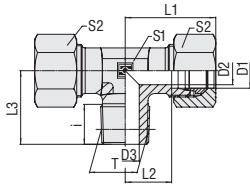

C

NPT Thread

Series	Tube OD mm	PN bar	Dimensions mm										Weight kg.ca. per 100	Ordering Codes ³
			Thread	T	D2	D3	i	L	L1 ¹	L2	L3	S1		
S	6	630	1/4 NPT	4	4	10	23	31	16	26	12	17	5,50	FI-TE-06S1/4N-W3
	8	630	1/4 NPT	5	5	10	24	32	17	27	14	19	6,80	FI-TE-08S1/4N-W3
	10	630	3/8 NPT	7	7	10,5	25	34	17,5	28	17	22	8,80	FI-TE-10S3/8N-W3
	12	630	3/8 NPT	8	8	10,5	29	38	21,5	28	17	24	11,10	FI-TE-12S3/8N-W3
	14	630	1/2 NPT	10	10	14	30	40	22	34	19	27	15,10	FI-TE-14S1/2N-W3
	16	630	1/2 NPT	12	12	14	33	43	24,5	36	24	30	19,00	FI-TE-16S1/2N-W3
	20	400	3/4 NPT	16	16	14	37	48	26,5	42	27	36	28,20	FI-TE-20S3/4N-W3
	25	400	1 NPT	20	20	17,5	42	54	30	48	36	46	50,40	FI-TE-25S1N-W3
	30	400	1 1/4 NPT	25	25	18	49	62	35,5	54	41	50	78,20	FI-TE-30S1-1/4N-W3
	38	400	1 1/2 NPT	32	32	18,5	57	72	41	61	50	60	113,30	FI-TE-38S1-1/2N-W3

¹ Approximate dimension in assembled condition.

² Weight excluding cutting rings and union nuts.

³ Standard scope of delivery: Fitting body only.

Male stud acc. to ANSI/ASME B1.20.1-1983

Port acc. to ANSI/ASME B1.20.1-1983

Suitable liquid / plastic sealant required.

Male threaded studs were designed for female threaded ports in components made of steel. For applications with components made of softer mating materials (e.g. Aluminium), the use of connectors with additionally rolled male threads is recommended.

Please contact STAUFF prior to the assembly for further information.

Ordering Codes

***FI-TE*-10*S*3/8N*-W3*-MS**

* Male Stud Branch Tee		FI-TE
* Outside Tube Diameter D1 (in mm)		-10
* Series	Extra-Light Series (page 86) Light Series (page 86) Heavy Series (page 87)	LL L S
* Thread Size	acc. to dimension table	3/8
Please always indicate thread sizes, e.g. 1/4!		
* Thread Type	NPT Thread	N
* Material Code	Steel, zinc/nickel-plated	-W3
Please contact STAUFF for alternative materials and surface finishings.		
* Assembling / Kitting	Fitting body only	—
	Fitting body supplied with cutting rings and union nuts	-MS
	Fitting body supplied with soft-sealing cutting rings and union nuts	-MSV

Connecting Parts

	Cutting Ring Type FI-DS	Page 28
	Soft-Sealing Cutting Ring Type FI-WDDS	Page 29
	Support Sleeve Type FI-VH	Page 31
	STAUFF Form EVO Sealing Ring Type FI-FD	Page 32
	Union Nut Type FI-M	Page 33
	37° Flared Tube Fitting Set Type FI-AB	Page 37



Male Stud Barrel Tee
Type FI-LE-...-R • Series L / S

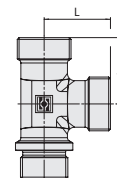
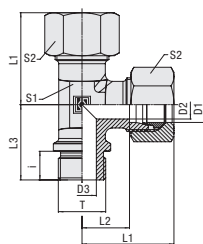

C

Ordering Codes

***FI-LE*-22*L*R*-W3*-MS**

- * Male Stud Barrel Tee FI-LE
- * Outside Tube Diameter D1 (in mm) -22
- * Series L
S
 - Light Series
 - Heavy Series
- * Thread Type R
 - Whitworth Parallel Pipe Thread (BSPP)
- If required, please indicate special sizes, e.g. R1/2!
- * Material Code -W3
 - Steel, zinc/nickel-plated
- Please contact STAUFF for alternative materials and surface finishings.
- * Assembling / Kitting —
 - Fitting body only
 - Fitting body supplied with cutting rings and union nuts -MS
 - Fitting body supplied with soft-sealing cutting rings and union nuts -MSV

Whitworth Parallel Pipe Thread (BSPP)

Metallic Sealing Edge

Series	Tube OD mm D1	PN bar	Dimensions mm											Torque N-m Thread T	Weight kg ca. per 100	Ordering Codes ³
			Thread T	D2	D3	i	L	L1 ¹	L2	L3	S1	S2				
L	22	160	G 3/4	18	18	16	35	44	27,5	42	27	36	180	25,01	FI-LE-22LR-W3	
	28	160	G 1	23	23	18	38	47	30,5	48	36	41	330	40,60	FI-LE-28LR-W3	
	35	160	G 1 1/4	30	30	20	45	56	34,5	54	41	50	540	61,96	FI-LE-35LR-W3	
	42	160	G 1 1/2	36	36	22	51	63	40	61	50	60	630	100,41	FI-LE-42LR-W3	
S	20	400	G 3/4	16	16	16	37	48	26,5	42	27	36	270	31,72	FI-LE-20SR-W3	
	25	250	G 1	20	20	18	42	54	30	48	36	46	340	54,62	FI-LE-25SR-W3	
	30	160	G 1 1/4	25	25	20	49	62	35,5	54	41	50	540	52,00	FI-LE-30SR-W3	
	38	160	G 1 1/2	32	32	22	57	72	41	61	50	60	700	134,44	FI-LE-38SR-W3	

¹ Approx.imate dimension in assembled condition.

² Weight excluding cutting rings and union nuts.

³ Standard scope of delivery: Fitting body only.

Male stud acc. to DIN 3852-2 (Form B) / ISO 1179-4 (Type B)
Port acc. to DIN 3852-2 (Form X) / ISO 1179-1

Torque recommendations for Steel mating material.

Male threaded studs were designed for female threaded ports in components made of steel. For applications with components made of softer mating materials (e.g. Aluminium), the use of connectors with additionally rolled male threads is recommended.

Please contact STAUFF prior to the assembly for further information.

Connecting Parts

- Cutting Ring
Type **FI-DS** Page 28
- Soft-Sealing Cutting Ring
Type **FI-WDDS** Page 29
- Support Sleeve
Type **FI-VH** Page 31
- STAUFF Form EVO Sealing Ring
Type **FI-FD** Page 32
- Union Nut
Type **FI-M** Page 33
- 37° Flared Tube Fitting Set
Type **FI-AB** Page 37



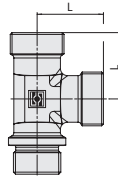
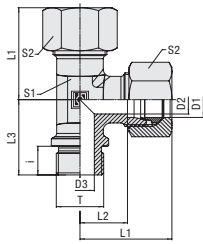

Male Stud Barrel Tee
Type FI-LE-...-M • Series L / S



C

Metallic Sealing Edge

Metric Parallel Thread

Series	Tube OD mm	PN bar	Dimensions mm											Torque N-m	Weight kg ca. per 100	Ordering Codes ³
			Thread	T	D2	D3	i	L	L1 ¹	L2	L3	S1	S2			
L	22	160	M 26 x 1,5	18	18	16	35	44	27,5	42	27	36	190	25,01	FI-LE-22LM-W3	
	28	160	M 33 x 2	23	23	18	38	47	30,5	48	27	41	340	40,60	FI-LE-28LM-W3	
	35	160	M 42 x 2	30	30	20	45	56	34,5	54	41	50	500	61,96	FI-LE-35LM-W3	
	42	160	M 48 x 2	36	36	22	51	63	40	61	50	60	630	100,41	FI-LE-42LM-W3	
S	20	400	M 27 x 2	16	16	16	37	48	26,5	42	27	36	270	31,72	FI-LE-20SM-W3	
	25	250	M 33 x 2	20	20	18	42	54	30	48	36	46	410	54,62	FI-LE-25SM-W3	
	30	160	M 42 x 2	25	25	20	49	62	35,5	54	41	50	540	52,00	FI-LE-30SM-W3	
	38	160	M 48 x 2	32	32	22	57	72	41	61	50	60	700	134,44	FI-LE-38SM-W3	

¹ Approx.imate dimension in assembled condition.

² Weight excluding cutting rings and union nuts.

³ Standard scope of delivery: Fitting body only.

Male stud acc. to DIN 3852-1 (Form B) / ISO 9974-3 (Type B)
Port acc. to DIN 3852-1 (Form X) / ISO 9974-1

Torque recommendations for Steel mating material.

Male threaded studs were designed for female threaded ports in components made of steel. For applications with components made of softer mating materials (e.g. Aluminium), the use of connectors with additionally rolled male threads is recommended.

Please contact STAUFF prior to the assembly for further information.

Ordering Codes

FI-LE-22*L*M*-W3*-MS

* Male Stud Barrel Tee		FI-LE
* Outside Tube Diameter D1 (in mm)		-22
* Series	Light Series	L
	Heavy Series	S
* Thread Type	Metric Parallel Thread	M
If required, please indicate special sizes, e.g. M27x2!		
* Material Code	Steel, zinc/nickel-plated	-W3
Please contact STAUFF for alternative materials and surface finishings.		
* Assembling / Kitting	Fitting body only	—
	Fitting body supplied with cutting rings and union nuts	-MS
	Fitting body supplied with soft-sealing cutting rings and union nuts	-MSV

Connecting Parts

	Cutting Ring Type FI-DS	Page 28
	Soft-Sealing Cutting Ring Type FI-WDDS	Page 29
	Support Sleeve Type FI-VH	Page 31
	STAUFF Form EVO Sealing Ring Type FI-FD	Page 32
	Union Nut Type FI-M	Page 33
	37° Flared Tube Fitting Set Type FI-AB	Page 37



Male Stud Barrel Tee
Type FI-LE-...-Rk ▪ Series LL / L / S

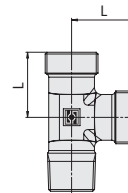
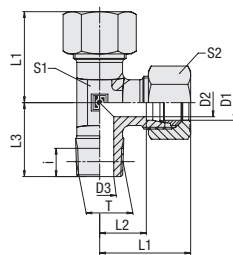

C

Whitworth Taper Pipe Thread (BSPT)

Ordering Codes

***FI-LE*-10*L*Rk*-W3*-MS**

- * Male Stud Barrel Tee **FI-LE**
- * Outside Tube Diameter D1 (in mm) **-10**
- * Series **LL**
 Extra-Light Series **L**
 Light Series **S**
 Heavy Series
- * Thread Type **Rk**
 Whitworth Taper Pipe Thread (BSPT)
- If required, please indicate special sizes, e.g. R1/8k!
- * Material Code **-W3**
 Steel, zinc/nickel-plated
- Please contact STAUFF for alternative materials and surface finishings.
- * Assembling / Kitting **—**
 Fitting body only
- Fitting body supplied with cutting rings and union nuts **-MS**
- Fitting body supplied with soft-sealing cutting rings and union nuts **-MSV**

Series	Tube OD mm D1	PN bar	Dimensions mm											Weight kg ca. per 100	Ordering Codes ³
			Thread T	D2	D3	i	L	L1 ¹	L2	L3	S1	S2			
LL	4	100	R 1/8 keg.	3	4	8	15	21	11	17	9	10	1,50	FI-LE-04LLRk-W3	
	6	100	R 1/8 keg.	4,5	5	8	16	21	9,5	17	9	12	1,60	FI-LE-06LLRk-W3	
	8	100	R 1/8 keg.	6	6	8	17	23	11,5	20	12	14	2,42	FI-LE-08LLRk-W3	
L	6	315	R 1/8 keg.	4	4	8	19	27	12	20	12	14	3,43	FI-LE-06LRk-W3	
	8	315	R 1/4 keg.	6	6	12	21	29	14	26	12	17	3,79	FI-LE-08LRk-W3	
	10	315	R 1/4 keg.	8	7	12	22	30	15	27	14	19	5,20	FI-LE-10LRk-W3	
	12	315	R 3/8 keg.	10	9	12	24	32	17	28	17	22	6,34	FI-LE-12LRk-W3	
	15	315	R 1/2 keg.	12	11	14	28	36	21	34	19	27	11,50	FI-LE-15LRk-W3	
	18	315	R 1/2 keg.	15	14	14	31	40	23,5	36	24	32	14,48	FI-LE-18LRk-W3	
S	6	400	R 1/4 keg.	4	4	12	23	31	16	26	12	17	5,03	FI-LE-06SRk-W3	
	8	400	R 1/4 keg.	5	5	12	24	32	17	27	14	19	6,41	FI-LE-08SRk-W3	
	10	400	R 3/8 keg.	7	7	12	25	34	17,5	28	17	22	8,33	FI-LE-10SRk-W3	
	12	400	R 3/8 keg.	8	8	12	29	38	21,5	28	17	24	10,46	FI-LE-12SRk-W3	
	14	400	R 1/2 keg.	10	10	14	30	40	22	32	19	27	13,91	FI-LE-14SRk-W3	
	16	400	R 1/2 keg.	12	12	14	33	43	24,5	32	24	30	17,66	FI-LE-16SRk-W3	

¹ Approx.imate dimension in assembled condition.

² Weight excluding cutting rings and union nuts.

³ Standard scope of delivery: Fitting body only.

Male stud acc. to DIN 3852-2 (Form C)

Port acc. to DIN 3852-2 (Form Z)

Suitable liquid / plastic sealant required.

Male threaded studs were designed for female threaded ports in components made of steel. For applications with components made of softer mating materials (e.g. Aluminium), the use of connectors with additionally rolled male threads is recommended.

Please contact STAUFF prior to the assembly for further information.

Connecting Parts

- Cutting Ring
Type **FI-DS** Page 28
- Soft-Sealing Cutting Ring
Type **FI-WDDS** Page 29
- Support Sleeve
Type **FI-VH** Page 31
- STAUFF Form EVO Sealing Ring
Type **FI-FD** Page 32
- Union Nut
Type **FI-M** Page 33
- 37° Flared Tube Fitting Set
Type **FI-AB** Page 37

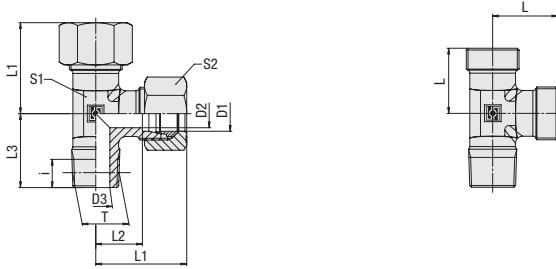

Male Stud Barrel Tee
Type FI-LE-...-Mk ■ Series LL / L / S

C
Metric Taper Thread

Series	Tube OD mm	PN bar	Dimensions mm											Weight kg ca. per 100	Ordering Codes ³
			Thread T	D2	D3	i	L	L1 ¹	L2	L3	S1	S2			
LL	4	100	M 8 x 1 keg.	3	3,5	8	15	21	11	17	9	10	1,50	FI-LE-04LLMk-W3	
	6	100	M 10 x 1 keg.	4,5	4,5	8	15	21	9,5	17	9	12	1,62	FI-LE-06LLMk-W3	
	8	100	M 10 x 1 keg.	6	6	8	17	23	11,5	20	12	14	2,42	FI-LE-08LLMk-W3	
L	6	315	M 10 x 1 keg.	4	4	8	19	27	12	20	12	14	3,43	FI-LE-06LMk-W3	
	8	315	M 12 x 1,5 keg.	6	6	12	21	29	14	26	12	17	4,24	FI-LE-08LMk-W3	
	10	315	M 14 x 1,5 keg.	8	7	12	22	30	15	27	14	19	5,57	FI-LE-10LMk-W3	
	12	315	M 16 x 1,5 keg.	10	9	12	24	32	17	28	17	22	7,19	FI-LE-12LMk-W3	
	15	315	M 18 x 1,5 keg.	12	11	12	28	36	21	32	19	27	11,86	FI-LE-15LMk-W3	
	18	315	M 22 x 1,5 keg.	15	14	14	31	40	23,5	36	24	32	17,50	FI-LE-18LMk-W3	
S	6	400	M 12 x 1,5 keg.	4	4	12	23	31	16	26	12	17	5,57	FI-LE-06SMk-W3	
	8	400	M 14 x 1,5 keg.	5	5	12	24	32	17	27	14	19	7,54	FI-LE-08SMk-W3	
	10	400	M 16 x 1,5 keg.	7	7	12	25	34	17,5	28	17	22	8,37	FI-LE-10SMk-W3	
	12	400	M 18 x 1,5 keg.	8	8	12	29	38	21,5	28	17	24	12,07	FI-LE-12SMk-W3	
	14	400	M 20 x 1,5 keg.	10	10	14	30	40	22	32	19	27	15,11	FI-LE-14SMk-W3	
	16	400	M 22 x 1,5 keg.	12	12	14	33	43	24,5	32	24	30	20,16	FI-LE-16SMk-W3	

¹ Approx.imate dimension in assembled condition.

² Weight excluding cutting rings and union nuts.

³ Standard scope of delivery: Fitting body only.

Male stud acc. to DIN 3852-1 (Form C)

Port acc. to DIN 3852-1 (Form Z)

Suitable liquid / plastic sealant required.

Male threaded studs were designed for female threaded ports in components made of steel. For applications with components made of softer mating materials (e.g. Aluminium), the use of connectors with additionally rolled male threads is recommended.

Please contact STAUFF prior to the assembly for further information.

Ordering Codes
***FI-LE*-10*L*Mk*-W3*-MS**

* Male Stud Barrel Tee	FI-LE
* Outside Tube Diameter D1 (in mm)	-10
* Series	Extra-Light Series LL Light Series L Heavy Series S
* Thread Type	Metric Taper Thread Mk
If required, please indicate special sizes, e.g. M12x1.5 !	
* Material Code	Steel, zinc/nickel-plated -W3
Please contact STAUFF for alternative materials and surface finishings.	
* Assembling / Kitting	Fitting body only — Fitting body supplied with cutting rings and union nuts -MS Fitting body supplied with soft-sealing cutting rings and union nuts -MSV

Connecting Parts

	Cutting Ring Type FI-DS	Page 28
	Soft-Sealing Cutting Ring Type FI-WDDS	Page 29
	Support Sleeve Type FI-VH	Page 31
	STAUFF Form EVO Sealing Ring Type FI-FD	Page 32
	Union Nut Type FI-M	Page 33
	37° Flared Tube Fitting Set Type FI-AB	Page 37



Male Stud Barrel Tee
Type FI-LE-...-N • Series LL / L

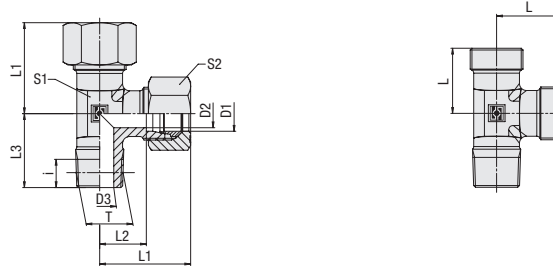

C

Ordering Codes

***FI-LE*-10*L*1/4N*-W3*-MS**

- * Male Stud Barrel Tee **FI-LE**
- * Outside Tube Diameter D1 (in mm) **-10**
- * Series **LL**
 Extra-Light Series (page 92)
 Light Series (page 92)
 Heavy Series (page 93)
L
S
- * Thread Size **1/4**
 acc. to dimension table
 Please always indicate thread sizes, e.g. 1/4!
- * Thread Type **N**
 NPT Thread
- * Material Code **-W3**
 Steel, zinc/nickel-plated
 Please contact STAUFF for alternative materials and surface finishings.
- * Assembling / Kitting **—**
 Fitting body only
 Fitting body supplied with cutting rings and union nuts **-MS**
 Fitting body supplied with soft-sealing cutting rings and union nuts **-MSV**

NPT-Thread

Series	Tube OD		PN	Dimensions										Weight kg ca. per 100	Ordering Codes ³
	mm	bar		mm	Thread	T	D2	D3	i	L	L1 ¹	L2	L3		
LL	4	100	1/8 NPT	3	3	7	15	21	11	15	9	10	1,51	FI-LE-04LL1/8N-W3	
	6	100	1/8 NPT	4,5	4,5	7	15	21	9,5	15	10	12	1,62	FI-LE-06LL1/8N-W3	
	8	100	1/8 NPT	5	5	7	17	23	11,5	20	12	14	3,30	FI-LE-08LL1/8N-W3	
L	6	315	1/8 NPT	4	4	7	19	27	12	20	12	14	1,30	FI-LE-06L1/8N-W3	
	8	315	1/4 NPT	6	6	10	21	29	14	26	12	17	4,24	FI-LE-08L1/4N-W3	
	10	315	1/4 NPT	7	7	10	22	30	15	27	14	19	5,57	FI-LE-10L1/4N-W3	
	12	315	3/8 NPT	10	10	10,5	24	32	17	28	17	22	7,19	FI-LE-12L3/8N-W3	
	15	315	1/2 NPT	12	12	14	28	36	21	34	19	27	11,86	FI-LE-15L1/2N-W3	
	18	315	1/2 NPT	14	14	14	31	40	23,5	36	24	32	17,50	FI-LE-18L1/2N-W3	
	22	160	3/4 NPT	18	18	14	35	44	27,5	42	27	36	27,60	FI-LE-22L3/4N-W3	
	28	160	1 NPT	24	24	17,5	38	47	30,5	48	36	41	43,00	FI-LE-28L1N-W3	
	35	160	1 1/4 NPT	30	30	18	46	57	35,5	54	41	50	63,50	FI-LE-35L1-1/4N-W3	
	42	160	1 1/2 NPT	36	36	18	51	63	40	61	50	60	110,00	FI-LE-42L1-1/2N-W3	

¹ Approximate dimension in assembled condition.

² Weight excluding cutting rings and union nuts.

³ Standard scope of delivery: Fitting body only.

Male stud acc. to ANSI/ASME B1.20.1-1983

Port acc. to ANSI/ASME B1.20.1-1983

Suitable liquid / plastic sealant required.

Male threaded studs were designed for female threaded ports in components made of steel. For applications with components made of softer mating materials (e.g. Aluminium), the use of connectors with additionally rolled male threads is recommended.

Please contact STAUFF prior to the assembly for further information.

Connecting Parts

-  Cutting Ring
Type **FI-DS** Page 28
-  Soft-Sealing Cutting Ring
Type **FI-WDDS** Page 29
-  Support Sleeve
Type **FI-VH** Page 31
-  STAUFF Form EVO Sealing Ring
Type **FI-FD** Page 32
-  Union Nut
Type **FI-M** Page 33
-  37° Flared Tube Fitting Set
Type **FI-AB** Page 37



Male Stud Barrel Tee
Type FI-LE-...-N • Series S

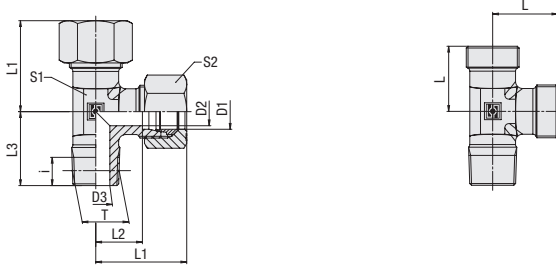

C

NPT Thread

Series	Tube OD mm	PN bar	Dimensions mm										Weight kg.ca. per 100	Ordering Codes ³
			Thread	T	D2	D3	i	L	L1 ¹	L2	L3	S1		
S	6	630	1/4 NPT	4	4	10	23	31	16	26	12	17	5,57	FI-LE-06S1/4N-W3
	8	630	1/4 NPT	5	5	10	24	32	17	27	14	19	7,54	FI-LE-08S1/4N-W3
	10	630	3/8 NPT	7	7	10,5	25	34	17,5	28	17	22	10,50	FI-LE-10S3/8N-W3
	12	630	3/8 NPT	8	8	10,5	29	38	21,5	28	17	24	12,07	FI-LE-12S3/8N-W3
	14	630	1/2 NPT	10	10	14	30	40	22	34	19	27	15,11	FI-LE-14S1/2N-W3
	16	630	1/2 NPT	12	12	14	33	43	24,5	36	24	30	20,16	FI-LE-16S1/2N-W3
	20	400	3/4 NPT	16	16	14	37	48	26,5	42	27	36	35,00	FI-LE-20S3/4N-W3
	25	400	1 NPT	20	20	17,5	42	54	30	48	36	46	56,00	FI-LE-25S1N-W3
	30	400	1 1/4 NPT	25	32	18	49	62	35,5	54	41	50	74,20	FI-LE-30S1-1/4N-W3
	38	400	1 1/2 NPT	32	32	18	57	72	41	61	50	60	145,00	FI-LE-38S1-1/2N-W3

¹ Approximate dimension in assembled condition.

² Weight excluding cutting rings and union nuts.

³ Standard scope of delivery: Fitting body only.

Male stud acc. to ANSI/ASME B1.20.1-1983

Port acc. to ANSI/ASME B1.20.1-1983

Suitable liquid / plastic sealant required.

Male threaded studs were designed for female threaded ports in components made of steel. For applications with components made of softer mating materials (e.g. Aluminium), the use of connectors with additionally rolled male threads is recommended.

Please contact STAUFF prior to the assembly for further information.

Ordering Codes

***FI-LE*-10*S*3/8N*-W3*-MS**

* Male Stud Barrel Tee	FI-LE
* Outside Tube Diameter D1 (in mm)	-10
* Series	Extra-Light Series (page 92) LL Light Series (page 92) L Heavy Series (page 93) S
* Thread Size	acc. to dimension table 3/8
Please always indicate thread sizes, e.g. 1/4!	
* Thread Type	NPT Thread N
* Material Code	Steel, zinc/nickel-plated -W3
Please contact STAUFF for alternative materials and surface finishings.	
* Assembling / Kitting	Fitting body only —
	Fitting body supplied with cutting rings and union nuts -MS
	Fitting body supplied with soft-sealing cutting rings and union nuts -MSV

Connecting Parts

	Cutting Ring Type FI-DS	Page 28
	Soft-Sealing Cutting Ring Type FI-WDDS	Page 29
	Support Sleeve Type FI-VH	Page 31
	STAUFF Form EVO Sealing Ring Type FI-FD	Page 32
	Union Nut Type FI-M	Page 33
	37° Flared Tube Fitting Set Type FI-AB	Page 37



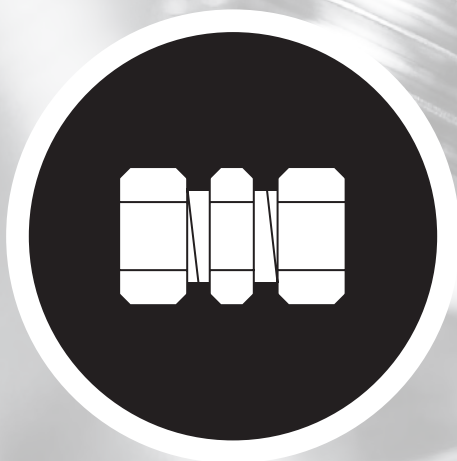



Straight Union

FI-G

96



Straight Reducer

FI-G

97



Equal Elbow

FI-W

99



Equal Tee

FI-T

100



Tee Reducer

FI-T

101



Equal Cross

FI-K

104

D



Straight Union
Type FI-G ▪ Series LL / L / S

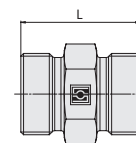
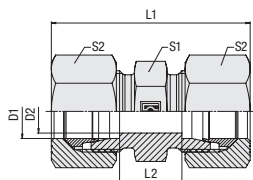

D

Ordering Codes

***FI-G*-10*L*-W3*-MS**

- * Straight Union **FI-G**
- * Outside Tube Diameter D1 (in mm) **-10**
- * Series **LL**
 Extra-Light Series **L**
 Light Series **S**
 Heavy Series
- * Material Code **-W3**
 Steel, zinc/nickel-plated
- Please contact STAUFF for alternative materials and surface finishings.
- * Assembling / Kitting **—**
 Fitting body only
- Fitting body supplied with cutting rings and union nuts **-MS**
- Fitting body supplied with soft-sealing cutting rings and union nuts **-MSV**

Series	Tube OD	PN	Dimensions						Weight kg ca. per 100	Ordering Codes ³	
	mm D1		mm D2	L	L1 ¹	L2	S1	S2			
LL	4	100	3	20	31	12	9	10	0,53	FI-G-04LL-W3	
	6	100	4,5	20	32	9	11	12	0,79	FI-G-06LL-W3	
	8	100	6	23	35	12	12	14	1,05	FI-G-08LL-W3	
	10	100	8	23	35	12	14	17	1,29	FI-G-10LL-W3	
	12	100	10	23	35	11	17	19	1,83	FI-G-12LL-W3	
L	6	500	4	24	39	10	12	14	1,44	FI-G-06L-W3	
	8	500	6	25	40	11	14	17	1,90	FI-G-08L-W3	
	10	500	8	27	42	13	17	19	2,60	FI-G-10L-W3	
	12	400	10	28	43	14	19	22	2,67	FI-G-12L-W3	
	15	400	12	30	46	16	24	27	4,81	FI-G-15L-W3	
	18	400	15	31	48	16	27	32	6,65	FI-G-18L-W3	
	22	250	19	35	52	20	32	36	8,94	FI-G-22L-W3	
	28	250	24	36	54	21	41	41	13,90	FI-G-28L-W3	
	35	250	30	41	63	20	46	50	21,11	FI-G-35L-W3	
	42	250	36	43	66	21	55	60	29,26	FI-G-42L-W3	
	S	6	800	4	30	45	16	14	17	2,52	FI-G-06S-W3
		8	800	5	32	47	18	17	19	3,67	FI-G-08S-W3
10		800	7	32	49	17	19	22	4,23	FI-G-10S-W3	
12		630	8	34	51	19	22	24	5,88	FI-G-12S-W3	
14		630	10	38	57	22	24	27	7,52	FI-G-14S-W3	
16		630	12	38	57	21	27	30	9,20	FI-G-16S-W3	
20		420	16	44	66	23	32	36	14,27	FI-G-20S-W3	
25		420	20	50	74	26	41	46	24,99	FI-G-25S-W3	
30		420	25	54	80	27	46	50	33,08	FI-G-30S-W3	
38		420	32	61	90	29	55	60	53,80	FI-G-38S-W3	

Connecting Parts

- Cutting Ring
Type **FI-DS** Page 28
- Soft-Sealing Cutting Ring
Type **FI-WDDS** Page 29
- Support Sleeve
Type **FI-VH** Page 31
- STAUFF Form EVO Sealing Ring
Type **FI-FD** Page 32
- Union Nut
Type **FI-M** Page 33
- 37° Flared Tube Fitting Set
Type **FI-AB** Page 37

¹ Approximate dimension in assembled condition.

² Weight excluding cutting rings and union nuts.

³ Standard scope of delivery: Fitting body only.



Straight Reducer
Type FI-G ▪ Series LL / L

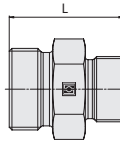
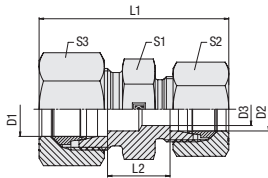

D

Series	Tube OD mm		PN bar	Dimensions mm							Weight kg ca. per 100	Ordering Codes ³
	D1	D2		D3	L	L1 ¹	L2	S1	S2	S3		
LL	6	4	100	3	20	32	10,5	11	10	12	0,70	FI-G-06/04LL-W3
	8	4	100	3	22	34	12,5	12	10	14	1,00	FI-G-08/04LL-W3
	8	6	100	4	22	34	11	12	12	14	0,99	FI-G-08/06LL-W3
L	8	6	500	4	25	40	11	14	14	17	1,61	FI-G-08/06L-W3
	10	6	500	4	26	41	12	17	14	19	1,99	FI-G-10/06L-W3
	10	8	500	6	26	41	12	17	17	19	2,21	FI-G-10/08L-W3
	12	6	400	4	27	42	13	19	14	22	2,47	FI-G-12/06L-W3
	12	8	400	6	27	42	13	19	17	22	2,63	FI-G-12/08L-W3
	12	10	400	8	28	43	14	19	19	22	2,81	FI-G-12/10L-W3
	15	6	400	4	29	47	15	24	14	27	4,55	FI-G-15/06L-W3
	15	8	400	6	29	47	15	24	17	27	4,56	FI-G-15/08L-W3
	15	10	400	8	29	45	15	24	19	27	4,36	FI-G-15/10L-W3
	15	12	400	10	29	45	15	24	22	27	4,42	FI-G-15/12L-W3
	18	8	400	6	30	48	15,5	27	17	32	6,25	FI-G-18/08L-W3
	18	10	400	8	30	46	15,5	27	19	32	6,01	FI-G-18/10L-W3
	18	12	400	10	30	46	15,5	27	22	32	5,56	FI-G-18/12L-W3
	18	15	400	12	31	48	16,5	27	27	32	6,73	FI-G-18/15L-W3
	22	8	250	6	31	50	16,5	32	17	36	7,56	FI-G-22/08L-W3
	22	10	250	8	32	51	17,5	32	19	36	1,36	FI-G-22/10L-W3
	22	12	250	10	32	48	17,5	32	22	36	7,99	FI-G-22/12L-W3
	22	15	250	12	33	50	18,5	32	27	36	8,37	FI-G-22/15L-W3
	22	18	250	15	33	50	18	32	32	36	8,76	FI-G-22/18L-W3
	28	10	250	8	33	53	18,5	41	19	41	12,12	FI-G-28/10L-W3
	28	12	250	10	33,5	54	19	41	22	41	13,02	FI-G-28/12L-W3
	28	15	250	12	34	55	19,5	41	27	41	13,12	FI-G-28/15L-W3
	28	18	250	15	34	52	19	41	32	41	13,29	FI-G-28/18L-W3
28	22	250	19	36	54	21	41	36	41	13,61	FI-G-28/22L-W3	
35	18	250	15	37	60	19	46	32	50	19,74	FI-G-35/18L-W3	
35	22	250	19	39	59	21	46	36	50	19,99	FI-G-35/22L-W3	
35	28	250	24	39	59	21	46	41	50	19,71	FI-G-35/28L-W3	

¹ Approx.imate dimension in assembled condition.

² Weight excluding cutting rings and union nuts.

³ Standard scope of delivery: Fitting body only.

Ordering Codes

***FI-G*-10/*08*L*-W3*-MS**

- * Straight Reducer FI-G
- * Outside Tube Diameter D1 (in mm) -10
- * Outside Tube Diameter D2 (in mm) 08
- * Series LL
 Extra-Light Series (page 97) LL
 Light Series (pages 97/98) L
 Heavy Series (page 98) S
- * Material Code -W3
 Steel, zinc/nickel-plated
- Please contact STAUFF for alternative materials and surface finishings.
- * Assembling / Kitting —
 Fitting body only
- MS
 Fitting body supplied with cutting rings and union nuts
- MSV
 Fitting body supplied with soft-sealing cutting rings and union nuts

Connecting Parts

-  Cutting Ring
Type **FI-DS** Page 28
-  Soft-Sealing Cutting Ring
Type **FI-WDDS** Page 29
-  Support Sleeve
Type **FI-VH** Page 31
-  STAUFF Form EVO Sealing Ring
Type **FI-FD** Page 32
-  Union Nut
Type **FI-M** Page 33
-  37° Flared Tube Fitting Set
Type **FI-AB** Page 37



Straight Reducer Type FI-G ▪ Series L / S

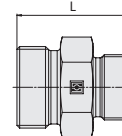
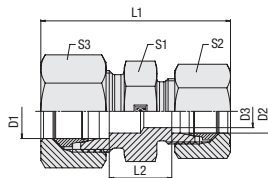

D

Ordering Codes

***FI-G*-10/*08*L*-W3*-MS**

- * Straight Reducer **FI-G**
- * Outside Tube Diameter D1 (in mm) **-10**
- * Outside Tube Diameter D2 (in mm) **08**
- * Series **LL**
L
S
 - Extra-Light Series (page 97)
 - Light Series (pages 97/98)
 - Heavy Series (page 98)
- * Material Code **-W3**
 - Steel, zinc/nickel-plated
- Please contact STAUFF for alternative materials and surface finishings.
- * Assembling / Kitting **—**
 - Fitting body only
 - Fitting body supplied with cutting rings and union nuts **-MS**
 - Fitting body supplied with soft-sealing cutting rings and union nuts **-MSV**

Connecting Parts

- Cutting Ring
Type **FI-DS** Page 28
- Soft-Sealing Cutting Ring
Type **FI-WDDS** Page 29
- Support Sleeve
Type **FI-VH** Page 31
- STAUFF Form EVO Sealing Ring
Type **FI-FD** Page 32
- Union Nut
Type **FI-M** Page 33
- 37° Flared Tube Fitting Set
Type **FI-AB** Page 37

Series	Tube OD mm		PN bar	Dimensions mm							Weight kg ca. per 100	Ordering Codes ³
	D1	D2		D3	L	L1 ¹	L2	S1	S2	S3		
L	42	18	250	15	37,5	60	19	55	32	60	29,95	FI-G-42/18L-W3
	42	22	250	19	39,5	63	21	55	36	60	22,68	FI-G-42/22L-W3
	42	28	250	24	39,5	66	21	55	41	60	27,03	FI-G-42/28L-W3
	42	35	250	30	42,5	66	21	55	50	60	29,78	FI-G-42/35L-W3
S	8	6	800	4	32	47	18	17	17	19	3,46	FI-G-08/06S-W3
	10	6	800	4	32	48	17,5	19	17	22	4,40	FI-G-10/06S-W3
	10	8	800	5	32	48	17,5	19	19	22	4,26	FI-G-10/08S-W3
	12	6	630	4	34	50	19,5	22	17	24	5,56	FI-G-12/06S-W3
	12	8	630	5	34	50	19,5	22	19	24	4,03	FI-G-12/08S-W3
	12	10	630	7	34	51	19	22	22	24	5,86	FI-G-12/10S-W3
	14	10	630	7	36	54	20,5	24	22	27	7,16	FI-G-14/10S-W3
	14	12	630	8	36	54	20,5	24	24	27	7,34	FI-G-14/12S-W3
	16	6	630	35,5	35,5	55	20	27	17	30	7,78	FI-G-16/06S-W3
	16	8	630	5	35,5	55	20	27	19	30	7,86	FI-G-16/08S-W3
	16	10	630	7	36	54	20	27	22	30	7,95	FI-G-16/10S-W3
	16	12	630	8	36	54	20	27	24	30	9,32	FI-G-16/12S-W3
	16	14	630	10	38	57	21,5	27	27	30	8,95	FI-G-16/14S-W3
	20	10	420	7	40	60	22	32	22	36	12,93	FI-G-20/10S-W3
	20	12	420	8	40	60	22	32	24	36	13,19	FI-G-20/12S-W3
	20	16	420	12	42	63	23	32	30	36	13,38	FI-G-20/16S-W3
	25	12	420	8	45	68	25,5	41	24	46	23,92	FI-G-25/12S-W3
	25	16	420	12	46	68	25,5	41	30	46	22,87	FI-G-25/16S-W3
	25	20	420	16	48	71	25,5	41	36	46	23,66	FI-G-25/20S-W3
	30	12	420	8	46	71	25	46	24	50	29,2	FI-G-30/12S-W3
	30	16	420	12	48	74	26	46	30	50	29,61	FI-G-30/16S-W3
	30	20	420	16	50	74	26	46	36	50	30,33	FI-G-30/20S-W3
	30	25	420	20	52	77	26,5	46	46	50	31,79	FI-G-30/25S-W3
	38	16	420	12	53	80	28,5	55	30	60	46,99	FI-G-38/16S-W3
	38	20	420	16	55	84	28,5	55	36	60	49,57	FI-G-38/20S-W3
	38	25	420	20	57	87	29	55	46	60	51,3	FI-G-38/25S-W3
	38	30	420	25	59	87	29,5	55	50	60	50,90	FI-G-38/30S-W3

¹ Approx.imate dimension in assembled condition.

² Weight excluding cutting rings and union nuts.

³ Standard scope of delivery: Fitting body only.



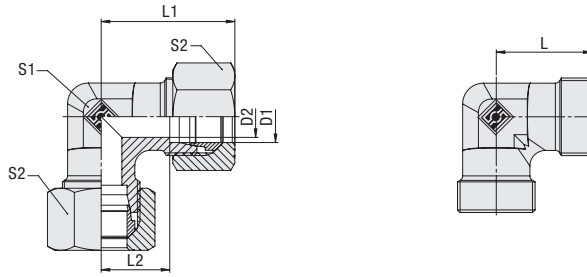

Equal Elbow
Type FI-W ▪ Series LL / L / S



D

Series	Tube OD mm	PN bar	Dimensions mm						Weight kg ca. per 100	Ordering Codes ³
			D1	D2	L	L1 ¹	L2	S1		
LL	4	100	3	15	21	11	9	10	1,29	FI-W-04LL-W3-PR
	6	100	4,5	15	21	9,5	11	12	1,57	FI-W-06LL-W3-PR
	8	100	6	17	23	11,5	12	14	2,22	FI-W-08LL-W3-PR
	10	100	8	18	23	12,5	12	17	2,70	FI-W-10LL-W3-PR
	12	100	10	21	27	15	14	19	2,20	FI-W-12LL-W3
L	6	500	4	19	27	12	12	14	1,94	FI-W-06L-W3
	8	500	6	21	29	14	12	17	2,35	FI-W-08L-W3
	10	500	8	22	30	15	14	19	3,06	FI-W-10L-W3
	12	400	10	24	32	17	17	22	4,34	FI-W-12L-W3
	15	400	12	28	36	21	19	27	5,13	FI-W-15L-W3
	18	400	15	31	40	23,5	24	32	11,63	FI-W-18L-W3
	22	250	19	35	44	27,5	27	36	15,35	FI-W-22L-W3
	28	250	24	38	47	30,5	36	41	25,45	FI-W-28L-W3
	35	250	30	45	56	34,5	41	50	42,04	FI-W-35L-W3
	42	250	36	51	63	40	50	60	63,20	FI-W-42L-W3
	S	6	800	4	23	31	16	12	17	3,32
8		800	5	24	32	17	14	19	4,68	FI-W-08S-W3
10		800	7	25	34	17,5	17	22	6,02	FI-W-10S-W3
12		630	8	29	38	21,5	17	24	8,14	FI-W-12S-W3
14		630	10	30	40	22	19	27	9,86	FI-W-14S-W3
16		630	12	33	43	24,5	24	30	14,13	FI-W-16S-W3
20		420	16	37	48	26,5	27	36	20,50	FI-W-20S-W3
25		420	20	42	54	30	36	46	36,09	FI-W-25S-W3
30		420	25	49	62	35,5	41	50	40,20	FI-W-30S-W3
38		420	32	57	72	41	50	60	89,05	FI-W-38S-W3

¹ Approx.imate dimension in assembled condition.
² Weight excluding cutting rings and union nuts.
³ Standard scope of delivery: Fitting body only.

Ordering Codes

***FI-W*-10*L*-W3*-MS**

* Equal Elbow		FI-W
* Outside Tube Diameter D1 (in mm)		-10
* Series	Extra-Light Series	LL
	Light Series	L
	Heavy Series	S
* Material Code	Steel, zinc/nickel-plated	-W3
Please contact STAUFF for alternative materials and surface finishings.		
* Design	Made from forging blanks	—
	Made from profile material	PR
* Assembling / Kitting	Fitting body only	—
	Fitting body supplied with cutting rings and union nuts	-MS
	Fitting body supplied with soft-sealing cutting rings and union nuts	-MSV

Connecting Parts

	Cutting Ring Type FI-DS	Page 28
	Soft-Sealing Cutting Ring Type FI-WDDS	Page 29
	Support Sleeve Type FI-VH	Page 31
	STAUFF Form EVO Sealing Ring Type FI-FD	Page 32
	Union Nut Type FI-M	Page 33
	37° Flared Tube Fitting Set Type FI-AB	Page 37



Equal Tee
Type FI-T ▪ Series LL / L / S

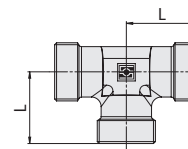
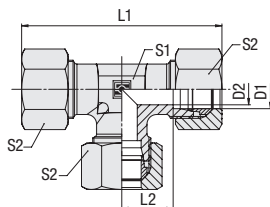

D

Ordering Codes

***FI-T*-10*L*-W3*-MS**

- * Equal Tee **FI-T**
- * Outside Tube Diameter D1 (in mm) **-10**
- * Series **LL**
 Extra-Light Series **L**
 Light Series **S**
 Heavy Series
- * Material Code **-W3**
 Steel, zinc/nickel-plated
- Please contact STAUFF for alternative materials and surface finishings.
- * Assembling / Kitting **—**
 Fitting body only
- Fitting body supplied with cutting rings and union nuts **-MS**
- Fitting body supplied with soft-sealing cutting rings and union nuts **-MSV**

Series	Tube OD mm D1	PN bar	Dimensions						Weight kg ca. per 100	Ordering Codes ³
			mm D2	L	L1 ¹	L2	S1	S2		
LL	4	100	3	15	42	11	9	10	1,00	FI-T-04LL-W3
	6	100	4,5	15	42	9,5	9	12	1,23	FI-T-06LL-W3
	8	100	6	17	46	11,5	12	14	1,91	FI-T-08LL-W3
	10	100	8	21,5	54	16	14	17	3,42	FI-T-10LL-W3
L	12	100	10	21,5	59	15	14	19	3,80	FI-T-12LL-W3
	6	500	4	19	54	12	12	14	2,66	FI-T-06L-W3
	8	500	6	21	58	14	12	17	3,17	FI-T-08L-W3
	10	500	8	22	60	15	14	19	4,06	FI-T-10L-W3
	12	400	10	24	64	17	17	22	5,52	FI-T-12L-W3
	15	400	12	28	72	21	19	27	9,98	FI-T-15L-W3
	18	400	15	31	80	23,5	24	32	14,83	FI-T-18L-W3
	22	250	19	35	88	27,5	27	36	18,81	FI-T-22L-W3
	28	250	24	38	94	30,5	36	41	30,44	FI-T-28L-W3
	35	250	30	45	112	34,5	41	50	49,27	FI-T-35L-W3
	42	250	36	51	126	40	50	60	72,20	FI-T-42L-W3
	S	6	800	4	23	62	16	12	17	4,60
8		800	5	24	64	17	14	19	6,21	FI-T-08S-W3
10		800	7	25	68	17,5	17	22	7,92	FI-T-10S-W3
12		630	8	29	76	21,5	17	24	10,88	FI-T-12S-W3
14		630	10	30	80	22	19	27	12,97	FI-T-14S-W3
16		630	12	33	86	24,5	24	30	10,97	FI-T-16S-W3
20		420	16	37	96	26,5	27	36	25,58	FI-T-20S-W3
25		420	20	42	108	30	36	46	44,75	FI-T-25S-W3
30		420	25	49	124	35,5	41	50	68,20	FI-T-30S-W3
38		420	32	57	144	41	50	60	108,00	FI-T-38S-W3

Connecting Parts

- Cutting Ring
Type **FI-DS** Page 28
- Soft-Sealing Cutting Ring
Type **FI-WDDS** Page 29
- Support Sleeve
Type **FI-VH** Page 31
- STAUFF Form EVO Sealing Ring
Type **FI-FD** Page 32
- Union Nut
Type **FI-M** Page 33
- 37° Flared Tube Fitting Set
Type **FI-AB** Page 37

¹ Approximate dimension in assembled condition.

² Weight excluding cutting rings and union nuts.

³ Standard scope of delivery: Fitting body only.



Tee Reducer
Type FI-T • Series L

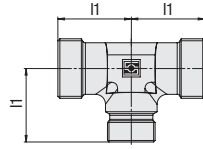
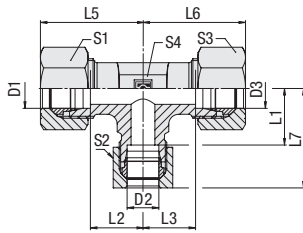

Sequence of connections
in the ordering codes for
tee reducers:



D

Series	Tube OD mm			PN bar	Dimensions mm										Weight kg ca. per 100	Ordering Codes ³	
	D1	D2	D3		I1	L1	L2	L3	L5 ¹	L6 ¹	L7 ¹	S1	S2	S3			S4
L	6	8	6	500	21	14	14	14	29	29	29	14	17	14	12	3,81	FI-T-06/08/06L-W3
	6	10	6	500	22	15	15	15	30	30	30	14	19	14	14	4,90	FI-T-06/10/06L-W3
	8	6	8	500	21	14	14	14	29	29	29	17	14	17	12	3,27	FI-T-08/06/08L-W3
	8	10	8	500	22	15	15	15	30	30	30	17	19	17	14	4,35	FI-T-08/10/08L-W3
	8	12	8	400	24	17	17	17	32	32	32	17	22	17	17	5,94	FI-T-08/12/08L-W3
	10	6	10	500	22	15	15	15	30	30	30	19	14	19	14	4,18	FI-T-10/06/10L-W3
	10	8	10	500	22	15	15	15	30	30	30	19	17	19	14	4,11	FI-T-10/08/10L-W3
	10	10	6	500	21	15	15	14	31	29	30	19	19	14	14	4,13	FI-T-10/10/06L-W3
	10	12	10	400	24	17	17	17	31	31	32	19	22	19	17	5,81	FI-T-10/12/10L-W3
	10	15	10	400	28	21	21	21	36	36	36	19	27	19	19	10,05	FI-T-10/15/10L-W3
	12	6	12	400	24	17	17	17	32	32	32	22	14	22	17	5,66	FI-T-12/06/12L-W3
	12	8	8	400	24	17	17	17	32	32	32	22	17	17	17	5,69	FI-T-12/08/08L-W3
	12	8	12	400	24	17	17	17	32	32	32	22	17	22	17	5,68	FI-T-12/08/12L-W3
	12	10	10	400	24	17	17	17	32	32	32	22	19	19	17	6,62	FI-T-12/10/10L-W3
	12	10	12	400	24	17	17	17	32	32	32	22	19	22	17	5,58	FI-T-12/10/12L-W3
	12	12	8	400	24	17	17	17	33	31	32	22	22	17	17	5,65	FI-T-12/12/08L-W3
	12	15	12	400	28	21	21	21	36	36	36	22	27	22	19	9,73	FI-T-12/15/12L-W3
	12	18	12	400	31	24	23,5	24	40	39	39	22	32	22	24	14,87	FI-T-12/18/12L-W3
	15	6	15	400	28	21	21	21	36	36	36	27	14	27	19	10,06	FI-T-15/06/15L-W3
	15	8	15	400	28	21	21	21	36	36	35	27	17	27	19	8,92	FI-T-15/08/15L-W3
	15	10	15	400	28	21	21	21	36	36	36	27	19	27	19	9,82	FI-T-15/10/15L-W3
	15	12	12	400	28	21	21	21	37	36	36	27	22	22	19	9,41	FI-T-15/12/12L-W3
	15	12	15	400	28	21	21	21	36	36	36	27	22	27	19	9,70	FI-T-15/12/15L-W3
	15	15	12	400	28	21	21	21	36	36	36	27	27	22	19	2,10	FI-T-15/15/12L-W3
	15	18	15	400	31	24	23,5	24	40	39	39	27	32	27	24	15,22	FI-T-15/18/15L-W3

¹ Approx.imate dimension in assembled condition.
² Weight excluding cutting rings and union nuts.
³ Standard scope of delivery: Fitting body only.

Ordering Codes

***FI-T*-10/*08/*10*L*-W3*-MS**

- * Tee Reducer **FI-T**
- * Outside Tube Diameter D1 (in mm) **-10**
- * Outside Tube Diameter D2 (in mm) **08**
- * Outside Tube Diameter D3 (in mm) **10**
- * Series Light Series (page 101/102) **L**
Heavy Series (page 103) **S**
- * Material Code Steel, zinc/nickel-plated **-W3**

Please contact STAUFF for alternative materials and surface finishings.

- * Assembling / Kitting Fitting body only **—**
Fitting body supplied with cutting rings and union nuts **-MS**
Fitting body supplied with soft-sealing cutting rings and union nuts **-MSV**

Connecting Parts

- Cutting Ring Type **FI-DS** Page 28
- Soft-Sealing Cutting Ring Type **FI-WDDS** Page 29
- Support Sleeve Type **FI-VH** Page 31
- STAUFF Form EVO Sealing Ring Type **FI-FD** Page 32
- Union Nut Type **FI-M** Page 33
- 37° Flared Tube Fitting Set Type **FI-AB** Page 37



Tee Reducer
Type FI-T ▪ Series S

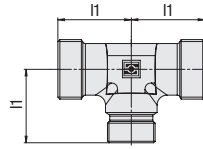
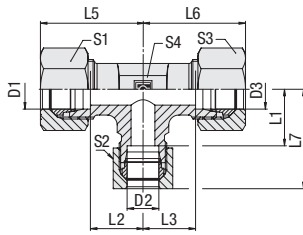

Sequence of connections
in the ordering codes for
tee reducers:



D

Series	Tube OD			PN	Dimensions										Weight	Ordering Codes ³	
	mm	D1	D2		D3	mm	I1	L1	L2	L3	L5 ¹	L6 ¹	L7 ¹	S1			S2
S	12	6	12	630	29	22	21,5	21,5	38,5	38,5	37	24	17	24	17	10,75	FI-T-12/06/12S-W3
	12	8	12	630	29	22	21,5	21,5	38,5	38,5	37,5	24	19	24	17	10,59	FI-T-12/08/12S-W3
	12	16	12	630	33	24,5	25,5	25,5	41	41	43	24	30	24	24	18,74	FI-T-12/16/12S-W3
	16	6	16	630	33	26	24,5	24,5	43	43	41	30	17	30	24	17,85	FI-T-16/06/16S-W3
	16	8	16	630	33	24,5	26	24,5	41	43	43	30	19	30	24	18,08	FI-T-16/08/16S-W3
	16	10	16	630	33	25,5	24,5	24,5	42	43	43	30	22	30	24	18,12	FI-T-16/10/16S-W3
	16	12	12	630	33	25,5	24,5	25,5	43	41	42	30	24	24	24	16,44	FI-T-16/12/12S-W3
	16	12	16	630	33	25,5	24,5	24,5	42	43	43	30	24	30	24	18,10	FI-T-16/12/16S-W3
	16	16	10	630	33	24,5	24,5	25,5	43,5	39,5	43,5	30	30	22	24	17,98	FI-T-16/16/10S-W3
	16	20	16	420	37	26,5	28,5	28,5	47	47	47	30	36	30	27	26,02	FI-T-16/20/16S-W3
	20	10	20	420	37	29,5	26,5	26,5	46	48	48	36	22	36	27	28,30	FI-T-20/10/20S-W3
	20	12	20	420	37	29,5	26,5	26,5	48	48	45,5	36	24	36	27	26,42	FI-T-20/12/20S-W3
	20	16	20	420	37	28,5	26,5	26,5	47	48	48	36	30	36	27	26,21	FI-T-20/16/20S-W3
	20	25	20	420	42	30	31,5	31,5	52	52	54	36	46	36	36	45,59	FI-T-20/25/20S-W3
	25	12	25	420	42	34,5	30	30	54	54	51	46	24	46	36	40,90	FI-T-25/12/25S-W3
	25	16	25	420	42	33,5	30	30	52	54	54	46	30	46	36	45,80	FI-T-25/16/25S-W3
	25	20	25	420	42	31,5	30	30	53	54	54	46	36	46	36	45,04	FI-T-25/20/25S-W3
	25	30	25	420	49	37	35,5	37	62	61	61	46	50	46	41	72,40	FI-T-25/30/25S-W3
	30	20	30	420	49	35,5	38,5	35,5	48	62	62	50	36	50	41	80,00	FI-T-30/20/30S-W3
	38	20	38	420	57	46,5	41	41	72,5	72,5	68	60	36	60	50	108,90	FI-T-38/20/38S-W3
38	25	38	420	57	41	45	41	69	72	72	60	46	60	50	134,72	FI-T-38/25/38S-W3	
38	30	38	400	57	41	43,5	41	70	72	72	60	50	60	50	125,00	FI-T-38/30/38S-W3	

¹ Approx.imate dimension in assembled condition.

² Weight excluding cutting rings and union nuts.

³ Standard scope of delivery: Fitting body only.

Ordering Codes

***FI-T*-12/*06/*12*S*-W3*-MS**

- * Tee Reducer FI-T
- * Outside Tube Diameter D1 (in mm) -12
- * Outside Tube Diameter D2 (in mm) 06
- * Outside Tube Diameter D3 (in mm) 12
- * Series L
Light Series (page 101/102)
- S
Heavy Series (page 103)
- * Material Code -W3
Steel, zinc/nickel-plated
- Please contact STAUFF for alternative materials and surface finishings.
- * Assembling / Kitting -
Fitting body only
- MS
Fitting body supplied with cutting rings and union nuts
- MSV
Fitting body supplied with soft-sealing cutting rings and union nuts

Connecting Parts

-  Cutting Ring
Type **FI-DS** Page 28
-  Soft-Sealing Cutting Ring
Type **FI-WDDS** Page 29
-  Support Sleeve
Type **FI-VH** Page 31
-  STAUFF Form EVO Sealing Ring
Type **FI-FD** Page 32
-  Union Nut
Type **FI-M** Page 33
-  37° Flared Tube Fitting Set
Type **FI-AB** Page 37



Equal Cross
Type FI-K • Series LL / L / S

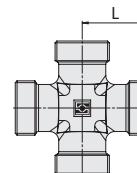
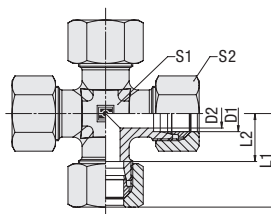

D

Ordering Codes

***FI-K*-10*L*-W3*-MS**

- * Equal Cross **FI-K**
- * Outside Tube Diameter D1 (in mm) **-10**
- * Series **LL**
 - Extra-Light Series **L**
 - Light Series **S**
 - Heavy Series
- * Material Code **-W3**
 - Steel, zinc/nickel-plated
- Please contact STAUFF for alternative materials and surface finishings.
- * Assembling / Kitting **-**
 - Fitting body only
 - Fitting body supplied with cutting rings and union nuts **-MS**
 - Fitting body supplied with soft-sealing cutting rings and union nuts **-MSV**

Series	Tube OD	PN	Dimensions						Weight	Ordering Codes ³
	mm		mm			kg ca.				
	D1		D2	L	L1 ¹	L2	S1	S2	per 100	
LL	4	100	3	15	21	11	9	10	1,68	FI-K-04LL-W3
	6	100	4,5	15	21	9,5	9	12	1,76	FI-K-06LL-W3
	8	100	6	17	23	11,5	12	14	2,85	FI-K-08LL-W3
L	6	500	4	19	27	12	12	14	3,40	FI-K-06L-W3
	8	500	6	21	29	14	12	17	3,93	FI-K-08L-W3
	10	500	8	22	30	15	14	19	5,01	FI-K-10L-W3
	12	400	10	24	32	17	17	22	6,90	FI-K-12L-W3
	15	400	12	28	36	21	19	27	12,36	FI-K-15L-W3
	18	400	15	31	40	23,5	24	32	17,40	FI-K-18L-W3
	22	250	19	35	44	27,5	27	36	22,60	FI-K-22L-W3
	28	250	24	38	47	30,5	36	41	35,60	FI-K-28L-W3
	35	250	30	45	56	34,5	41	50	54,67	FI-K-35L-W3
	42	250	36	51	63	40	50	60	92,70	FI-K-42L-W3
	S	6	800	4	23	31	16	12	17	5,79
8		800	5	24	32	17	14	19	7,91	FI-K-08S-W3
10		800	7	25	34	17,5	17	22	10,13	FI-K-10S-W3
12		630	8	29	38	21,5	17	24	13,59	FI-K-12S-W3
14		630	10	30	40	22	19	27	16,21	FI-K-14S-W3
16		630	12	33	43	24,5	24	30	22,15	FI-K-16S-W3
20		420	16	37	48	26,5	27	36	31,07	FI-K-20S-W3
25		420	20	42	54	30	36	46	53,00	FI-K-25S-W3
30		420	25	49	62	35,5	41	50	84,30	FI-K-30S-W3
38		420	32	57	72	41	50	60	135,10	FI-K-38S-W3

Connecting Parts

- Cutting Ring
Type **FI-DS** Page 28
- Soft-Sealing Cutting Ring
Type **FI-WDDS** Page 29
- Support Sleeve
Type **FI-VH** Page 31
- STAUFF Form EVO Sealing Ring
Type **FI-FD** Page 32
- Union Nut
Type **FI-M** Page 33
- 37° Flared Tube Fitting Set
Type **FI-AB** Page 37

¹ Approximate dimension in assembled condition.

² Weight excluding cutting rings and union nuts.

³ Standard scope of delivery: Fitting body only.



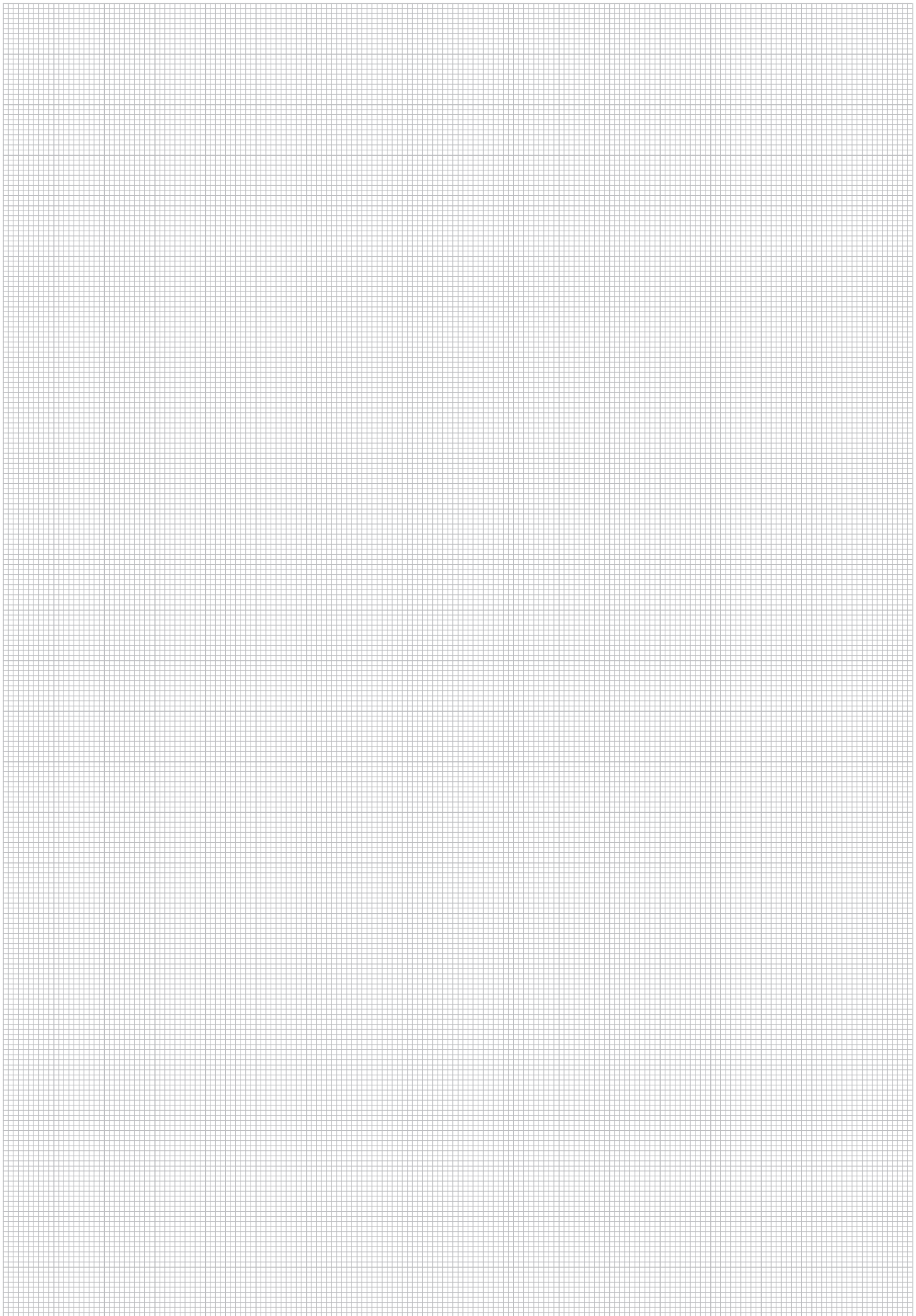



**Straight Bulkhead Fitting**

FI-GS

108

**Elbow Bulkhead Fittings**

FI-WS

109

**Straight Bulkhead Weld Fitting**

FI-ES

110



Straight Bulkhead Fitting Type FI-GS ▪ Series L / S

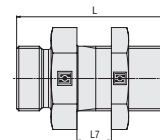
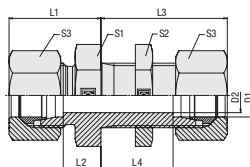

E

Ordering Codes

FI-GS-10*L*-W3*-MS

* Straight Bulkhead Fitting		FI-GS
* Outside Tube Diameter D1 (in mm)		-10
* Series	Light Series	L
	Heavy Series	S
* Material Code	Steel, zinc/nickel-plated	-W3
Please contact STAUFF for alternative materials and surface finishings.		
* Assembling / Kitting	Fitting body only	—
	Fitting body supplied with hexagon lock nut	-SKM
	Fitting body supplied with cutting rings and union nuts	-MS
	Fitting body supplied with soft-sealing cutting rings and union nuts	-MSV

Series	Tube OD mm D1	PN bar	Dimensions mm										Weight kg ca. per 100	Ordering Codes ³
			D2	L	L1 ¹	L2	L3 ¹	L4	L7 max	S1	S2	S3		
L	6	500	4	48	22	7	42	27	16	17	14	3,85	FI-GS-06L-W3-SKM	
	8	500	6	49	23	8	42	27	16	19	17	4,93	FI-GS-08L-W3-SKM	
	10	500	8	52	25	10	43	28	16	22	19	6,76	FI-GS-10L-W3-SKM	
	12	400	10	53	25	10	44	29	16	24	22	7,81	FI-GS-12L-W3-SKM	
	15	400	12	57	27	12	46	31	16	27	30	12,89	FI-GS-15L-W3-SKM	
	18	400	15	61	30	13,5	49	32,5	16	32	36	32	19,87	FI-GS-18L-W3-SKM
	22	250	19	66	33	16,5	51	34,5	16	36	41	36	25,19	FI-GS-22L-W3-SKM
	28	250	24	69	35	18,5	52	35,5	16	41	46	41	34,12	FI-GS-28L-W3-SKM
	35	250	30	76	40	18,5	58	36,5	16	50	55	50	55,40	FI-GS-35L-W3-SKM
	42	250	36	77	42	19	59	36	16	60	65	60	75,30	FI-GS-42L-W3-SKM
S	6	800	4	55	27	12	44	29	16	19	17	6,50	FI-GS-06S-W3-SKM	
	8	800	5	56	28	13	44	29	16	22	19	8,84	FI-GS-08S-W3-SKM	
	10	800	7	59	31	14,5	46	29,5	16	24	24	11,18	FI-GS-10S-W3-SKM	
	12	630	8	60	31	14,5	47	30,5	16	27	24	14,00	FI-GS-12S-W3-SKM	
	14	630	10	65	35	17	50	32	16	30	30	18,17	FI-GS-14S-W3-SKM	
	16	630	12	65	35	16,5	50	31,5	16	32	30	20,12	FI-GS-16S-W3-SKM	
	20	420	16	72	39	17,5	55	33,5	16	41	41	36	34,45	FI-GS-20S-W3-SKM
	25	420	20	79	44	20	59	35	16	46	46	46	49,56	FI-GS-25S-W3-SKM
	30	420	25	86	48	21,5	64	37,5	16	50	50	50	64,90	FI-GS-30S-W3-SKM
	38	420	32	91	53	22	68	37	16	65	65	60	108,30	FI-GS-38S-W3-SKM

¹ Approximate dimension in assembled condition.
² Weight excluding lock nut, cutting rings and union nuts.
³ Standard scope of delivery: Fitting body with hexagon lock nut.

Connecting Parts

	Cutting Ring Type FI-DS	Page 28
	Soft-Sealing Cutting Ring Type FI-WDDS	Page 29
	Support Sleeve Type FI-VH	Page 31
	STAUFF Form EVO Sealing Ring Type FI-FD	Page 32
	Union Nut Type FI-M	Page 33
	37° Flared Tube Fitting Set Type FI-AB	Page 37

Spare Parts / Accessories

	Hexagon Lock Nut Type FI-SKM	Page 237
--	--	----------



Elbow Bulkhead Fittings
Type FI-WS • Series L / S

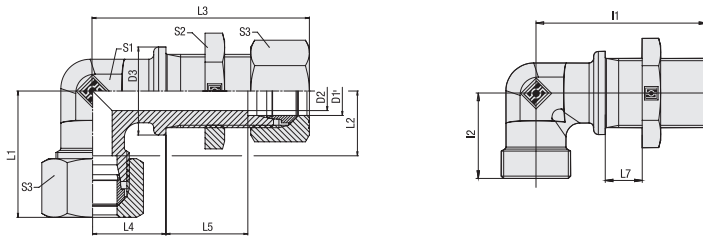

Series	Tube OD mm D1	PN bar	Dimensions mm													Weight kg ca. per 100	Ordering Codes ³	
			D2	L	i1	i2	L1 ¹	L2	L3 ¹	L4	L5	L7 _{min}	L7 _{max}	S1	S2			S3
L	6	500	4	17	48	19	27	12	56	14	27	3	16	12	17	14	4,88	FI-WS-06L-W3-SKM
	8	500	6	19	51	21	29	14	59	17	27	3	16	12	19	17	6,11	FI-WS-08L-W3-SKM
	10	500	8	22	53	22	30	15	61	18	28	3	16	14	22	19	7,89	FI-WS-10L-W3-SKM
	12	400	10	24	56	24	32	17	64	20	29	3	16	17	24	22	9,65	FI-WS-12L-W3-SKM
	15	400	12	27	61	28	36	21	69	23	31	3	16	19	30	27	16,31	FI-WS-15L-W3-SKM
	18	400	15	32	64	31	40	23,5	73	24	32,5	3	16	24	36	32	23,82	FI-WS-18L-W3-SKM
	22	250	19	36	72	35	44	27,5	81	30	34,5	4	16	27	41	36	30,41	FI-WS-22L-W3-SKM
	28	250	24	42	77	38	47	30,5	86	34	35,5	4	16	36	46	41	45,92	FI-WS-28L-W3-SKM
	35	250	30	50	86	45	56	34,5	97	39	36,5	4	16	41	55	50	75,00	FI-WS-35L-W3-SKM
	42	250	36	60	90	51	63	40	102	43	36	4	16	50	65	60	107,00	FI-WS-42L-W3-SKM
S	6	800	4	19	53	23	31	16	61	17	29	3	16	12	19	17	7,34	FI-WS-06S-W3-SKM
	8	800	5	22	54	24	32	17	62	18	29	3	16	14	22	19	10,16	FI-WS-08S-W3-SKM
	10	800	7	24	57	25	34	17,5	66	20	29,5	3	16	17	24	22	12,59	FI-WS-10S-W3-SKM
	12	630	8	27	59	29	38	21,5	68	21	30,5	3	16	17	27	24	16,05	FI-WS-12S-W3-SKM
	14	630	10	27	63	30	40	22	73	23	32	3	16	19	30	27	19,62	FI-WS-14S-W3-SKM
	16	630	12	30	64	33	43	24,5	74	24	31,5	3	16	24	32	30	24,14	FI-WS-16S-W3-SKM
	20	400	16	36	74	37	48	26,5	85	30	33,5	4	16	27	41	36	38,01	FI-WS-20S-W3-SKM
	25	400	20	42	81	42	54	30	93	34	35	4	16	36	46	46	61,10	FI-WS-25S-W3-SKM
	30	400	25	50	90	49	62	35,5	103	39	37,5	4	16	41	50	50	91,00	FI-WS-30S-W3-SKM
	38	400	32	60	96	57	72	41	112	43	37	4	16	50	65	60	138,90	FI-WS-38S-W3-SKM

¹ Approx.imate dimension in assembled condition.

² Weight excluding cutting rings and union nuts.

³ Standard scope of delivery: Fitting body only.

Ordering Codes

***FI-WS*-10*L*-W3*-MS**

* Elbow Bulkhead Fitting	FI-WS
* Outside Tube Diameter D1 (in mm)	-10
* Series	Light Series L Heavy Series S
* Material Code	Steel, zinc/nickel-plated -W3
Please contact STAUFF for alternative materials and surface finishings.	
* Assembling / Kitting	Fitting body only —
	Fitting body supplied with hexagon lock nut -SKM
	Fitting body supplied with cutting rings and union nuts -MS
	Fitting body supplied with soft-sealing cutting rings and union nuts -MSV

Connecting Parts

	Cutting Ring Type FI-DS	Page 28
	Soft-Sealing Cutting Ring Type FI-WDDS	Page 29
	Support Sleeve Type FI-VH	Page 31
	STAUFF Form EVO Sealing Ring Type FI-FD	Page 32
	Union Nut Type FI-M	Page 33
	37° Flared Tube Fitting Set Type FI-AB	Page 37

Spare Parts / Accessories

	Hexagon Lock Nut Type FI-SKM	Page 237
--	---------------------------------	----------



Straight Bulkhead Weld Fitting Type FI-ES ▪ Series L / S

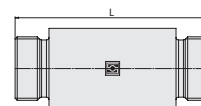
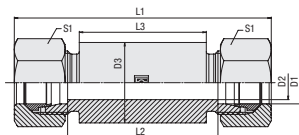

E

Ordering Codes

FI-ES-10*L*-W159*-MS

* Straight Bulkhead Weld Fitting	FI-ES
* Outside Tube Diameter D1 (in mm)	-10
* Series	Light Series L Heavy Series S
* Material Code	Steel, phosphated -W2 Fitting body: Steel, phosphated -W159 Connecting parts: Steel, zinc/nickel-plated
Please contact STAUFF for alternative materials and surface finishings.	
* Assembling / Kitting	Fitting body only — Fitting body supplied with cutting rings and union nuts -MS Fitting body supplied with soft-sealing cutting rings and union nuts -MSV

Series	Tube OD mm	PN bar	Dimensions mm							Weight kg ca. per 100	Ordering Codes ³
			D1	D2	D3	L	L1 ¹	L2	L3		
L	6	500	4	18	70	85	56	50	14	10,33	FI-ES-06L-W2
	8	500	6	20	70	85	56	50	17	12,21	FI-ES-08L-W2
	10	500	8	22	72	87	58	50	19	14,30	FI-ES-10L-W2
	12	400	10	25	72	87	58	50	22	17,75	FI-ES-12L-W2
	15	400	12	28	84	100	70	60	27	26,69	FI-ES-15L-W2
	18	400	15	32	84	101	69	60	32	33,60	FI-ES-18L-W2
	22	250	19	36	88	105	73	60	36	39,92	FI-ES-22L-W2
	28	250	24	40	88	106	73	60	41	45,18	FI-ES-28L-W2
	35	250	30	50	92	114	71	60	50	72,80	FI-ES-35L-W2
	42	250	36	60	92	115	70	60	60	100,60	FI-ES-42L-W2
S	6	800	4	20	74	89	60	50	17	13,56	FI-ES-06S-W2
	8	800	5	22	74	89	60	50	19	16,35	FI-ES-08S-W2
	10	800	7	25	74	91	59	50	22	20,24	FI-ES-10S-W2
	12	630	8	28	74	91	59	50	24	25,17	FI-ES-12S-W2
	14	630	10	30	88	107	72	60	27	33,72	FI-ES-14S-W2
	16	630	12	35	88	107	71	60	30	44,42	FI-ES-16S-W2
	20	420	16	38	92	114	71	60	36	51,50	FI-ES-20S-W2
	25	420	20	45	96	120	72	60	46	72,50	FI-ES-25S-W2
	30	420	25	50	100	126	73	60	50	87,80	FI-ES-30S-W2
	38	420	32	60	104	133	72	60	60	125,30	FI-ES-38S-W2

¹ Approximate dimension in assembled condition.

² Weight excluding cutting rings and union nuts.

³ Standard scope of delivery: Fitting body only.

Connecting Parts

	Cutting Ring Type FI-DS	Page 28
	Soft-Sealing Cutting Ring Type FI-WDDS	Page 29
	Support Sleeve Type FI-VH	Page 31
	STAUFF Form EVO Sealing Ring Type FI-FD	Page 32
	Union Nut Type FI-M	Page 33
	37° Flared Tube Fitting Set Type FI-AB	Page 37



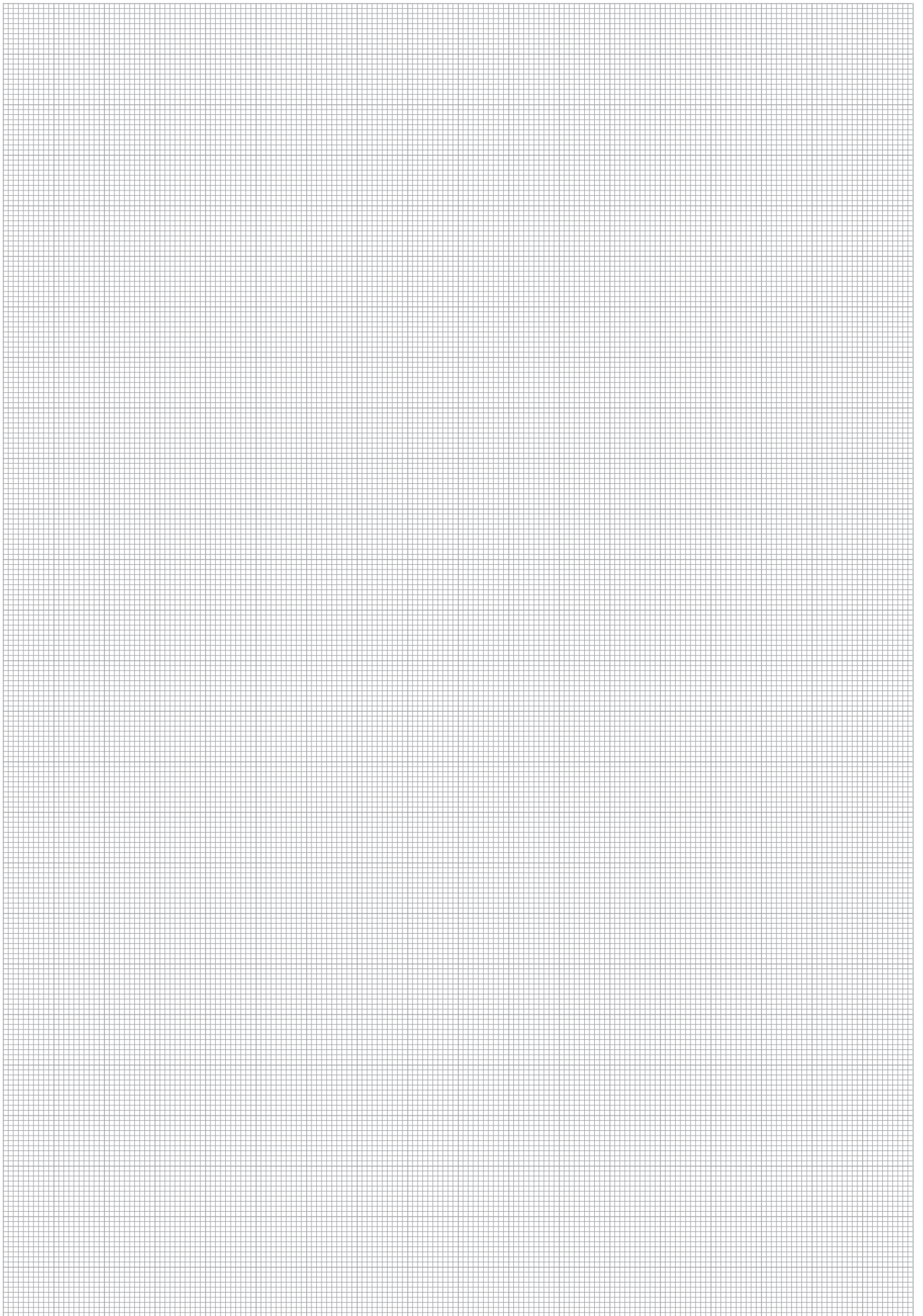





Straight Weld Fitting

FI-AS

114



Elbow Weld Fitting

FI-WAS

115



24° Weld Cone with O-Ring

FI-SN

116



24° Weld Cone Reducer with O-Ring

FI-SNR

118



Straight Weld Fitting for Tubes

FI-ASV

120

F



Straight Weld Fitting Type FI-AS ▪ Series L / S

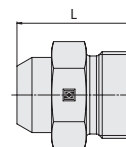
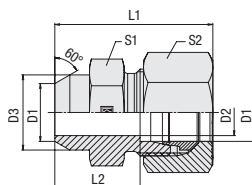

Ordering Codes

FI-AS-10*L*-W159*-MS

* Straight Weld Fitting		FI-AS
* Outside Tube Diameter D1 (in mm)		-10
* Series	Light Series Heavy Series	L S
* Material Code	Steel, phosphated	-W2
	Fitting body: Steel, phosphated Connecting parts: Steel, zinc/nickel-plated	-W159
Please contact STAUFF for alternative materials and surface finishings.		
* Assembling / Kitting	Fitting body only	—
	Fitting body supplied with cutting ring and union nut	-MS
	Fitting body supplied with soft-sealing cutting ring and union nut	-MSV

Series	Tube OD mm D1	PN bar	Dimensions mm							Weight kg ca. per 100	Ordering Codes ³
			D2	D3	L	L1 ¹	L2	S1	S2		
L	6	500	4	10	21	29	14	12	14	1,06	FI-AS-06L-W2
	8	500	6	12	23	31	16	14	17	1,52	FI-AS-08L-W2
	10	500	8	14	25	33	18	17	19	2,20	FI-AS-10L-W2
	12	400	10	16	25	33	18	19	22	2,57	FI-AS-12L-W2
	15	400	12	19	29	37	22	22	27	4,37	FI-AS-15L-W2
	18	400	15	22	31	40	23,5	27	32	6,70	FI-AS-18L-W2
	22	250	19	27	36	45	28,5	32	36	9,87	FI-AS-22L-W2
	28	250	24	32	38	47	30,5	41	41	16,10	FI-AS-28L-W2
	35	250	30	40	43	54	32,5	46	50	23,43	FI-AS-35L-W2
	42	250	36	46	46	58	35	55	60	32,82	FI-AS-42L-W2
S	6	800	4	11	26	34	19	14	17	2,06	FI-AS-06S-W2
	8	800	5	13	28	36	21	17	19	3,12	FI-AS-08S-W2
	10	800	7	15	30	39	22,5	19	22	4,12	FI-AS-10S-W2
	12	630	8	17	32	41	24,5	22	24	4,80	FI-AS-12S-W2
	14	630	10	19	35	45	27	24	27	7,11	FI-AS-14S-W2
	16	630	12	21	35	45	26,5	27	30	8,36	FI-AS-16S-W2
	20	400	16	26	40	51	29,5	32	36	13,01	FI-AS-20S-W2
	25	400	20	31	44	56	32	41	46	22,16	FI-AS-25S-W2
	30	400	25	36	49	62	35,5	46	50	23,12	FI-AS-30S-W2
	38	400	32	44	54	69	38	55	60	45,26	FI-AS-38S-W2

¹ Approximate dimension in assembled condition.

² Weight excluding cutting ring and union nut.

³ Standard scope of delivery: Fitting body only.

Connecting Parts

	Cutting Ring Type FI-DS	Page 28
	Soft-Sealing Cutting Ring Type FI-WDDS	Page 29
	Support Sleeve Type FI-VH	Page 31
	STAUFF Form EVO Sealing Ring Type FI-FD	Page 32
	Union Nut Type FI-M	Page 33
	37° Flared Tube Fitting Set Type FI-AB	Page 37

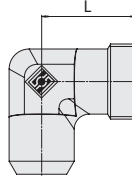
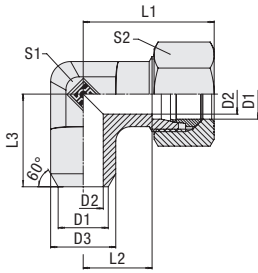

**Elbow Weld Fitting
Type FI-WAS • Series L / S**

Series	Tube OD mm	PN bar	Dimensions mm								Weight kg ca. per 100	Ordering Codes ³
			D1	D2	D3	L	L1 ¹	L2	L3	S1		
L	6	315	4	10	19	28	12	19	12	14	23	FI-WAS-06L-W2
	8	315	6	12	21	29	14	23	12	17	2,56	FI-WAS-08L-W2
	10	315	8	14	22	30	15	24	14	19	3,34	FI-WAS-10L-W2
	12	315	10	16	24	32	17	25	17	22	4,52	FI-WAS-12L-W2
	15	315	12	19	28	36	21	30	19	27	7,88	FI-WAS-15L-W2
	18	315	15	22	31	40	23,5	33	24	32	11,53	FI-WAS-18L-W2
	22	160	19	27	35	44	27,5	37	27	36	16,10	FI-WAS-22L-W2
	28	160	24	32	38	47	30,5	42	36	41	5,99	FI-WAS-28L-W2
	35	160	30	40	45	56	34,5	49	41	50	42,27	FI-WAS-35L-W2
	42	160	36	46	51	63	40	57	50	60	65,80	FI-WAS-42L-W2
S	6	400	4	11	23	30	16	23	12	17	30,96	FI-WAS-06S-W2
	8	400	5	13	24	31	17	24	14	19	43,75	FI-WAS-08S-W2
	10	400	7	15	25	33	17,5	25	17	22	56,74	FI-WAS-10S-W2
	12	400	8	17	29	38	21,5	29	17	24	8,03	FI-WAS-12S-W2
	14	400	10	19,3	30	40	22	30	19	27	9,89	FI-WAS-14S-W2
	16	400	12	21	33	43	24,5	33	24	30	13,89	FI-WAS-16S-W2
	20	400	16	26	37	48	26,5	37	27	36	20,24	FI-WAS-20S-W2
	25	400	20	31	42	54	30	42	36	46	35,01	FI-WAS-25S-W2
	30	400	25	36	49	62	35,5	49	41	50	53,00	FI-WAS-30S-W2
	38	315	32	44	57	72	41	57	50	60	83,70	FI-WAS-38S-W2

¹ Approx.imate dimension in assembled condition.

² Weight excluding cutting ring and union nut.

³ Standard scope of delivery: Fitting body only.

Ordering Codes
***FI-WAS*-10*L*-W159*-MS**

* Elbow Weld Fitting		FI-WAS
* Outside Tube Diameter D1 (in mm)		-10
* Series	Light Series	L
	Heavy Series	S
* Material Code	Steel, phosphated	-W2
	Fitting body: Steel, phosphated	-W159
	Connecting parts: Steel, zinc/nickel-plated	
	Please contact STAUFF for alternative materials and surface finishings.	
* Assembling / Kitting	Fitting body only	—
	Fitting body supplied with cutting ring and union nut	-MS
	Fitting body supplied with soft-sealing cutting ring and union nut	-MSV

Connecting Parts

	Cutting Ring Type FI-DS	Page 28
	Soft-Sealing Cutting Ring Type FI-WDDS	Page 29
	Support Sleeve Type FI-VH	Page 31
	STAUFF Form EVO Sealing Ring Type FI-FD	Page 32
	Union Nut Type FI-M	Page 33
	37° Flared Tube Fitting Set Type FI-AB	Page 37

F

24° Weld Cone with O-Ring Type FI-SN • Series L / S

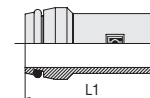
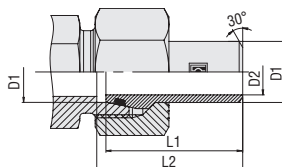

Ordering Codes

FI-SN-10x1.5*-B*-W2

* 24° Weld Cone with O-Ring	FI-SN
* Outside Tube Diameter (in mm)	-10
* Wall Thickness (in mm)	x1.5
* Seal Material	-B
NBR (Buna-N®)	
FKM (Viton®)	-V
* Material Code	-W2
Steel, phosphated	

Please contact STAUFF for alternative materials and surface finishings.

FI-SN-10*L*x1.5*-B*-W159*-M

* 24° Weld Cone with O-Ring	FI-SN
* Outside Tube Diameter (in mm)	-10
* Series	L
Light Series (page 116)	
Heavy Series (pages 117)	S
* Wall Thickness (in mm)	x1.5
* Seal Material	-B
NBR (Buna-N®)	
FKM (Viton®)	-V
* Material Code	-W159
Weld cone:	
Steel, phosphated	
Union nut:	
Steel, zinc/nickel-plated	

Please contact STAUFF for alternative materials and surface finishings.

* Assembling / Kitting 24° weld cone with O-ring supplied with union nut	-M
--	-----------

Series	Tube OD		PN bar	Dimensions			Weight kg ca. per 100	Ordering Codes ³
	mm D1	for Tube		mm D2	L1	L2		
L/S	6	6 x 1,5	400	3	31	32	0,70	FI-SN-6x1.5-B-W2
	8	8 x 1,5	315	5	31	32	0,90	FI-SN-8x1.5-B-W2
	8	8 x 2,0	400	4	31	32	1,10	FI-SN-8x2-B-W2
	10	10 x 1,0	250	8	32,5	33,5	0,89	FI-SN-10x1-B-W2
	10	10 x 1,5	250	7	32,5	33,5	1,30	FI-SN-10x1.5-B-W2
	10	10 x 2,0	315	6	32,5	33,5	1,60	FI-SN-10x2-B-W2
	10	10 x 2,5	400	5	32,5	33,5	1,80	FI-SN-10x2.5-B-W2
	12	12 x 1,5	160	9	32,5	33,5	1,60	FI-SN-12x1.5-B-W2
	12	12 x 2,0	250	8	32,5	33,5	1,90	FI-SN-12x2-B-W2
	12	12 x 2,5	315	7	32,5	33,5	2,20	FI-SN-12x2.5-B-W2
	12	12 x 3,0	400	6	32,5	33,5	2,4	FI-SN-12x3-B-W2
	L	15	15 x 2,0	250	11	35	36	2,70
15		15 x 2,5	315	10	35	36	3,00	FI-SN-15x2.5-B-W2
18		18 x 2,0	160	14	36	37	3,76	FI-SN-18x2-B-W2
18		18 x 2,5	315	18	36	37	3,79	FI-SN-18x2.5-B-W2
22		22 x 2,0	160	22	38,5	39,5	4,46	FI-SN-22x2-B-W2
22		22 x 2,5	160	17	38,5	39,5	5,21	FI-SN-22x2.5-B-W2
22		22 x 3,0	160	16	38,5	39,5	5,72	FI-SN-22x3-B-W2
28		28 x 2,5	160	23	41,5	42,5	7,27	FI-SN-28x2.5-B-W2
28		28 x 3,0	160	22	41,5	42,5	8,34	FI-SN-28x3-B-W2
35		35 x 3,0	160	29	47	49,5	12,62	FI-SN-35x3-B-W2
35		35 x 3,5	160	28	47	49,5	14,05	FI-SN-35x3.5-B-W2
35		35 x 4,0	160	27	47	49,5	15,59	FI-SN-35x4-B-W2
42	42 x 3,0	160	36	47	50	15,13	FI-SN-42x3-B-W2	
42	42 x 4,0	160	34	47	50	19,10	FI-SN-42x4-B-W2	

¹ Approximate dimension in assembled condition.

² Weight excluding union nut.

³ Standard scope of delivery: 24° weld cone and O-ring.

Standard seal material is NBR (Buna-N®).

Connecting Parts



Union Nut
Type **FI-M**

Page 33

Spare Parts / Accessories



O-Ring
Type **O-RING**

Page 239

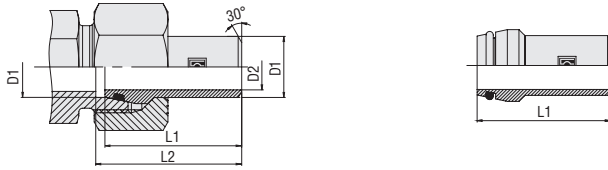

**24° Weld Cone with O-Ring
Type FI-SN • Series S**

Series	Tube OD mm	PN bar	Dimensions mm			Weight kg ca. per 100	Ordering Codes ³	
			D1	for Tube	D2			L1
S	14	14 x 2,0	315	10	38,5	39,5	2,75	FI-SN-14x2-B-W2
	14	14 x 2,5	400	9	38,5	39,5	3,17	FI-SN-14x2.5-B-W2
	14	14 x 3,0	400	8	38,5	39,5	3,56	FI-SN-14x3-B-W2
	16	16 x 1,5	250	13	39	41	2,69	FI-SN-16x1.5-B-W2
	16	16 x 2,0	315	12	39	41	3,29	FI-SN-16x2-B-W2
	16	16 x 2,5	400	11	39	41	3,81	FI-SN-16x2.5-B-W2
	16	16 x 3,0	400	10	39	41	4,23	FI-SN-16x3-B-W2
	20	20 x 2,0	160	16	44,5	47	4,77	FI-SN-20x2-B-W2
	20	20 x 2,5	250	15	44,5	47	5,48	FI-SN-20x2.5-B-W2
	20	20 x 3,0	400	14	44,5	47	6,39	FI-SN-20x3-B-W2
	20	20 x 3,5	400	13	44,5	47	7,15	FI-SN-20x3.5-B-W2
	20	20 x 4,0	400	12	44,5	47	7,73	FI-SN-20x4-B-W2
	25	25 x 2,5	250	20	49,5	53,5	7,89	FI-SN-25x2.5-B-W2
	25	25 x 3,0	315	19	49,5	53,5	9,00	FI-SN-25x3-B-W2
	25	25 x 4,0	400	17	49,5	53,5	10,89	FI-SN-25x4-B-W2
	25	25 x 5,0	400	15	49,5	53,5	12,90	FI-SN-25x5-B-W2
	30	30 x 3,0	160	24	52	57,5	11,55	FI-SN-30x3-B-W2
	30	30 x 4,0	250	22	52	57,5	14,65	FI-SN-30x4-B-W2
	30	30 x 5,0	315	20	52	57,5	16,91	FI-SN-30x5-B-W2
	38	38 x 3,0	160	32	56,5	64,5	16,02	FI-SN-38x3-B-W2
38	38 x 4,0	315	30	56,5	64,5	20,29	FI-SN-38x4-B-W2	
38	38 x 5,0	315	28	56,5	64,5	24,05	FI-SN-38x5-B-W2	
38	38 x 6,0	315	26	56,5	64,5	27,91	FI-SN-38x6-B-W2	

¹ Approximate dimension in assembled condition.

² Weight excluding union nut.

³ Standard scope of delivery: 24° weld cone and O-ring.

Standard seal material is NBR (Buna-N®).

Ordering Codes
***FI-SN*-14x2*-B*-W2**

* 24° Weld Cone with O-Ring	FI-SN
* Outside Tube Diameter (in mm)	-14
* Wall Thickness (in mm)	x2
* Seal Material	NBR (Buna-N®) -B FKM (Viton®) -V
* Material Code	Steel, phosphated -W2

Please contact STAUFF for alternative materials and surface finishings.

***FI-SN*-14Sx2*-B*-W159*-M**

* 24° Weld Cone with O-Ring	FI-SN
* Outside Tube Diameter (in mm)	-14
* Wall Thickness (in mm)	x2
* Series	Light Series (page 116) L Heavy Series (pages 117) S
* Seal Material	NBR (Buna-N®) -B FKM (Viton®) -V
* Material Code	Weld cone: Steel, phosphated -W159 Union nut: Steel, zinc/nickel-plated

Please contact STAUFF for alternative materials and surface finishings.

* Assembling / Kitting 24° weld cone with O-ring supplied with union nut -M

Connecting Parts

Union Nut
Type FI-M

Page 33

Spare Parts / Accessories

O-Ring
Type O-RING

Page 239

F

24° Weld Cone Reducer with O-Ring Type FI-SNR • Series L / S

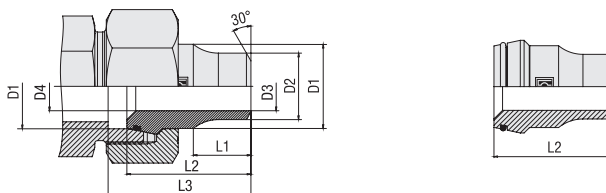

F

Ordering Codes

FI-SNR-10/*08*x2.5*-B*-W2

- * 24° Weld Cone Reducer with O-Ring FI-SNR
- * Outside Tube Diameter D1 (in mm) -10/
- * Outside Tube Diameter D2 (in mm) -08
- * Wall Thickness (in mm) x2.5
- * Seal Material -B
NBR (Buna-N®)
FKM (Viton®) -V
- * Material Code -W2
Steel, phosphated

Please contact STAUFF for alternative materials and surface finishings.

FI-SNR-10*L/*08*x2.5*-B*-W159*-M

- * 24° Weld Cone Reducer with O-Ring FI-SNR
- * Outside Tube Diameter D1 (in mm) -10
- * Series L
Light Series
Heavy Series S
- * Outside Tube Diameter D2 (in mm) -08
- * Wall Thickness (in mm) x2.5
- * Seal Material -B
NBR (Buna-N®)
FKM (Viton®) -V
- * Material Code -W159
Weld cone:
Steel, phosphated
Union nut:
Steel, zinc/nickel-plated

Please contact STAUFF for alternative materials and surface finishings.

- * Assembling / Kitting 24° weld cone with O-ring supplied with union nut -M

Series	Tube OD	PN bar	Dimensions							Weight kg ca. per 100	Ordering Codes ³
	mm		for Tube		mm						
	D1		D2	D3	D4	L1	L2	L3			
L/S	8	6 x 2,0	400	6	2	5	12	31	32	1,45	FI-SNR-08/06x2-B-W2
	10	8 x 2,5	400	8	3	6,50	12	32,5	33,5	1,75	FI-SNR-10/08x2.5-B-W2
	12	10 x 3,0	400	10	4	8	14	32,5	33,5	2,19	FI-SNR-12/10x3-B-W2
S	14	12 x 3,5	400	12	5	9	15	38,5	39,5	3,56	FI-SNR-14/12x3.5-B-W2
	16	12 x 2,0	250	12	8	11	17	38,5	41	4,70	FI-SNR-16/12x2-B-W2
	20	12 x 3,5	400	12	5	14	17	44,5	47	8,55	FI-SNR-20/12x3.5-B-W2
	20	16 x 2,0	315	16	12	14	17	44,5	47	6,65	FI-SNR-20/16x2-B-W2
	20	16 x 3,0	315	16	10	14	17	44,5	47	7,73	FI-SNR-20/16x3-B-W2
	25	16 x 2,0	315	16	12	18	20	49,5	53	11,72	FI-SNR-25/16x2-B-W2
	25	16 x 3,0	315	16	10	18	20	49,5	53	12,96	FI-SNR-25/16x3-B-W2
	25	20 x 2,0	160	20	16	18	20	49,5	53	11,72	FI-SNR-25/20x2-B-W2
	25	20 x 4,0	400	20	12	18	20	49,5	53	12,82	FI-SNR-25/20x4-B-W2
	30	16 x 3,0	315	16	10	22	22	52	57,5	19,04	FI-SNR-30/16x3-B-W2
	30	20 x 4,0	315	20	12	22	22	52	57,5	19,31	FI-SNR-30/20x4-B-W2
	30	25 x 5,0	315	25	15	22	22	52	57,5	16,91	FI-SNR-30/25x5-B-W2
	38	16 x 3,0	315	16	10	30	26	56	62	29,79	FI-SNR-38/16x3-B-W2
	38	20 x 4,0	315	20	12	30	26	56	62	30,32	FI-SNR-38/20x4-B-W2
	38	25 x 5,0	315	25	15	30	26	56	62	30,95	FI-SNR-38/25x5-B-W2
38	30 x 4,0	315	30	22	30	26	56	62	26,36	FI-SNR-38/30x4-B-W2	

¹ Approx.imate dimension in assembled condition.

² Weight excluding union nut.

³ Standard scope of delivery: 24° weld cone and O-ring.

Standard seal material is NBR (Buna-N®).

Connecting Parts



Union Nut
Type FI-M

Page 33

Spare Parts / Accessories



O-Ring
Type O-RING

Page 239



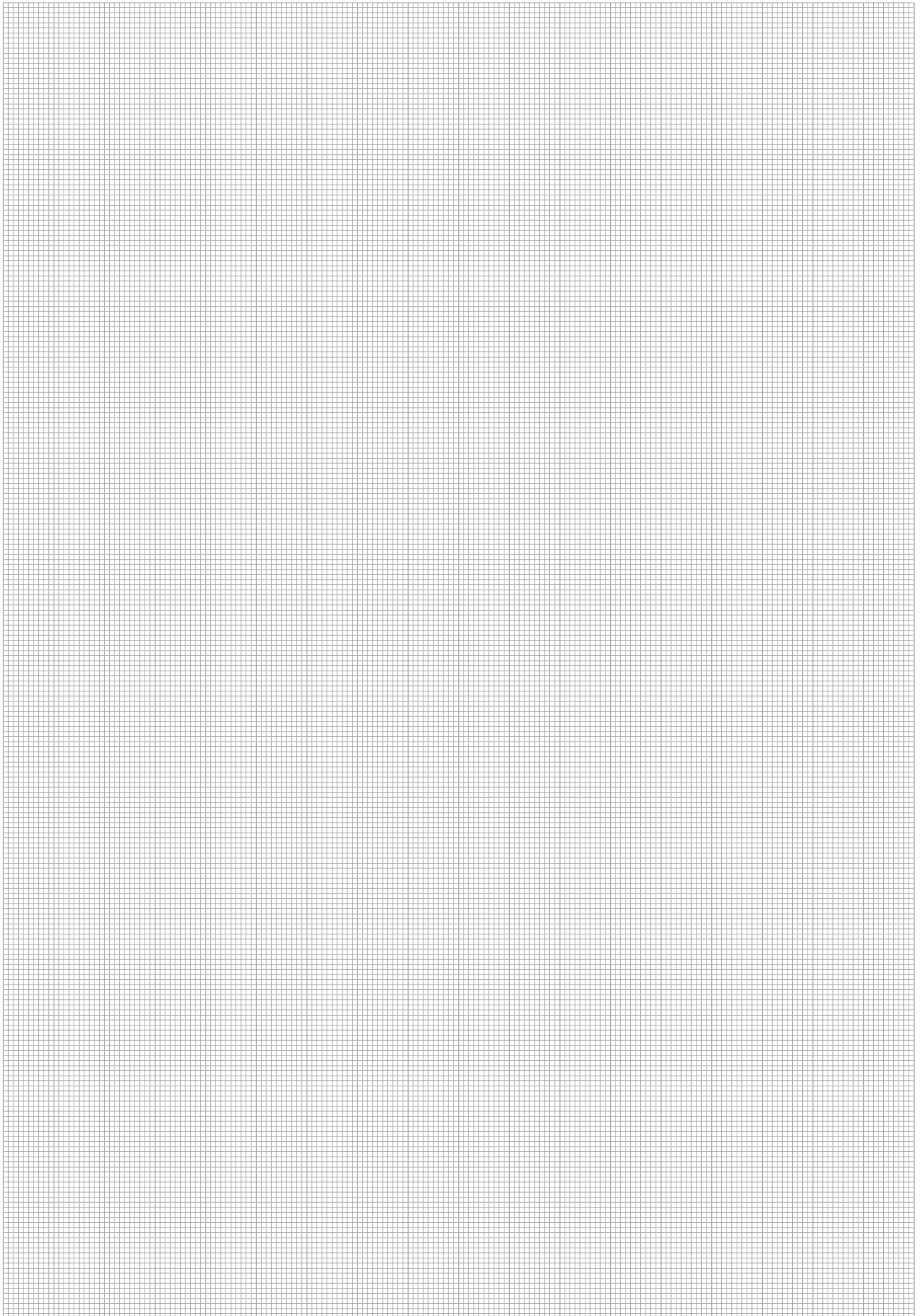

Straight Weld Fitting for Tubes Type FI-ASV • Series S

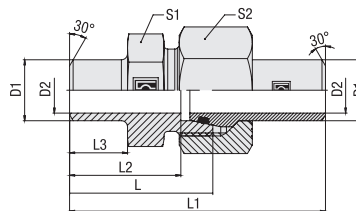

F

Ordering Codes

***FI-ASV*-06*S*x1.5*-B*-W159*-MSN**

* Straight Weld Fitting for Tubes	FI-ASV
* Outside Tube Diameter (in mm)	-06
* Series	Heavy Series S
* Wall Thickness (in mm)	x1.5
* Seal Material	NBR (Buna-N®) -B FKM (Viton®) -V
* Material Code	Steel, phosphated -W2 Fitting body / weld cone: Steel, phosphated -W159 Union nut: Steel, zinc/nickel-plated

Please contact STAUFF for alternative materials and surface finishings.

* Assembling / Kitting Straight weld fitting for tubes supplied with 24° weld cone with O-ring and union nut **-MSN**

Series	Tube OD		PN bar	Dimensions								Weight kg ca. per 100	Ordering Codes ³
	mm	for Tube		mm	L	L ¹	L2	L3	S1	S2			
S	10	10 x 1,0	249	8	32	58	24,5	10	19	22	8,11	FI-ASV-10Sx1-B-W159-MSN	
	10	10 x 1,5	358	7	32	58	24,5	10	19	22	8,54	FI-ASV-10Sx1.5-B-W159-MSN	
	10	10 x 2,0	460	6	32	58	24,5	10	19	22	8,99	FI-ASV-10Sx2-B-W159-MSN	
	12	12 x 1,5	305	9	37	63	29,5	15	22	24	10,47	FI-ASV-12Sx1.5-B-W159-MSN	
	12	12 x 2,0	393	8	37	63	29,5	15	22	24	11,00	FI-ASV-12Sx2-B-W159-MSN	
	12	12 x 2,5	476	7	37	63	29,5	15	22	24	11,54	FI-ASV-12Sx2.5-B-W159-MSN	
	16	16 x 1,5	234	13	41,5	74	33	16,5	27	30	17,40	FI-ASV-16Sx1.5-B-W159-MSN	
	16	16 x 2,0	305	12	41,5	74	33	16,5	27	30	18,30	FI-ASV-16Sx2-B-W159-MSN	
	16	16 x 2,5	372	11	41,5	74	33	16,5	27	30	19,27	FI-ASV-16Sx2.5-B-W159-MSN	
	16	16 x 3,0	400	10	41,5	74	33	16,5	27	30	20,09	FI-ASV-16Sx3-B-W159-MSN	
	20	20 x 2,0	249	16	47	84	36,5	19	32	36	28,18	FI-ASV-20Sx2-B-W159-MSN	
	20	20 x 2,5	305	15	47	84	36,5	19	32	36	29,67	FI-ASV-20Sx2.5-B-W159-MSN	
	20	20 x 3,0	358	14	47	84	36,5	19	32	36	31,08	FI-ASV-20Sx3-B-W159-MSN	
	20	20 x 4,0	400	12	47	84	36,5	19	32	36	33,10	FI-ASV-20Sx4-B-W159-MSN	
	25	25 x 3,0	294	19	51,5	93	39,5	19,5	41	46	53,44	FI-ASV-25Sx3-B-W159-MSN	
	25	25 x 4,0	379	17	51,5	93	39,5	19,5	41	46	57,29	FI-ASV-25Sx4-B-W159-MSN	
	25	25 x 5,0	400	15	51,5	93	39,5	19,5	41	46	59,90	FI-ASV-25Sx5-B-W159-MSN	
	30	30 x 3,0	249	24	58	102	44,5	23	46	50	66,38	FI-ASV-30Sx3-B-W159-MSN	
	30	30 x 4,0	323	22	58	102	44,5	23	46	50	71,62	FI-ASV-30Sx4-B-W159-MSN	
	30	30 x 5,0	393	20	58	102	44,5	23	46	50	75,33	FI-ASV-30Sx5-B-W159-MSN	
	30	30 x 6,0	400	18	58	102	44,5	23	46	50	79,03	FI-ASV-30Sx6-B-W159-MSN	
	38	38 x 4,0	261	30	60	109	44	22	55	60	102,93	FI-ASV-38Sx4-B-W159-MSN	
	38	38 x 5,0	315	28	60	109	44	22	55	60	108,61	FI-ASV-38Sx5-B-W159-MSN	
	38	38 x 6,0	315	26	60	109	44	22	55	60	114,48	FI-ASV-38Sx6-B-W159-MSN	
	38	38 x 7,0	315	24	60	109	44	22	55	60	119,83	FI-ASV-38Sx7-B-W159-MSN	

Connecting Parts



Union Nut
Type **FI-M**

Page 33

Spare Parts / Accessories



O-Ring
Type **O-RING**

Page 239

¹ Approximate dimension in assembled condition.

² Weight including 24° weld cone and union nut.





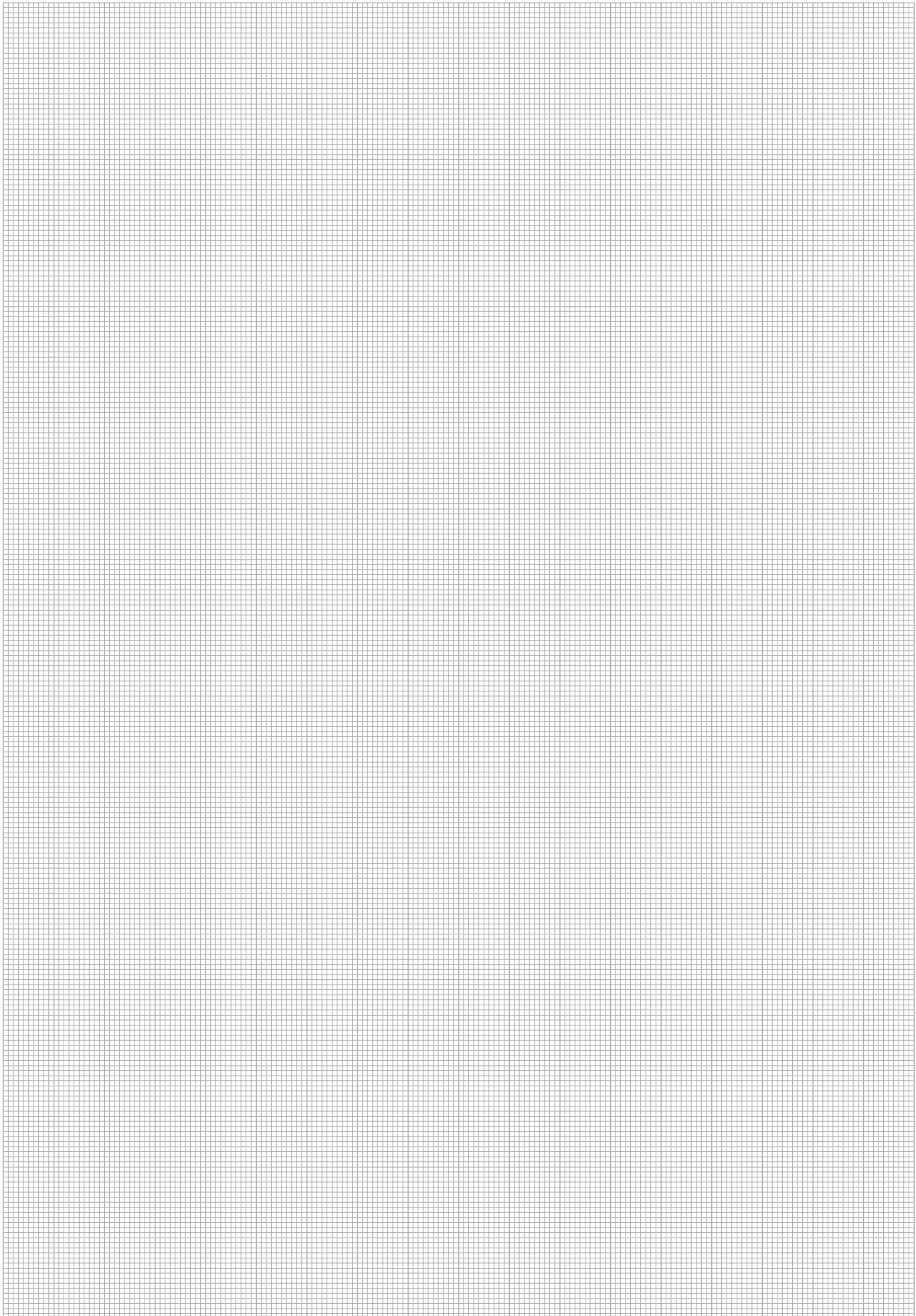

³ Standard scope of delivery:
24° weld cone, O-ring and union nut.

Standard seal material is NBR (Buna-N®).







	Straight Female Stud Fitting	124-127
	FI-GA	
	Female Whitworth Parallel Pipe Thread (BSPP)	124
	FI-GA-...-R	
	Female Metric Parallel Thread	126
	FI-GA-...-M	
	Female NPT Thread	127
	FI-GA-...-N	
	Gauge Fitting	129
	FI-MA	
	Female Whitworth Parallel Pipe Thread (BSPP) / Internal Metallic Sealing Ring	129
	FI-MA-...-R	
	Gauge Fitting with 24° Taper / O-Ring	130
	FI-EMAD	
	Female Whitworth Parallel Pipe Thread (BSPP) / Internal Metallic Sealing Ring	130
	FI-EMAD-...-R	
	Gauge Standpipe Fitting	131
	FI-EMA	
	Female Whitworth Parallel Pipe Thread (BSPP) / Internal Metallic Sealing Ring	131
	FI-EMA-...-R	



Straight Female Stud Fitting
Type FI-GA-...-R ■ Series L

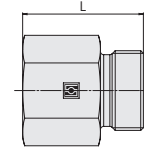
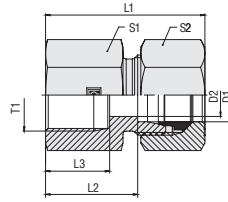

Female Whitworth Parallel Pipe Thread (BSPP)

Ordering Codes

***FI-GA*-10*L*R*-W3*-MS**

- * Straight Female Stud Fitting FI-GA
- * Outside Tube Diameter D1 (in mm) -10
- * Series L
Light Series (page 124)
Heavy Series (page 125) S
- * Thread Type R
Female Whitworth Parallel
Pipe Thread (BSPP)
- If required, please indicate special sizes, e.g. R3/8!
- * Material Code -W3
Steel, zinc/nickel-plated
- Please contact STAUFF for alternative materials and surface finishings.
- * Assembling / Kitting —
Fitting body only
- Fitting body supplied with cutting ring and union nut -MS
- Fitting body supplied with soft-sealing cutting ring and union nut -MSV

Series	Tube OD mm D1	PN bar	Dimensions mm									Weight kg ca. per 100	Ordering Codes ³
			Thread T	D2	L	L1 ¹	L2	L3	S1	S2			
L	6	315	G 1/8	4	26	34	19	12	14	14	3,26	FI-GA-06LR-W3	
	6	315	G 1/4	4	31	39	24	18	19	14	3,78	FI-GA-06LR1/4-W3	
	6	315	G 3/8	6	26	34	19	12	14	17	5,88	FI-GA-06LR3/8-W3	
	8	315	G 1/8	6	26	34	19	12	14	17	1,95	FI-GA-08LR1/8-W3	
	8	315	G 1/4	6	31	39	24	17	19	17	3,91	FI-GA-08LR-W3	
	8	315	G 3/8	6	31	39	24	16	24	17	2,28	FI-GA-08LR3/8-W3	
	8	315	G 1/2	6	36	44	29	20	27	17	8,35	FI-GA-08LR1/2-W3	
	10	315	G 1/4	8	32	40	25	17	19	19	3,95	FI-GA-10LR-W3	
	10	315	G 3/8	8	32	40	25	16	24	19	4,94	FI-GA-10LR3/8-W3	
	10	315	G 1/2	8	37	45	30	20	27	19	8,36	FI-GA-10LR1/2-W3	
	12	315	G 1/4	8	33	41	26	17	19	22	4,44	FI-GA-12LR1/4-W3	
	12	315	G 3/8	10	33	41	26	17	24	22	6,43	FI-GA-12LR-W3	
	12	315	G 1/2	10	37	45	30	20	27	22	8,38	FI-GA-12LR1/2-W3	
	15	315	G 3/8	12	34	43	27	17	24	27	6,95	FI-GA-15LR3/8-W3	
	15	315	G 1/2	12	38	46	31	20	27	27	8,84	FI-GA-15LR-W3	
	15	315	G 3/4	12	38	46	31	20	30	27	19,13	FI-GA-15LR3/4-W3	
	18	315	G 3/8	15	34	43	26,5	20	27	32	9,61	FI-GA-18LR3/8-W3	
	18	315	G 1/2	15	38	47	30,5	20	27	32	9,15	FI-GA-18LR-W3	
	22	160	G 1/2	18,5	39	48,5	31,5	15,5	32	36	14,1	FI-GA-22LR1/2-W3	
	22	160	G 3/4	19	43	52	35,5	22	36	36	17,87	FI-GA-22LR-W3	
	22	160	G1	19	45,5	54,5	38	24,5	41	36	21,68	FI-GA-22LR1-W3	
	28	160	G 1	24	45,5	54,5	38	24,5	41	41	21,80	FI-GA-28LR-W3	
	35	160	G 1 1/4	30	51,5	62,5	41	26,5	55	50	47,49	FI-GA-35LR-W3	
	42	160	G 1 1/4	36	53,5	67	42,5	26,5	55	60	48,83	FI-GA-42LR1-1/4-W3	
	42	160	G 1 1/2	36	53,5	65,5	42,5	28,5	60	60	53,90	FI-GA-42LR-W3	

Connecting Parts

- Cutting Ring
Type **FI-DS** Page 28
- Soft-Sealing Cutting Ring
Type **FI-WDDS** Page 29
- Support Sleeve
Type **FI-VH** Page 31
- STAUFF Form EVO Sealing Ring
Type **FI-FD** Page 32
- Union Nut
Type **FI-M** Page 33
- 37° Flared Tube Fitting Set
Type **FI-AB** Page 37

¹ Approximate dimension in assembled condition.
² Weight excluding cutting ring and union nut.
³ Standard scope of delivery: Fitting body only.



**Straight Female Stud Fitting
Type FI-GA-...-R • Series S**

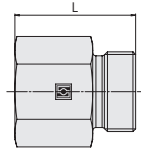
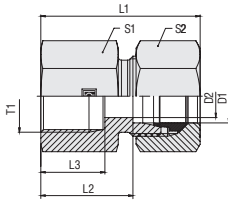

Female Whitworth Parallel Pipe Thread (BSPP)

Series	Tube OD mm D1	PN bar	Dimensions mm								Weight kg ca. per 100	Ordering Codes ³
			Thread T	D2	L	L1 ¹	L2	L3	S1	S2		
S	6	630	G 1/4	4	33	41	26	17	19	17	4,33	FI-GA-06SR-W3
	8	630	G 1/4	5	33	41	26	17	19	19	4,53	FI-GA-08SR-W3
	8	630	G 3/8	5	34	41,5	26,5	17	24	19	7	FI-GA-08SR3/8-W3
	10	630	G 1/4	7	33	43,5	25,5	17	19	22	4,68	FI-GA-10SR1/4-W3
	10	630	G 3/8	7	34	43	26,5	17	24	22	6,99	FI-GA-10SR-W3
	12	630	G 1/4	8	33	43,5	25,5	17	22	24	6,58	FI-GA-12SR1/4-W3
	12	630	G 3/8	8	34	43	26,5	17	24	24	7,08	FI-GA-12SR-W3
	12	630	G 1/2	8	38	47	30,5	20	27	24	9,23	FI-GA-12SR1/2-W3
	14	630	G 1/2	10	40	50	32	20	27	27	9,64	FI-GA-14SR-W3
	16	630	G 3/8	12	36	52	27,5	17	24	30	7,77	FI-GA-16SR3/8-W3
	16	630	G 1/2	12	40	50	31,5	20	27	30	9,70	FI-GA-16SR-W3
	20	400	G 3/4	16	45	56	34,5	22	36	36	19,50	FI-GA-20SR-W3
	25	400	G 3/4	20	47	59	35	22	41	46	28,74	FI-GA-25SR3/4-W3
	25	400	G 1	20	49,5	61,5	37,5	24,5	41	46	25,14	FI-GA-25SR-W3
	30	400	G 1 1/4	25	55,5	68,5	42	26,5	55	50	51,30	FI-GA-30SR-W3
	38	315	G 1 1/2	32	59,5	74,5	43,5	28,5	60	60	62,80	FI-GA-38SR-W3

¹ Approximate dimension in assembled condition.

² Weight excluding cutting ring and union nut.

³ Standard scope of delivery: Fitting body only.

Ordering Codes

***FI-GA*-10*S*R*-W3*-MS**

* Straight Female Stud Fitting	FI-GA
* Outside Tube Diameter D1 (in mm)	-10
* Series	Light Series (page 124) L Heavy Series (page 125) S
* Thread Type	Female Whitworth Parallel Pipe Thread (BSPP) R
If required, please indicate special sizes, e.g. R3/8!	
* Material Code	Steel, zinc/nickel-plated -W3
Please contact STAUFF for alternative materials and surface finishings.	
* Assembling / Kitting	Fitting body only —
	Fitting body supplied with cutting ring and union nut -MS
	Fitting body supplied with soft-sealing cutting ring and union nut -MSV

Connecting Parts

	Cutting Ring Type FI-DS	Page 28
	Soft-Sealing Cutting Ring Type FI-WDDS	Page 29
	Support Sleeve Type FI-VH	Page 31
	STAUFF Form EVO Sealing Ring Type FI-FD	Page 32
	Union Nut Type FI-M	Page 33
	37° Flared Tube Fitting Set Type FI-AB	Page 37



Straight Female Stud Fitting
Type FI-GA-...-M ▪ Series L / S

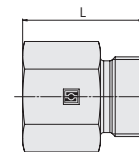
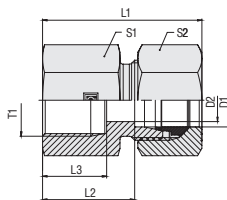

Female Metric Parallel Thread

Ordering Codes

***FI-GA*-10*L*M*-W3*-MS**

- * Straight Female Stud Fitting FI-GA
- * Outside Tube Diameter D1 (in mm) -10
- * Series L
Light Series
Heavy Series S
- * Thread Type M
Female Metric Parallel Thread
- If required, please indicate special sizes, e.g. M12x1.5!
- * Material Code -W3
Steel, zinc/nickel-plated
- Please contact STAUFF for alternative materials and surface finishings.
- * Assembling / Kitting —
Fitting body only
- Fitting body supplied with cutting ring and union nut -MS
- Fitting body supplied with soft-sealing cutting ring and union nut -MSV

Series	Tube OD mm D1	PN bar	Dimensions mm								Weight kg ca. per 100	Ordering Codes ³
			Thread	T	D2	L	L1 ¹	L2	L3	S1		
L	6	315	M10 x 1	4	26,5	34,5	19,5	12,5	14	14	1,89	FI-GA-06LM-W3
	8	315	M12 x 1,5	6	31	39	24	17	17	17	3,40	FI-GA-08LM-W3
	10	315	M14 x 1,5	8	32	40	25	17	19	19	3,73	FI-GA-10LM-W3
	12	315	M16 x 1,5	10	33	41	26	17	22	22	5,29	FI-GA-12LM-W3
	12	315	M18 x 1,5	10	33	42,5	26	17	24	22	6	FI-GA-12LM18x1.5-W3
	15	315	M18 x 1,5	12	35	43	28	17	24	27	6,77	FI-GA-15LM-W3
	18	315	M22 x 1,5	15	37	46	29,5	19	30	32	11,20	FI-GA-18LM-W3
	22	160	M26 x 1,5	19	42	51	34,5	21	32	36	12,42	FI-GA-22LM-W3
	28	160	M33 x 2	24	45	54	37,5	24	41	41	21,35	FI-GA-28LM-W3
	35	160	M42 x 2	30	51	62	40,5	26	55	50	46,20	FI-GA-35LM-W3
	42	160	M48 x 2	36	53	65	42	28	60	60	52,10	FI-GA-42LM-W3
	S	6	630	M12 x 1,5	4	33	41,5	26	17	17	17	3,49
8		630	M14 x 1,5	5	33	41	26	17	19	19	4,36	FI-GA-08SM-W3
10		630	M16 x 1,5	7	34	43	26,5	17	22	22	1,31	FI-GA-10SM-W3
12		630	M18 x 1,5	8	35	44	27,5	17	24	24	7,01	FI-GA-12SM-W3
14		630	M20 x 1,5	10	39	49	31	19	27	27	9,54	FI-GA-14SM-W3
16		630	M22 x 1,5	12	39	49	30,5	19	30	30	11,71	FI-GA-16SM-W3
20		400	M27 x 2	16	45	56	34,5	22	36	36	18,68	FI-GA-20SM-W3
25		400	M33 x 2	20	49	61	37	24	41	46	24,73	FI-GA-25SM-W3
30		400	M42 x 2	25	55	68	41,5	26	55	50	50,30	FI-GA-30SM-W3
38		400	M48 x 2	32	59	74	43	28	60	60	62,80	FI-GA-38SM-W3

¹ Approximate dimension in assembled condition.

² Weight excluding cutting ring and union nut.

³ Standard scope of delivery: Fitting body only.

Connecting Parts

- Cutting Ring
Type **FI-DS** Page 28
- Soft-Sealing Cutting Ring
Type **FI-WDDS** Page 29
- Support Sleeve
Type **FI-VH** Page 31
- STAUFF Form EVO Sealing Ring
Type **FI-FD** Page 32
- Union Nut
Type **FI-M** Page 33
- 37° Flared Tube Fitting Set
Type **FI-AB** Page 37



**Straight Female Stud Fitting
Type FI-GA-...-N • Series L / S**

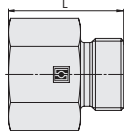
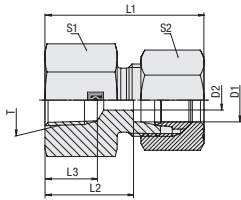

NPT Thread

Series	Tube OD mm	PN bar	Dimensions mm								Weight kg ca. per 100	Ordering Codes ³
			Thread T	D2	L	L1 ¹	L2	L3	S1	S2		
L	6	315	1/4 NPT	4	30,5	38	23,5	16,4	19	14	4,20	FI-GA-06L1/4N-W3
	8	315	1/4 NPT	6	30,5	38	23,5	16,4	19	17	4,30	FI-GA-08L1/4N-W3
	10	315	1/4 NPT	8	31	39	24,0	16,4	19	19	4,10	FI-GA-10L1/4N-W3
	12	315	3/8 NPT	10	34	42	27	20,8	24	22	6,6	FI-GA-12L3/8N-W3
	18	315	1/2 NPT	15	40	49	32	28,5	27	32	9,71	FI-GA-18L1/2N-W3
S	14	400	1/2 NPT	10	43	49	35	26	27	27	9,58	FI-GA-14S1/2N-W3
	16	400	1/2 NPT	12	43	50	34,5	22,6	27	30	11,70	FI-GA-16S1/2N-W3
	20	315	1/2 NPT	16	44	55	33,5	23,1	32	36	16,00	FI-GA-20S1/2N-W3
	20	315	3/4 NPT	16	46	57	35,5	23,1	36	36	20,29	FI-GA-20S3/4N-W3

¹ Approximate dimension in assembled condition.

² Weight excluding cutting ring and union nut.

³ Standard scope of delivery: Fitting body only.

Ordering Codes

***FI-GA*-10*L*1/4*N*-W3*-MS**

* Straight Female Stud Fitting	FI-GA
* Outside Tube Diameter D1 (in mm)	-10
* Series	Light Series L Heavy Series S
* Thread Size	acc. to dimension table 1/4
Please always indicate thread sizes, e.g. 1/4!	
* Thread Type	NPT Thread N
* Material Code	Steel, zinc/nickel-plated -W3
Please contact STAUFF for alternative materials and surface finishings.	
* Assembling / Kitting	Fitting body only —
	Fitting body supplied with cutting ring and union nut -MS
	Fitting body supplied with soft-sealing cutting ring and union nut -MSV

Connecting Parts

	Cutting Ring Type FI-DS	Page 28
	Soft-Sealing Cutting Ring Type FI-WDDS	Page 29
	Support Sleeve Type FI-VH	Page 31
	STAUFF Form EVO Sealing Ring Type FI-FD	Page 32
	Union Nut Type FI-M	Page 33
	37° Flared Tube Fitting Set Type FI-AB	Page 37

G



G

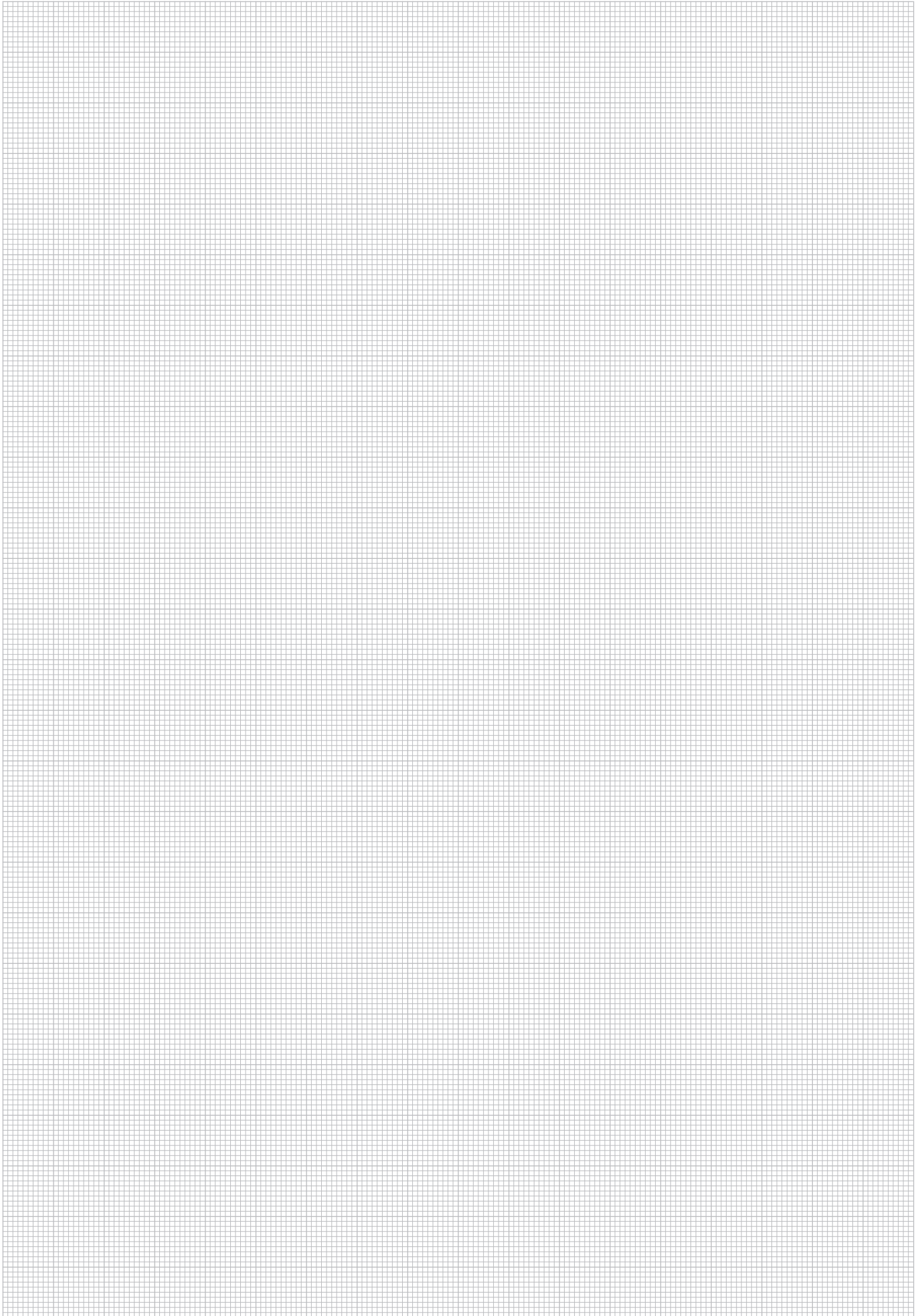

Gauge Fitting
Type FI-MA-...-R • Series L / S

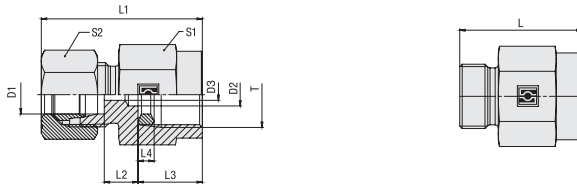

Internal Metallic Sealing Ring

Female Whitworth Parallel Pipe Thread (BSPP)

Series	Tube OD mm	PN bar	Dimensions mm											Weight kg ca. per 100	Ordering Codes ³
	D1		Thread T	D2	D3	L	L1 ¹	L2	L3	L4	S1	S2			
L	6	500	G 1/4	5,5	4	29	37	7,5	13	4,5	19	14	3,76	FI-MA-06LR-W3-DKI	
	8	500	G 1/4	5,5	5,5	29	37	7,5	14,5	4,5	19	17	3,74	FI-MA-08LR-W3-DKI	
	10	500	G 1/4	5,5	5,5	30	38	8,5	14,5	4,5	19	19	4,05	FI-MA-10LR-W3-DKI	
	12	400	G 1/4	5,5	5,5	30	38	8,5	14,5	4,5	19	22	4,31	FI-MA-12LR-W3-DKI	
S	6	800	G 1/2	7	4	38	46	11	20	5	27	17	9,16	FI-MA-06SR-W3-DKI	
	8	800	G 1/4	6	3,5	31	39	9,5	14,5	4,5	19	19	4,38	FI-MA-08SR1/4-W3-DKI	
	8	800	G 1/2	7	5	38	46	11	20	5	27	19	9,30	FI-MA-08SR-W3-DKI	
	10	800	G 1/2	7	3,5	38	47	10,5	20	5	27	22	9,39	FI-MA-10SR-W3-DKI	
	12	630	G 1/4	5,5	5,5	34	43,5	12	14,5	4,5	22	24	6,72	FI-MA-12SR1/4-W3-DKI	
	12	630	G 1/2	7	3,5	38	47	10,5	20	5	27	24	9,76	FI-MA-12SR-W3-DKI	

¹ Approx.imate dimension in assembled condition.

² Weight excluding cutting ring and union nut.

³ Standard scope of delivery: Fitting body only.

Ordering Codes

FI-MA-10*L*R*-W3*-DKI

* Gauge Fitting		FI-MA
* Outside Tube Diameter D1 (in mm)		-10
* Series	Light Series	L
	Heavy Series	S
* Thread Type	Female Whitworth Parallel Pipe Thread (BSPP)	R
If required, please indicate special sizes, e.g. R1/2!		
* Material Code	Steel, zinc/nickel-plated	-W3
Please contact STAUFF for alternative materials and surface finishings.		
* Internal Seal Type	Internal metallic sealing ring	-DKI
* Assembling / Kitting	Fitting body only	—
	Fitting body supplied with cutting ring and union nut	-MS
	Fitting body supplied with soft-sealing cutting ring and union nut	-MSV

Connecting Parts

	Cutting Ring Type FI-DS	Page 28
	Soft-Sealing Cutting Ring Type FI-WDDS	Page 29
	Support Sleeve Type FI-VH	Page 31
	STAUFF Form EVO Sealing Ring Type FI-FD	Page 32
	Union Nut Type FI-M	Page 33
	37° Flared Tube Fitting Set Type FI-AB	Page 37

Spare Parts / Accessories

	Internal Metallic Sealing Ring Type FI-DKI	Page 246
--	---	----------

G



Gauge Fitting with 24° Taper / O-Ring
Type FI-EMAD-...-R ▪ Series L / S

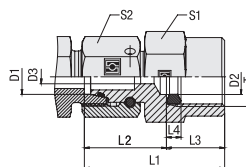

Female Whitworth Parallel Pipe Thread (BSPP)

Internal Metallic Sealing Ring

Ordering Codes

***FI-EMAD*-10*L*R*-V*-W3*-DKI-DKO**

- * Gauge Fitting with 24° Taper / O-Ring **FI-EMAD**
- * Outside Tube Diameter D1 (in mm) **-10**
- * Series **L**
Light Series
SHeavy Series
- * Thread Type **R**
Female Whitworth Parallel
Pipe Thread (BSPP)
- If required, please indicate special sizes, e.g. R1/2!
- * Seal Material **-V**
FKM (Viton®)
- * Material Code **-W3**
Steel, zinc/nickel-plated
- Please contact STAUFF for alternative materials and surface finishings.
- * Internal Seal Type **-DKI**
Internal metallic sealing ring
- * Assembling / Kitting **-DKO**
Fitting body supplied with swivel nut and O-ring

Series	Tube OD mm D1	PN bar	Dimensions mm										Weight kg ca. per 100	Ordering Codes
			Thread T	D2	D3	L1	L2	L3	L4	S1	S2			
L	6	500	G 1/4	5,5	3	38,5	24	14,5	4,5	19	14	6,34	FI-EMAD-06LR-V-W3-DKI-DKO	
	8	500	G 1/4	5,5	3	38,5	24	14,5	4,5	19	17	6,16	FI-EMAD-08LR-V-W3-DKI-DKO	
	10	500	G 1/4	5,5	3,5	39,5	25	14,5	4,5	19	19	7,22	FI-EMAD-10LR-V-W3-DKI-DKO	
	12	315	G 1/4	5,5	3,5	41	26,5	14,5	4,5	19	22	8,48	FI-EMAD-12LR-V-W3-DKI-DKO	
S	12	315	G 1/2	7	3,5	44,5	24,5	20	5	27	22	12,8	FI-EMAD-12LR1/2-V-W3-DKI-DKO	
	6	630	G 1/4	5,5	3,0	38	23,5	14,5	4,5	19	17	6,08	FI-EMAD-06SR1/4-V-W3-DKI-DKO	
	6	630	G 1/2	7	3	45	25	20	5	27	17	11,49	FI-EMAD-06SR-V-W3-DKI-DKO	
	8	630	G 1/4	5,5	3,5	38	24	14,5	4,5	19	19	6,55	FI-EMAD-08SR1/4-V-W3-DKI-DKO	
	8	630	G 1/2	7	3,5	43,5	23,5	20	5	27	19	10,87	FI-EMAD-08SR-V-W3-DKI-DKO	
	10	630	G 1/4	5,5	3,5	39,5	25	14,5	4,5	19	22	7,66	FI-EMAD-10SR1/4-V-W3-DKI-DKO	
	10	630	G 1/2	7	3,5	44	24	20	5	27	22	12,19	FI-EMAD-10SR-V-W3-DKI-DKO	
	12	630	G 1/4	5,5	3,5	40	25,5	14,5	4,5	19	24	9,40	FI-EMAD-12SR1/4-V-W3-DKI-DKO	
12	630	G 1/2	7	3,5	45,5	25,5	20	5	27	24	13,98	FI-EMAD-12SR-V-W3-DKI-DKO		

Standard seal material is FKM (Viton®).

Spare Parts / Accessories



O-Ring
Type **O-RING** Page 239



Internal Metallic Sealing Ring
Type **FI-DKI** Page 246



Gauge Standpipe Fitting
Type FI-EMA-...-R ▪ Series L / S

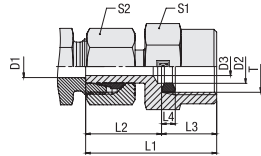

Internal Metallic Sealing Ring

Female Whitworth Parallel Pipe Thread (BSPP)

Series	Tube OD mm D1	PN bar	Dimensions mm Thread T	D2	D3	L1	L2	L3	L4	S1	S2	Weight kg ca. per 100 ¹	Ordering Codes
L	6	315	G 1/4	5,5	3,3	38	23,5	14,5	4,5	19	14	4,65	FI-EMA-06LR-W3-DKI-SV
	8	315	G 1/4	5,5	3,5	38	23,5	14,5	4,5	19	17	5,53	FI-EMA-08LR-W3-DKI-SV
	10	315	G 1/4	5,5	3,5	39,5	25	14,5	4,5	19	19	6,40	FI-EMA-10LR-W3-DKI-SV
	12	315	G 1/4	5,5	3,5	40,5	26	14,5	4,5	19	22	8,01	FI-EMA-12LR-W3-DKI-SV
	12	315	G 1/2	12	5,5	46,5	26,5	20	5	27	22	11,89	FI-EMA-12LR1/2-W3-DKI-SV
S	6	630	G 1/2	7	3,5	45	25	20	5	27	17	10,73	FI-EMA-06SR-W3-DKI-SV
	8	630	G 1/2	7	3,5	45	25	20	5	27	19	10,95	FI-EMA-08SR-W3-DKI-SV
	10	630	G 1/2	7	3,5	47	27	20	5	27	22	12,15	FI-EMA-10SR-W3-DKI-SV
	12	630	G 1/4	5,5	3,5	40,2	25,7	14,5	4,5	19	24	8,78	FI-EMA-12SR1/4-W3-DKI-SV
	12	630	G 1/2	7	3,5	47,5	27,5	20	5	27	24	13,43	FI-EMA-12SR-W3-DKI-SV

¹Weight including cutting ring and union nut.

Please note: Standpipes are always factory-assembled with cutting rings and union nuts.

The union nut assembled on the standpipe has to be tightened by only 1/12 a turn (equivalent to 30°) beyond the fixed point.

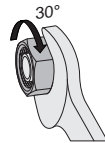

Ordering Codes

***FI-EMA*-10*L*R*-W3*-DKI-SV**

* Gauge Standpipe Fitting		FI-EMA
* Outside Tube Diameter D1 (in mm)		-10
* Series	Light Series	L
	Heavy Series	S
* Thread Type	Female Whitworth Parallel Pipe Thread (BSPP)	R
If required, please indicate special sizes, e.g. R1/2!		
* Material Code	Steel, zinc/nickel-plated	-W3
Please contact STAUFF for alternative materials and surface finishings.		
* Internal Seal Type	Internal metallic sealing ring	-DKI
* Assembling / Kitting	Standpipe factory-assembled with cutting ring and union nut	-SV

Spare Parts / Accessories



Internal Metallic Sealing Ring
Type FI-DKI Page 246



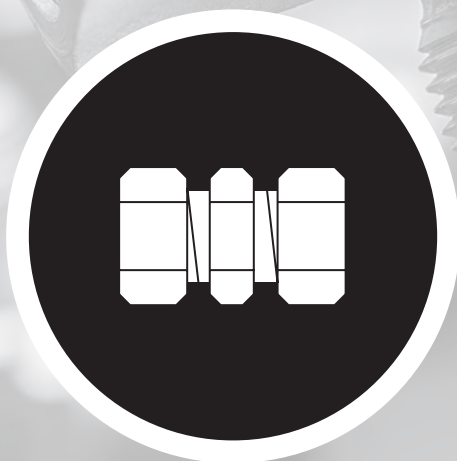
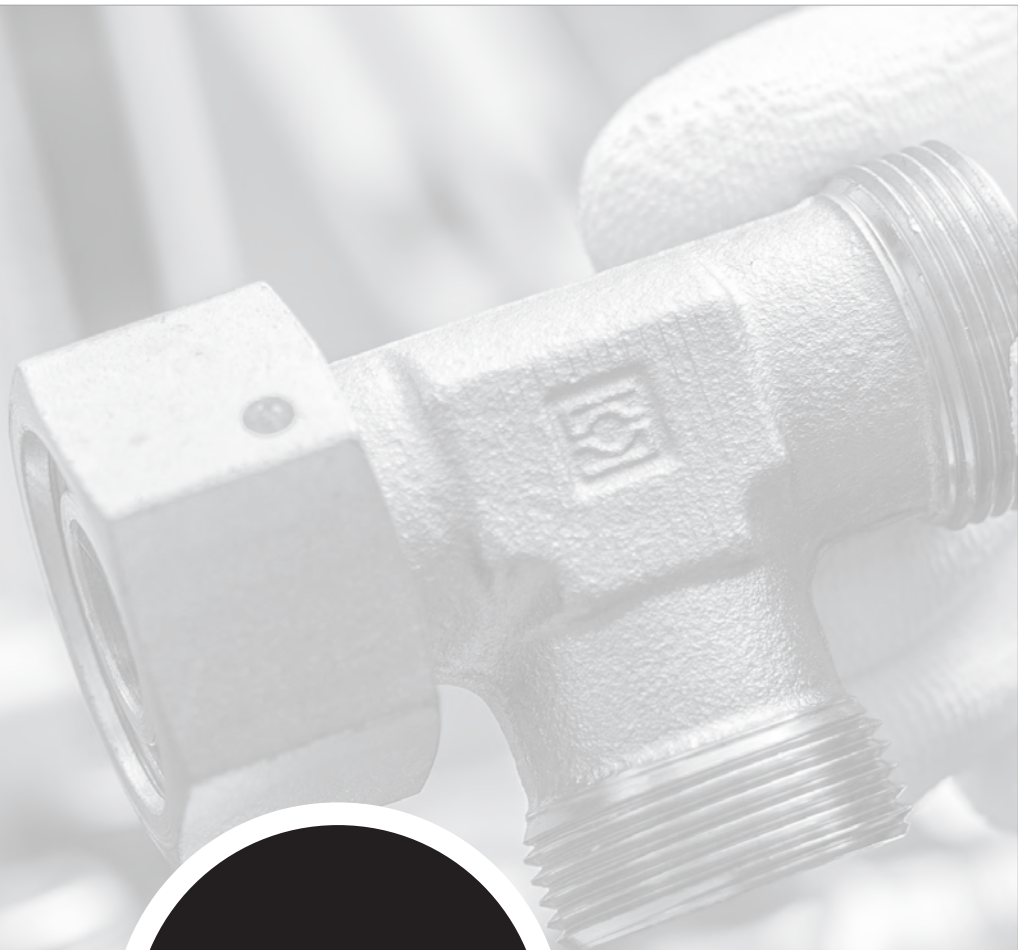

	Straight Male Stud Fitting with 24° Taper / O-Ring FI-EGED	134-137
	Whitworth Parallel Pipe Thread (BSPP) / Profile Sealing Ring FI-EGED-...-R-WD	134
	Metric Parallel Thread / Profile Sealing Ring FI-EGED-...-M-WD	136
	NPT Thread FI-EGED-...-N	137
	Straight Fitting with 24° Taper / O-Ring FI-SNV	138
	Straight Reducer with 24° Taper / O-Ring FI-SNV	140
	Straight Reducer for Tube Ends with 24° Taper / O-Ring FI-RESD	144
	Distance Adaptors with 24° Taper / O-Ring FI-RESD	148
	Adjustable Elbow (90°) with 24° Taper / O-Ring FI-EWD	150
	Adjustable Elbow (45°) with 24° Taper / O-Ring FI-EVD	151
	Adjustable Branch Tee with 24° Taper / O-Ring FI-ETD	152
	Adjustable Barrel Tee with 24° Taper / O-Ring FI-ELD	153



Straight Male Stud Fitting with 24° Taper / O-Ring Type FI-EGED-...-R-WD ▪ Series L

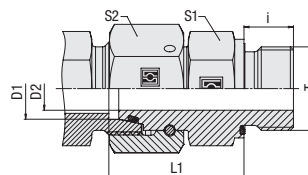

Whitworth Parallel Pipe Thread (BSPP)

Profile Sealing Ring

Ordering Codes

***FI-EGED*-10*L*R*-WD*-BV*-W3*-DKO**

* Straight Male Stud Fitting with 24° Taper / O-Ring (DKO) **FI-EGED**

* Outside Tube Diameter D1 (in mm) **-10**

* Series Light Series (page 134) **L**
Heavy Series (page 135) **S**

* Thread Type Whitworth Parallel Pipe Thread (BSPP) **R**

If required, please indicate special sizes, e.g. R3/8!

* Seal Type Profile Sealing Ring **-WD**

* Seal Material Male Stud: NBR (Buna-N®) **-BV**
24° Taper: FKM (Viton®)
FKM (Viton®) **-V**

* Material Code Steel, zinc/nickel-plated **-W3**

Please contact STAUFF for alternative materials and surface finishings.

* Assembling / Kitting Fitting body supplied with swivel nut and O-ring **-DKO**

Series	Tube OD mm D1	PN bar	Dimensions mm						Torque N-m Thread T	Weight kg ca. per 100	Ordering Codes
			Thread T	D2	i	L1	S1	S2			
L	6	500	G 1/8	2,5	8	24,5	14	14	18	3,74	FI-EGED-06LR-WD-BV-W3-DKO
	6	500	G 1/4	2,5	12	27,5	19	14	35	5,42	FI-EGED-06LR1/4-WD-BV-W3-DKO
	8	500	G 1/8	4	8	25,5	14	17	18	3,96	FI-EGED-08LR1/8-WD-BV-W3-DKO
	8	500	G 1/4	4	12	29,5	19	17	35	5,23	FI-EGED-08LR-WD-BV-W3-DKO
	8	400	G 3/8	5	12	28,5	22	17	70	7,16	FI-EGED-08LR3/8-WD-BV-W3-DKO
	10	500	G 1/4	6	12	27,5	19	19	35	5,68	FI-EGED-10LR-WD-BV-W3-DKO
	10	400	G 3/8	6,5	12	34,5	22	19	70	7,69	FI-EGED-10LR3/8-WD-BV-W3-DKO
	10	400	G 1/2	6,5	14	36	27	19	90	13,5	FI-EGED-10LR1/2-WD-BV-W3-DKO
	12	500	G 1/4	6	12	28	19	22	35	7,02	FI-EGED-12LR1/4-WD-BV-W3-DKO
	12	400	G 3/8	8	12	34	22	22	70	9,78	FI-EGED-12LR-WD-BV-W3-DKO
	12	400	G 1/2	8	14	29,5	27	22	90	11,71	FI-EGED-12LR1/2-WD-BV-W3-DKO
	15	400	G 3/8	9	12	31,5	22	27	70	10,74	FI-EGED-15LR3/8-WD-BV-W3-DKO
	15	400	G 1/2	10	14	32	27	27	90	13,70	FI-EGED-15LR-WD-BV-W3-DKO
	15	250	G 3/4	11	16	31	32	27	180	14,89	FI-EGED-15LR3/4-WD-BV-W3-DKO
	18	400	G 1/2	13	14	31,5	27	32	90	14,86	FI-EGED-18LR-WD-BV-W3-DKO
	18	250	G 3/4	13	16	31	32	32	180	17,92	FI-EGED-18LR3/4-WD-BV-W3-DKO
	22	250	G 1/2	17	14	34,5	32	36	90	19	FI-EGED-22LR1/2-WD-BV-W3-DKO
	22	250	G 3/4	17	16	32,5	32	36	180	20,98	FI-EGED-22LR-WD-BV-W3-DKO
	22	250	G 1	17	18	34,5	41	36	310	31,66	FI-EGED-22LR1-WD-BV-W3-DKO
	28	250	G 3/4	23	16	35	36	41	180	22,99	FI-EGED-28LR3/4-WD-BV-W3-DKO
	28	250	G 1	22	18	35	41	41	310	22,78	FI-EGED-28LR-WD-BV-W3-DKO
	35	250	G 1 1/4	28	20	42,5	50	50	450	51,00	FI-EGED-35LR-WD-BV-W3-DKO
	35	250	G 1 1/2	28	22	46,5	55	50	540	61,3	FI-EGED-35LR1-1/2-WD-BV-W3-DKO
	42	250	G 1 1/4	35	20	47	55	60	450	62,8	FI-EGED-42LR1-1/4-WD-BV-W3-DKO
	42	250	G 1 1/2	34	22	46,5	55	60	540	68,60	FI-EGED-42LR-WD-BV-W3-DKO

Spare Parts / Accessories



O-Ring
Type **O-RING** Page 239



Profile Sealing Ring
Type **WDG** Page 238

Standard seal material: See Ordering Code BV.

Male threaded studs were designed for female threaded ports in components made of steel. For applications with components made of softer mating materials (e.g. Aluminium), the use of connectors with additionally rolled male threads is recommended.

Please contact STAUFF prior to the assembly for further information.

Male stud acc. to ISO 1179-2 (Type E)
Port acc. to ISO 1179-1

Torque recommendations for Steel mating material.

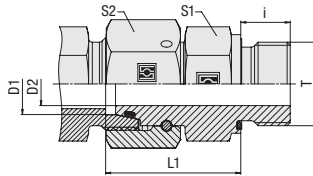

**Straight Male Stud Fitting with 24° Taper / O-Ring
Type FI-EGED-...-R-WD ■ Series S**

Whitworth Parallel Pipe Thread (BSPP)
Profile Sealing Ring

Series	Tube OD mm D1	PN bar	Dimensions mm Thread T	D2	i	L1	S1	S2	Torque N-m Thread T	Weight kg ca. per 100	Ordering Codes
S	6	800	G 1/4	2,5	12	27	19	17	55	5,55	FI-EGED-06SR-WD-BV-W3-DKO
	8	800	G 1/4	4	12	29,5	19	19	55	6,52	FI-EGED-08SR-WD-BV-W3-DKO
	8	800	G 3/8	4	12	32	22	19	80	8,25	FI-EGED-08SR3/8-WD-BV-W3-DKO
	10	800	G 1/4	6	12	29,5	19	22	55	7,19	FI-EGED-10SR1/4-WD-BV-W3-DKO
	10	800	G 3/8	6	12	32	22	22	80	9,63	FI-EGED-10SR-WD-BV-W3-DKO
	12	630	G 1/4	5	12	33	19	24	55	9,05	FI-EGED-12SR1/4-WD-BV-W3-DKO
	12	630	G 3/8	8	12	34	22	24	80	7,03	FI-EGED-12SR-WD-BV-W3-DKO
	12	630	G 1/2	8	14	36	27	24	115	6,36	FI-EGED-12SR1/2-WD-BV-W3-DKO
	14	630	G 1/2	9	14	37	27	27	115	14,39	FI-EGED-14SR-WD-BV-W3-DKO
	16	630	G 3/8	8	12	37,5	27	30	80	16,88	FI-EGED-16SR3/8-WD-BV-W3-DKO
	16	630	G 1/2	11	14	37	27	30	115	17,03	FI-EGED-16SR-WD-BV-W3-DKO
	16	420	G 3/4	11	16	39,5	32	30	180	23,9	FI-EGED-16SR3/4-WD-BV-W3-DKO
	20	420	G 1/2	12	14	40,5	27	36	115	22,47	FI-EGED-20SR1/2-WD-BV-W3-DKO
	20	420	G 3/4	14	16	43	32	36	180	27,34	FI-EGED-20SR-WD-BV-W3-DKO
	25	420	G 3/4	17	16	49	36	46	180	42,11	FI-EGED-25SR3/4-WD-BV-W3-DKO
	25	420	G 1	18	18	48	41	46	310	50,20	FI-EGED-25SR-WD-BV-W3-DKO
	30	420	G 1 1/4	23	20	51	50	50	450	70,40	FI-EGED-30SR-WD-BV-W3-DKO
	30	420	G 1 1/2	22	22	53,5	55	50	540	83,5	FI-EGED-30SR1-1/2-WD-BV-W3-DKO
	30	420	G 1	20	18	50,5	41	50	310	54,7	FI-EGED-30SR1-WD-BV-W3-DKO
	38	420	G 1 1/4	30	20	56	55	60	450	92,4	FI-EGED-38SR1-1/4-WD-BV-W3-DKO
	38	420	G 1 1/2	30	22	60	55	60	540	93,50	FI-EGED-38SR-WD-BV-W3-DKO

Standard seal material: See Ordering Code BV.

Male threaded studs were designed for female threaded ports in components made of steel. For applications with components made of softer mating materials (e.g. Aluminium), the use of connectors with additionally rolled male threads is recommended.

Please contact STAUFF prior to the assembly for further information.

Male stud acc. to ISO 1179-2 (Type E)
Port acc. to ISO 1179-1

Torque recommendations for Steel mating material.

Ordering Codes
***FI-EGED*-10*S*R*-WD*-BV*-W3*-DKO**

- * Straight Male Stud Fitting with 24° Taper / O-Ring (DKO) FI-EGED
- * Outside Tube Diameter D1 (in mm) -10
- * Series Light Series (page 134) L
Heavy Series (page 135) S
- * Thread Type Whitworth Parallel Pipe Thread (BSPP) R
- If required, please indicate special sizes, e.g. R3/8!
- * Seal Type Profile Sealing Ring -WD
- * Seal Material Male Stud: NBR (Buna-N®) -BV
24° Taper: FKM (Viton®) -V
- * Material Code Steel, zinc/nickel-plated -W3
- Please contact STAUFF for alternative materials and surface finishings.
- * Assembling / Kitting Fitting body supplied with swivel nut and O-ring -DKO

Spare Parts / Accessories

- O-Ring
Type **O-RING** Page 239
- Profile Sealing Ring
Type **WDG** Page 238



Straight Male Stud Fitting with 24° Taper / O-Ring Type FI-EGED-...-M-WD ▪ Series L / S

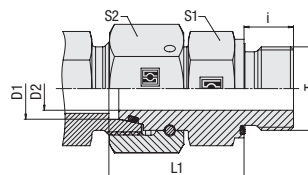

Profile Sealing Ring

Metric Parallel Thread

Ordering Codes

***FI-EGED*-10*L*M*-WD*-BV*-W3*-DKO**

* Straight Male Stud Fitting with 24° Taper / O-Ring (DKO) **FI-EGED**

* Outside Tube Diameter D1 (in mm) **-10**

* Series Light Series **L**
Heavy Series **S**

* Thread Type Metric Parallel Thread **M**

If required, please indicate special sizes, e.g. M12x1.5!

* Seal Type Profile Sealing Ring **-WD**

* Seal Material Male Stud: NBR (Buna-N®) **-BV**
24° Taper: FKM (Viton®) **-V**
FKM (Viton®)

* Material Code Steel, zinc/nickel-plated **-W3**

Please contact STAUFF for alternative materials and surface finishings.

* Assembling / Kitting Fitting body supplied with swivel nut and O-ring **-DKO**

Series	Tube OD mm D1	PN bar	Dimensions mm						Torque N-m Thread T	Weight kg ca. per 100	Ordering Codes
			Thread T	D2	i	L1	S1	S2			
L	6	500	M10x1	2,5	8	24,5	14	14	18	3,76	FI-EGED-06LM-WD-BV-W3-DKO
	8	500	M12x1,5	4	12	26,5	17	17	25	4,64	FI-EGED-08LM-WD-BV-W3-DKO
	10	500	M14x1,5	6	12	27,5	19	19	45	5,97	FI-EGED-10LM-WD-BV-W3-DKO
	12	400	M16x1,5	8	12	30,5	22	22	55	9,58	FI-EGED-12LM-WD-BV-W3-DKO
	12	400	M18x1,5	8	12	31	24	22	70	9,78	FI-EGED-12LM18x1.5-WD-BV-W3-DKO
	12	400	M22x1,5	8	14	29	27	22	125	10,12	FI-EGED-12LM22x1.5-WD-BV-W3-DKO
	15	400	M18x1,5	10	12	31,5	24	27	70	12,62	FI-EGED-15LM-WD-BV-W3-DKO
	15	400	M22x1,5	11	14	34	27	27	125	14,26	FI-EGED-15LM22x1.5-WD-BV-W3-DKO
	18	400	M22x1,5	13	14	31,5	27	32	125	15,28	FI-EGED-18LM-WD-BV-W3-DKO
	22	250	M26x1,5	17	16	32,5	32	36	180	20,75	FI-EGED-22LM-WD-BV-W3-DKO
	28	250	M33x2	22	18	35	41	41	310	28,61	FI-EGED-28LM-WD-BV-W3-DKO
	35	250	M42x2	28	20	42,5	50	50	450	52,30	FI-EGED-35LM-WD-BV-W3-DKO
	42	250	M48x2	34	22	46,5	55	60	540	72,56	FI-EGED-42LM-WD-BV-W3-DKO
	S	6	800	M12x1,5	2,5	12	27	17	17	35	4,88
8		800	M14x1,5	4	12	29,5	19	19	55	6,59	FI-EGED-08SM-WD-BV-W3-DKO
10		800	M16x1,5	6	12	32	22	22	70	9,34	FI-EGED-10SM-WD-BV-W3-DKO
12		630	M18x1,5	8	12	34	24	24	90	10,44	FI-EGED-12SM-WD-BV-W3-DKO
14		630	M20x1,5	9	14	36,5	27	27	125	16,00	FI-EGED-14SM-WD-BV-W3-DKO
16		630	M22x1,5	11	14	37	27	30	135	17,32	FI-EGED-16SM-WD-BV-W3-DKO
20		420	M27x2	14	16	43	32	36	180	27,99	FI-EGED-20SM-WD-BV-W3-DKO
25		420	M33x2	18	18	48	41	46	310	50,00	FI-EGED-25SM-WD-BV-W3-DKO
30		420	M42x2	23	20	51	50	50	450	70,30	FI-EGED-30SM-WD-BV-W3-DKO
38		420	M48x2	30	22	60	55	60	540	94,50	FI-EGED-38SM-WD-BV-W3-DKO

Spare Parts / Accessories



O-Ring
Type **O-RING** Page 239



Profile Sealing Ring
Type **WDG** Page 238

Standard seal material: See Ordering Code BV.

Male threaded studs were designed for female threaded ports in components made of steel. For applications with components made of softer mating materials (e.g. Aluminium), the use of connectors with additionally rolled male threads is recommended.

Please contact STAUFF prior to the assembly for further information.

Male stud acc. to ISO 9974-2 (Type E)

Port acc. to ISO 9974-1

Torque recommendations for Steel mating material.



**Straight Male Stud Fitting with 24° Taper / O-Ring
Type FI-EGED-...-N • Series L / S**

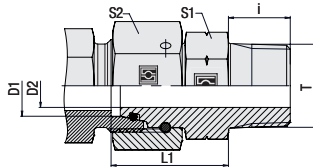

NPT Thread

Series	Tube OD mm	PN bar	Dimensions mm							Weight kg ca. per 100	Ordering Codes
			Thread T	D2	i	L1	S1	S2			
L	6	315	1/8 NPT	3	10	33	14	14	3,75	FI-EGED-06L1/8N-V-W3-DKO	
	8	315	1/4 NPT	5	15	41,5	14	17	4,53	FI-EGED-08L1/4N-V-W3-DKO	
	10	315	1/4 NPT	6,5	15	41,5	17	19	5,34	FI-EGED-10L1/4N-V-W3-DKO	
	12	315	3/8 NPT	8	15	46	19	22	8,42	FI-EGED-12L3/8N-V-W3-DKO	
	15	315	1/2 NPT	11	20	50	22	27	12,06	FI-EGED-15L1/2N-V-W3-DKO	
	18	315	1/2 NPT	12	20	48	27	32	15,73	FI-EGED-18L1/2N-V-W3-DKO	
	22	160	3/4 NPT	17	20	51	30	36	20,22	FI-EGED-22L3/4N-V-W3-DKO	
	28	160	1 NPT	23	25	60	41	41	29,5	FI-EGED-28L1N-V-W3-DKO	
	35	160	1 1/4 NPT	28	26	66,5	50	50	53,2	FI-EGED-35L1-1/4N-V-W3-DKO	
	42	160	1 1/2 NPT	35	26	70	55	66	69,45	FI-EGED-42L1-1/2N-V-W3-DKO	
S	6	630	1/4 NPT	3	15	42	17	17	4,2	FI-EGED-06S1/4N-V-W3-DKO	
	8	630	1/4 NPT	4	15	43	17	19	5,94	FI-EGED-08S1/4N-V-W3-DKO	
	10	630	3/8 NPT	6,5	15	44,5	19	22	8,42	FI-EGED-10S3/8N-V-W3-DKO	
	12	630	3/8 NPT	8	15	47	19	24	9,34	FI-EGED-12S3/8N-V-W3-DKO	
	14	630	1/2 NPT	9	20	54	24	27	15,1	FI-EGED-14S1/2N-V-W3-DKO	
	16	400	1/2 NPT	11	20	54	24	27	15,63	FI-EGED-16S1/2N-V-W3-DKO	
	20	400	3/4 NPT	14	20	57	30	36	25,5	FI-EGED-20S3/4N-V-W3-DKO	
	25	400	1 NPT	18	25	67	36	46	44,71	FI-EGED-25S1N-V-W3-DKO	
	30	400	1 1/4 NPT	22	26	71	50	50	72,11	FI-EGED-30S1-1/4N-V-W3-DKO	
	38	315	1 1/2 NPT	30	26	79	55	60	95	FI-EGED-38S1-1/2N-V-W3-DKO	

Ordering Codes

***FI-EGED*-10*L*1/4*N*-V*-W3*-DKO**

- * Straight Male Stud Fitting with 24° Taper / O-Ring (DKO) FI-EGED
- * Outside Tube Diameter D1 (in mm) -10
- * Series Light Series L
Heavy Series S
- * Thread Size acc. to dimension table 1/4
- Please always indicate thread sizes, e.g. 1/4!
- * Thread Type NPT Thread N
- * Seal Material FKM (Viton®) -V
- * Material Code Steel, zinc/nickel-plated -W3
- Please contact STAUFF for alternative materials and surface finishings.
- * Assembling / Kitting Fitting body supplied with swivel nut and O-ring -DKO

Standard seal material: See Ordering Code V.

Male stud acc. to ANSI/ASME B1.20.1-1983
Port acc. to ANSI/ASME B1.20.1-1983

Male threaded studs were designed for female threaded ports in components made of steel. For applications with components made of softer mating materials (e.g. Aluminium), the use of connectors with additionally rolled male threads is recommended.

Suitable liquid / plastic sealant required.

Please contact STAUFF prior to the assembly for further information.

Torque recommendations for Steel mating material.

Spare Parts / Accessories



O-Ring
Type **O-RING**

Page 239



**Straight Fitting with 24° Taper / O-Ring
Type FI-SNV • Series L**

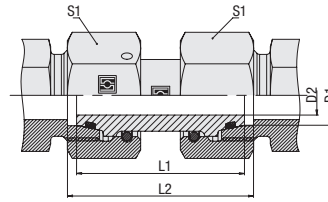

Ordering Codes

***FI-SNV*-10*L*-V*-W3*-DKO**

- * Straight Fitting with 24° Taper / O-Ring (DKO) **FI-SNV**
- * Outside Tube Diameter D1 (in mm) **-10**
- * Series **L**
Light Series (page 138) **S**
Heavy Series (page 139)
- * Seal Material **-V**
FKM (Viton®)
- * Material Code **-W3**
Steel, zinc/nickel-plated
- Please contact STAUFF for alternative materials and surface finishings.
- * Assembling / Kitting **-DKO**
Fitting body supplied with swivel nuts and O-rings
- * Total length **-GLA**
dimension see table **-GLB**
dimension see table

Spare Parts / Accessories



O-Ring
Type **O-RING**

Page 239

Series	Tube OD mm D1	PN bar	Dimensions mm				Weight kg ca. per 100	Ordering Codes
			D2	L1	L2	S1		
L	6	500	3	30,8	33,5	14	2,81	FI-SNV-06L-V-W3-DKO-GLB
	6	500	3	34	36,7	14	3,82	FI-SNV-06L-V-W3-DKO
	6	500	3	36,3	39	14	2,99	FI-SNV-06L-V-W3-DKO-GLA
	8	500	5	30,8	33,5	17	4,19	FI-SNV-08L-V-W3-DKO-GLB
	8	500	5	34	36,7	17	4,29	FI-SNV-08L-V-W3-DKO
	8	500	5	36,8	39,5	17	4,45	FI-SNV-08L-V-W3-DKO-GLA
	10	500	6	32,2	34	19	5,56	FI-SNV-10L-V-W3-DKO-GLB
	10	500	6	36	37,8	19	5,78	FI-SNV-10L-V-W3-DKO
	10	500	6	37,7	39,5	19	6	FI-SNV-10L-V-W3-DKO-GLA
	12	400	8	32,2	34	22	7,5	FI-SNV-12L-V-W3-DKO-GLB
	12	400	8	36	37,8	22	7	FI-SNV-12L-V-W3-DKO
	12	400	8	39,5	41,3	22	8,04	FI-SNV-12L-V-W3-DKO-GLA
	15	400	11	39	40,8	27	12,58	FI-SNV-15L-V-W3-DKO
	15	400	11	40,7	42,5	27	12,62	FI-SNV-15L-V-W3-DKO-GLA
	18	400	13	36,2	39	32	17	FI-SNV-18L-V-W3-DKO-GLB
	18	400	13	40,5	43,3	32	17,59	FI-SNV-18L-V-W3-DKO
	18	400	13	42,2	45	32	18,16	FI-SNV-18L-V-W3-DKO-GLA
	22	250	17	41,2	44	36	24,12	FI-SNV-22L-V-W3-DKO-GLB
	22	250	17	45	47,8	36	24,91	FI-SNV-22L-V-W3-DKO
	22	250	17	46,7	49,5	36	25,4	FI-SNV-22L-V-W3-DKO-GLA
28	250	23	46	48,8	41	27,4	FI-SNV-28L-V-W3-DKO	
28	250	23	48,7	51,5	41	28,57	FI-SNV-28L-V-W3-DKO-GLA	
35	250	28	46	52	50	43,36	FI-SNV-35L-V-W3-DKO-GLB	
35	250	28	53	59	50	45,98	FI-SNV-35L-V-W3-DKO	
35	250	28	55	61	50	47,1	FI-SNV-35L-V-W3-DKO-GLA	
42	250	35	53	60	60	69,5	FI-SNV-42L-V-W3-DKO	
42	250	34	55,5	62,5	60	71,5	FI-SNV-42L-V-W3-DKO-GLA	

Standard seal material is FKM (Viton®).

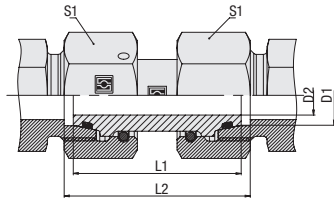

**Straight Fitting with 24° Taper / O-Ring
Type FI-SNV ▪ Series S**

Series	Tube OD	PN	Dimensions				Weight	Ordering Codes
	mm		mm	mm	mm	mm		
S	D1	bar	D2	L1	L2	S1	per 100	
	6	800	3	30,3	33	17	4,21	FI-SNV-06S-V-W3-DKO-GLB
	6	800	3	37	39,7	17	4,52	FI-SNV-06S-V-W3-DKO
	6	800	3	37,8	40,5	17	0,46	FI-SNV-06S-V-W3-DKO-GLA
	8	800	4	31,3	34	19	5,63	FI-SNV-08S-V-W3-DKO-GLB
	8	800	4	37	39,7	19	6,03	FI-SNV-08S-V-W3-DKO
	8	800	4	37,8	40,5	19	6,13	FI-SNV-08S-V-W3-DKO-GLA
	10	800	6	32,2	35	22	7,63	FI-SNV-10S-V-W3-DKO-GLB
	10	800	6	41	43,8	22	8,39	FI-SNV-10S-V-W3-DKO
	12	630	8	35,2	38	24	6,52	FI-SNV-12S-V-W3-DKO-GLB
	12	630	8	42	44,8	24	10,51	FI-SNV-12S-V-W3-DKO
	14	630	9	37,2	41	27	2,9	FI-SNV-14S-V-W3-DKO-GLB
	14	630	9	45	48,8	27	13,9	FI-SNV-14S-V-W3-DKO
	16	630	10	37,2	42	30	16,09	FI-SNV-16S-V-W3-DKO-GLB
	16	630	10	46	50,8	30	17,57	FI-SNV-16S-V-W3-DKO
	20	420	13	42	48	36	26,3	FI-SNV-20S-V-W3-DKO-GLB
	20	420	13	55	61	36	24,36	FI-SNV-20S-V-W3-DKO
	25	420	18	45,5	54,4	46	45,05	FI-SNV-25S-V-W3-DKO-GLB
	25	420	18	56,5	65,4	46	50,1	FI-SNV-25S-V-W3-DKO-GLA
	25	420	18	58	67	46	49,45	FI-SNV-25S-V-W3-DKO
	30	420	20	50	62	50	57,2	FI-SNV-30S-V-W3-DKO-GLB
	30	420	20	62	74	50	61,4	FI-SNV-30S-V-W3-DKO
	38	420	30	50	67	60	74,2	FI-SNV-38S-V-W3-DKO-GLB
	38	420	30	67	84	60	86,7	FI-SNV-38S-V-W3-DKO

Standard seal material is FKM (Viton®).

Ordering Codes
***FI-SNV*-10*S*-V*-W3*-DKO**

* Straight Fitting with 24° Taper / O-Ring (DKO)		FI-SNV
* Outside Tube Diameter D1 (in mm)		-10
* Series	Light Series (page 138) Heavy Series (page 139)	L S
* Seal Material	FKM (Viton®)	-V
* Material Code	Steel, zinc/nickel-plated	-W3
Please contact STAUFF for alternative materials and surface finishings.		
* Assembling / Kitting	Fitting body supplied with swivel nuts and O-rings	-DKO
* Total length	dimension see table	-GLA
	dimension see table	-GLB

Spare Parts / Accessories

O-Ring
Type **O-RING**

Page 239



**Straight Reducer with 24° Taper / O-Ring
Type FI-SNV • Series L**

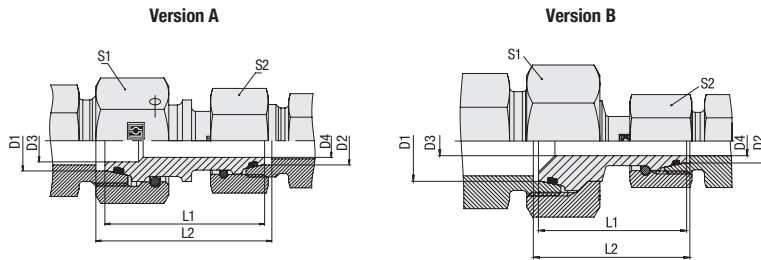

Ordering Codes

***FI-SNV*-10/*08*L*-V*-W3*-DKO**

- * Straight Reducer with 24° Taper / O-Ring (DKO) **FI-SNV**
- * Outside Tube Diameter D1 (in mm) **-10**
- * Outside Tube Diameter D2 (in mm) **08**
- * Series **L**
Light Series (pages 140/141)
Heavy Series (page 142) **S**
- * Seal Material **-V**
FKM (Viton®)
- * Material Code **-W3**
Steel, zinc/nickel-plated
- Please contact STAUFF for alternative materials and surface finishings.
- * Assembling / Kitting **-DKO**
Fitting body supplied with swivel nuts and O-rings
- * Total length **-GLB**
dimension see table

Series	Tube OD		PN bar	Dimensions						Version	Weight kg ca. per 100	Ordering Codes
	mm D1	mm D2		mm D3	mm D4	mm L1	mm L2	mm S1	mm S2			
L	8 L	6 L	500	3	3	34	36,7	17	14	A	4,72	FI-SNV-08/06L-V-W3-DKO
	10 L	6 L	500	3	3	35	37,3	19	14	A	5,50	FI-SNV-10/06L-V-W3-DKO
	10 L	8 L	500	5	5	35	37,3	19	17	A	5,21	FI-SNV-10/08L-V-W3-DKO
	12 L	6 L	400	3	3	35	37,3	22	14	B	18,04	FI-SNV-12/06L-V-W3-DKO
	12 L	8 L	400	5	5	36	38,3	22	17	B	6,22	FI-SNV-12/08L-V-W3-DKO
	12 L	10 L	400	6,5	6,5	36,5	38,3	22	19	A	6,96	FI-SNV-12/10L-V-W3-DKO
	12 L	12 S	400	8	8	39	41,3	24	22	B	9,42	FI-SNV-12L/12S-V-W3-DKO
	15 L	8 L	400	5	5	36,5	38,8	27	17	B	1,96	FI-SNV-15/08L-V-W3-DKO
	15 L	10 L	400	6,5	6,5	37,5	39,3	27	19	B	4,40	FI-SNV-15/10L-V-W3-DKO
	15 L	12 L	400	8	8	37	38,8	27	22	B	11,06	FI-SNV-15/12L-V-W3-DKO-GLB
	15 L	12 L	400	8	8	44	45,8	27	22	A	11,69	FI-SNV-15/12L-V-W3-DKO
	18 L	10 L	400	6,5	6,5	38	40,3	32	19	B	12,68	FI-SNV-18/10L-V-W3-DKO
	18 L	12 L	400	8	8	38	40,3	32	22	B	13,51	FI-SNV-18/12L-V-W3-DKO
	18 L	15 L	400	11	11	42,5	44,8	32	27	A	15,38	FI-SNV-18/15L-V-W3-DKO-GLB
	18 L	15 L	400	11	11	45	47,3	32	27	A	16,60	FI-SNV-18/15L-V-W3-DKO
	18 L	16 S	400	11	11	43,5	47,3	32	30	A	17,95	FI-SNV-18L/16S-V-W3-DKO

Standard seal material is FKM (Viton®).

Spare Parts / Accessories



O-Ring
Type **O-RING**

Page 239



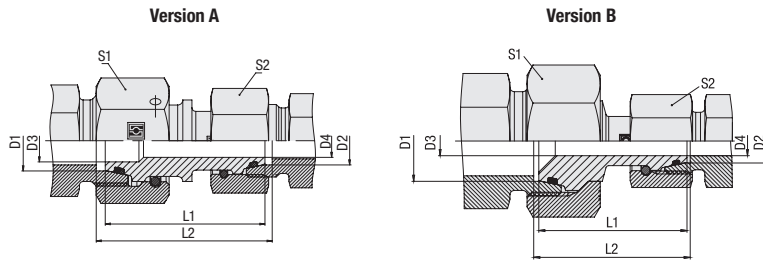

Straight Reducer with 24° Taper / O-Ring Type FI-SNV - Series L



Series	Tube OD mm		PN bar	Dimensions mm						Version	Weight kg ca. per 100	Ordering Codes
	D1	D2		D3	D4	L1	L2	S1	S2			
L	22 L	12 L	250	8	8	40,5	42,8	36	22	B	17,52	FI-SNV-22/12L-V-W3-DKO
	22 L	15 L	250	11	11	42	44,3	36	27	B	19,83	FI-SNV-22/15L-V-W3-DKO
	22 L	18 L	250	13	13	45	47,8	36	32	A	23,35	FI-SNV-22/18L-V-W3-DKO
	22 L	20 S	250	14	14	50	54,4	36	32	A	27,82	FI-SNV-22L/20S-V-W3-DKO
	28 L	15 L	250	11	11	43	45,3	41	27	B	23,86	FI-SNV-28/15L-V-W3-DKO
	28 L	18 L	250	13	13	45	47,8	41	32	B	26,44	FI-SNV-28/18L-V-W3-DKO
	28 L	22 L	250	17	17	46	48,8	41	36	B	28,93	FI-SNV-28/22L-V-W3-DKO
	28 L	25 S	250	18	18	52,5	58,4	41	46	A	41,48	FI-SNV-28L/25S-V-W3-DKO
	35 L	18 L	250	13	13	48	52,4	50	32	B	39,52	FI-SNV-35/18L-V-W3-DKO
	35 L	22 L	250	17	17	49,5	53,9	50	36	B	41,34	FI-SNV-35/22L-V-W3-DKO
	35 L	28 L	250	23	23	50	54,4	50	41	B	40,71	FI-SNV-35/28L-V-W3-DKO
	35 L	30 S	250	22	22	61	70	50	50	A	59,77	FI-SNV-35L/30S-V-W3-DKO
	42 L	22 L	250	17	17	49,5	54,4	60	36	B	56,50	FI-SNV-42/22L-V-W3-DKO
	42 L	28 L	250	23	23	50	54,9	60	41	B	56,10	FI-SNV-42/28L-V-W3-DKO
	42 L	35 L	250	28	28	53	59,5	60	50	B	60,70	FI-SNV-42/35L-V-W3-DKO
	42 L	38 S	250	30	30	55	67	60	60	A	78,2	FI-SNV-42L/38S-V-W3-DKO

Standard seal material is FKM (Viton®).

Ordering Codes

***FI-SNV*-10/*08*L*-V*-W3*-DKO**

* Straight Reducer with 24° Taper / O-Ring (DKO)	FI-SNV
* Outside Tube Diameter D1 (in mm)	-10
* Outside Tube Diameter D2 (in mm)	08
* Series	Light Series (pages 140/141) L Heavy Series (page 142) S
* Seal Material	FKM (Viton®) -V
* Material Code	Steel, zinc/nickel-plated -W3
Please contact STAUFF for alternative materials and surface finishings.	
* Assembling / Kitting	Fitting body supplied with swivel nuts and O-rings -DKO

Spare Parts / Accessories



O-Ring
Type **O-RING**

Page 239



Straight Reducer with 24° Taper / O-Ring Type FI-SNV ▪ Series S

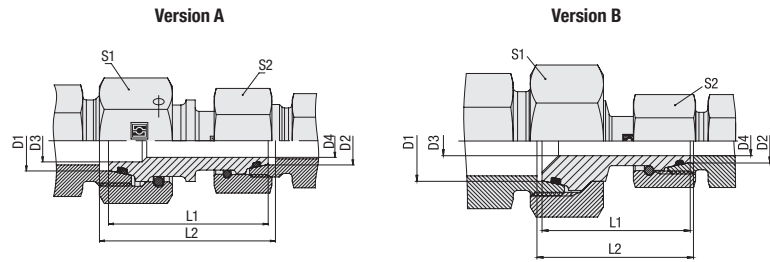

Ordering Codes

***FI-SNV*-10/*08*S*-V*-W3*-DKO**

- * Straight Reducer with 24° Taper / O-Ring (DKO) **FI-SNV**
- * Outside Tube Diameter D1 (in mm) **-10**
- * Outside Tube Diameter D2 (in mm) **08**
- * Series **L**
Light Series (pages 140/141)
S
Heavy Series (page 142)
- * Seal Material **-V**
FKM (Viton®)
- * Material Code **-W3**
Steel, zinc/nickel-plated
- Please contact STAUFF for alternative materials and surface finishings.
- * Assembling / Kitting **-DKO**
Fitting body supplied with swivel nuts and O-rings
- * Total length **-GLB**
dimension see table

Spare Parts / Accessories



O-Ring
Type **O-RING**

Page 239

Series	Tube OD mm		PN bar	Dimensions mm						Version	Weight kg ca. per 100	Ordering Codes
	D1	D2		D3	D4	L1	L2	S1	S2			
S	6S	6L	500	3	3	35,5	38,2	17	14	A	3,70	FI-SNV-06S/06L-V-W3-DKO
	8 S	6S	800	3	3	37	39,7	19	17	A	5,43	FI-SNV-08/06S-V-W3-DKO
	8 S	8 L	500	4	4	35,5	38,2	17	19	A	5,27	FI-SNV-08S/08L-V-W3-DKO
	10 S	6 S	800	3	3	40,5	43,2	22	17	A	6,30	FI-SNV-10/06S-V-W3-DKO
	10 S	8 S	800	4	4	39	41,7	22	19	A	7,60	FI-SNV-10/08S-V-W3-DKO
	10 S	10 L	500	6,5	6,5	38,5	40,8	22	19	A	6,98	FI-SNV-10S/10L-V-W3-DKO
	12 S	6 S	630	3	3	39	41,7	24	17	B	7,79	FI-SNV-12/06S-V-W3-DKO
	12 S	8 S	630	4	4	44	46,7	24	19	A	9,42	FI-SNV-12/08S-V-W3-DKO
	12 S	10 S	630	6,5	6,5	41,5	44,3	24	22	A	9,73	FI-SNV-12/10S-V-W3-DKO
	16 S	10 S	630	6,5	6,5	43,5	47,3	30	22	B	14,11	FI-SNV-16/10S-V-W3-DKO
	16 S	12 S	630	8	8	47,5	51,3	30	24	A	15,32	FI-SNV-16/12S-V-W3-DKO
	16 S	15 L	400	11	11	42,5	45,8	30	27	A	14,66	FI-SNV-16S/15L-V-W3-DKO
	20 S	12 S	400	8	8	48,5	52,9	36	24	B	21,90	FI-SNV-20/12S-V-W3-DKO
	20 S	16 S	400	11	11	52,5	57,9	36	30	A	24,68	FI-SNV-20/16S-V-W3-DKO
	20 S	18 L	400	13	13	47,5	51,9	36	32	A	23,43	FI-SNV-20S/18L-V-W3-DKO
	25 S	16 S	400	11	11	52	58,9	46	30	A	34,02	FI-SNV-25/16S-V-W3-DKO
	25 S	18 L	400	13	13	41,5	47,5	46	32	B	36,2	FI-SNV-25S/18L-V-W3-DKO-GLB
	25 S	18 L	400	13	13	50	56,3	46	32		38,4	FI-SNV-25S/18L-V-W3-DKO
	25 S	20 S	400	14	14	58	65,5	46	36	A	39,77	FI-SNV-25/20S-V-W3-DKO
	25 S	22 L	250	17	17	57	62,9	46	36	A	39,15	FI-SNV-25S/22L-V-W3-DKO
30 S	16 S	400	11	11	54	62,4	50	30	B	47,00	FI-SNV-30/16S-V-W3-DKO	
30 S	20 S	400	14	14	58,5	67,5	50	36	B	51,00	FI-SNV-30/20S-V-W3-DKO	
30 S	25 S	400	17	17	60	70,5	50	46	A	56,80	FI-SNV-30/25S-V-W3-DKO	
30 S	28 L	250	22	22	59	66,4	50	41	A	45,5	FI-SNV-30S/28L-V-W3-DKO	
38 S	20 S	400	14	14	61	72,5	60	36	B	71,30	FI-SNV-38/20S-V-W3-DKO	
38 S	25 S	400	17	17	62,5	75,5	60	46	B	80,70	FI-SNV-38/25S-V-W3-DKO	
38 S	30 S	400	22	22	64,5	79	60	50	A	76,90	FI-SNV-38/30S-V-W3-DKO	
38 S	35 L	250	28	28	62	73,5	60	50	A	69,86	FI-SNV-38S/35L-V-W3-DKO	

Standard seal material is FKM (Viton®).



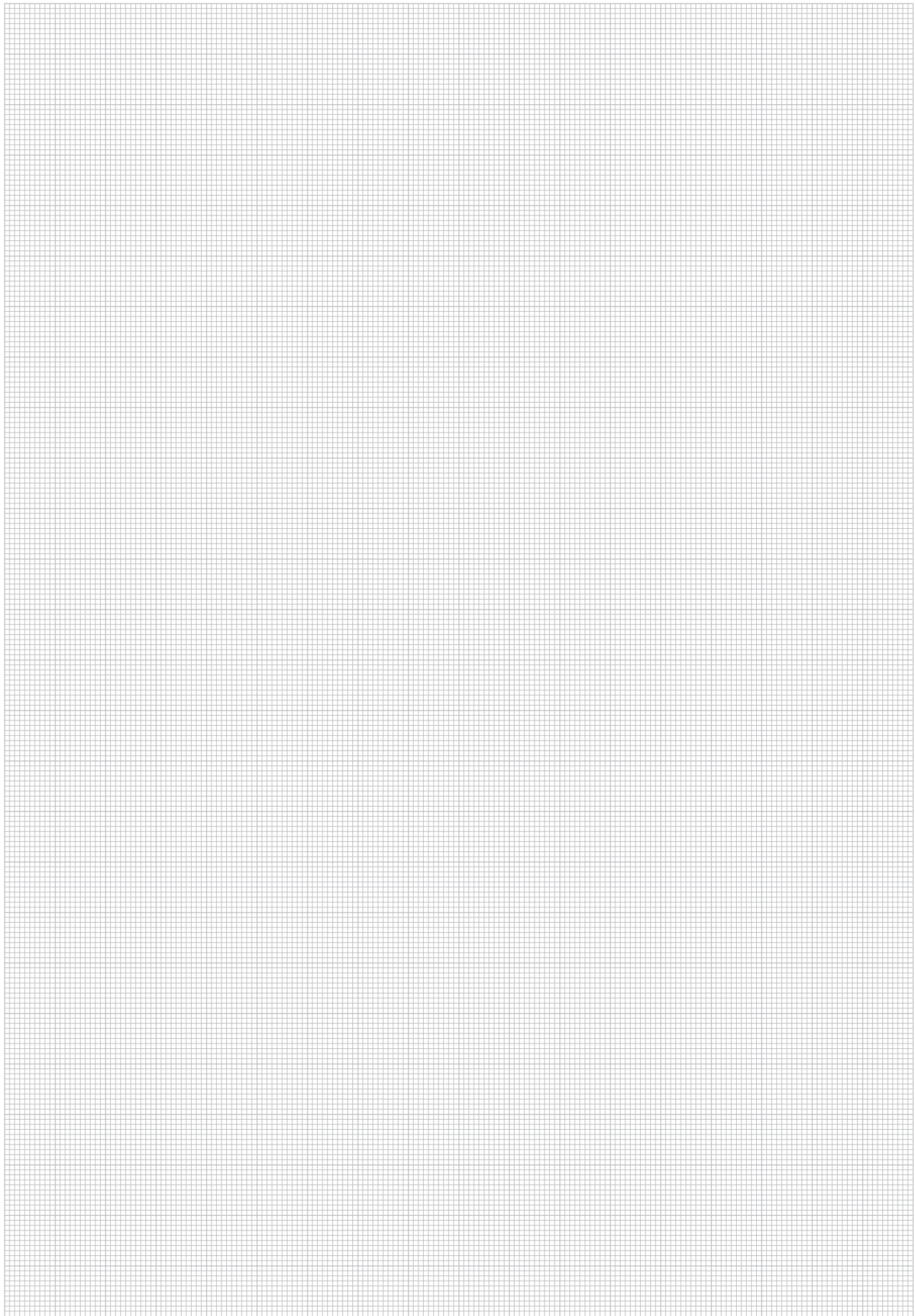

H



Straight Reducer for Tube Ends with 24° Taper / O-Ring Type FI-RESDS • Series L

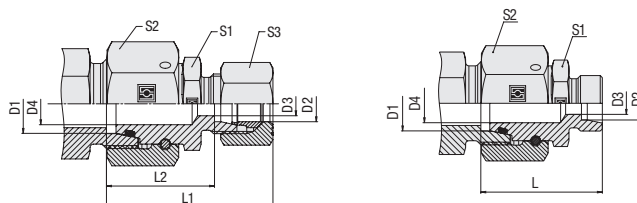

Ordering Codes

***FI-RESDS*-10/*08*L*-V*-W3*-DKO*-MS**

* Straight Reducer for Tube Ends with 24° Taper / O-Ring (DKO) **FI-RESDS**

* Outside Tube Diameter D1 (in mm) **-10**

* Outside Tube Diameter D2 (in mm) **08**

* Series Light Series (pages 144/145) **L**
Heavy Series (pages 146/147) **S**

* Seal Material FKM (Viton®) **-V**

* Material Code Steel, zinc/nickel-plated **-W3**

Please contact STAUFF for alternative materials and surface finishings.

* Assembling / Kitting Fitting body supplied with swivel nut and O-ring **-DKO**

Fitting body supplied with cutting ring and union nut **-MS**

Fitting body supplied with soft-sealing cutting ring and union nut **-MSV**

Series	Tube OD mm		PN bar	Dimensions mm									Weight kg ca. per 100	Ordering Codes ³
	D1	D2		D3	D4	L	L ¹	L2	S1	S2	S3			
L	8	6	500	4	4	30,5	38,5	23,5	12	17	14	3,01	FI-RESDS-08/06L-V-W3-DKO	
	10	6	500	4	4	32	40	25	14	19	14	3,80	FI-RESDS-10/06L-V-W3-DKO	
	10	8	500	6	6	32	40	25	14	19	17	3,99	FI-RESDS-10/08L-V-W3-DKO	
	10	12	400	10	6,5	34	45	27	19	19	22	5,01	FI-RESDS-10/12L-V-W3-DKO	
	12	6	400	4	4	32	40	25	17	22	14	5,69	FI-RESDS-12/06L-V-W3-DKO	
	12	8	400	6	6	32	40	25	17	22	17	5,53	FI-RESDS-12/08L-V-W3-DKO	
	12	10	400	8	8	33	41	26	17	22	19	5,33	FI-RESDS-12/10L-V-W3-DKO	
	12	15	400	12	8	34,5	44	27,5	24	22	27	7,16	FI-RESDS-12/15L-V-W3-DKO	
	15	6	400	4	11	35,5	43,5	28,5	22	27	14	8,83	FI-RESDS-15/06L-V-W3-DKO	
	15	8	400	6	11	35,5	44	28,5	22	27	17	9,08	FI-RESDS-15/08L-V-W3-DKO	
	15	10	400	8	8	36,5	44,5	29,5	22	27	19	9,61	FI-RESDS-15/10L-V-W3-DKO	
	15	12	400	10	10	36,5	44,5	29,5	22	27	22	9,25	FI-RESDS-15/12L-V-W3-DKO	
	18	6	400	4	13	35	43	28	24	32	14	11,07	FI-RESDS-18/06L-V-W3-DKO	
	18	8	400	6	13	35	43	28	24	32	17	7,57	FI-RESDS-18/08L-V-W3-DKO	
	18	10	400	8	8	36	44	29	24	32	19	12,64	FI-RESDS-18/10L-V-W3-DKO	
	18	12	400	10	10	36	44	29	24	32	22	12,24	FI-RESDS-18/12L-V-W3-DKO	
	18	15	400	12	12	37	45	30	24	32	27	12,27	FI-RESDS-18/15L-V-W3-DKO	
	22	6	250	4	17	39	47	32	27	36	14	16,34	FI-RESDS-22/06L-V-W3-DKO	
	22	8	250	6	17	39	48	32	27	36	17	16,27	FI-RESDS-22/08L-V-W3-DKO	
	22	10	250	8	17	40	49	33	27	36	19	16,33	FI-RESDS-22/10L-V-W3-DKO	
	22	12	250	10	17	40	49	33	27	36	22	16,30	FI-RESDS-22/12L-V-W3-DKO	
	22	15	250	12	12	41	50	34	27	36	27	19,01	FI-RESDS-22/15L-V-W3-DKO	
22	18	250	15	15	41	50	33,5	27	36	32	18,13	FI-RESDS-22/18L-V-W3-DKO		
L / S	22	20	250	16	16	47,5	60	37	36	32	36	22,22	FI-RESDS-22L/20S-V-W3-DKO	
	28	6	250	4	23	41	49	34	36	41	14	22,90	FI-RESDS-28/06L-V-W3-DKO	
	28	8	250	6	23	41	50	34	36	41	17	20,95	FI-RESDS-28/08L-V-W3-DKO	
	28	10	250	8	23	42	51	35	36	41	19	21,74	FI-RESDS-28/10L-V-W3-DKO	
	28	12	250	10	23	42	51	35	36	41	22	10,22	FI-RESDS-28/12L-V-W3-DKO	
	28	15	250	12	23	43	52	36	36	41	27	18,85	FI-RESDS-28/15L-V-W3-DKO	
	28	18	250	15	23	43	52	35,5	36	41	32	22,50	FI-RESDS-28/18L-V-W3-DKO	
	28	22	250	19	23	45	54	37,5	36	41	36	22,80	FI-RESDS-28/22L-V-W3-DKO	

¹ Approx.imate dimension in assembled condition.
² Weight excluding cutting ring and union nut.
³ Standard scope of delivery: Fitting body only.

Standard seal material is FKM (Viton®).

Connecting Parts

-  Cutting Ring Type **FI-DS** Page 28
-  Soft-Sealing Cutting Ring Type **FI-WDDS** Page 29
-  Support Sleeve Type **FI-VH** Page 31
-  STAUFF Form EVO Sealing Ring Type **FI-FD** Page 32
-  Union Nut Type **FI-M** Page 33
-  37° Flared Tube Fitting Set Type **FI-AB** Page 37

Spare Parts / Accessories

-  O-Ring Type **O-RING** Page 239

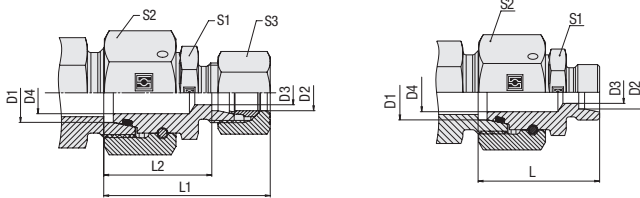

Straight Reducer for Tube Ends with 24° Taper / O-Ring Type FI-RESDS - Series L

Series	Tube OD mm		PN bar	Dimensions mm									Weight kg ca. per 100	Ordering Codes ³
	D1	D2		D3	D4	L	L1 ¹	L2	S1	S2	S3			
L	35	6	250	4	28	44	52,5	37	46	50	14	7,82	FI-RESDS-35/06L-V-W3-DKO	
	35	8	250	6	28	44	52,5	37	46	50	17	35,43	FI-RESDS-35/08L-V-W3-DKO	
	35	10	250	8	28	45	53,5	38	46	50	19	35,35	FI-RESDS-35/10L-V-W3-DKO	
	35	12	250	10	28	45	56	38	46	50	22	33,34	FI-RESDS-35/12L-V-W3-DKO	
	35	15	250	12	28	46	55,5	39	46	50	27	15,22	FI-RESDS-35/15L-V-W3-DKO	
	35	18	250	15	28	46	57	38,5	46	50	32	34,32	FI-RESDS-35/18L-V-W3-DKO	
	35	22	250	19	28	48	59	40,5	46	50	36	34,80	FI-RESDS-35/22L-V-W3-DKO	
	35	28	250	24	24	48	59	40,5	46	50	41	38,10	FI-RESDS-35/28L-V-W3-DKO	
	42	6	250	4	35	47,5	56	40,5	50	60	14	52,66	FI-RESDS-42/06L-V-W3-DKO	
	42	8	250	6	35	47,5	59,5	40,5	50	60	17	52,58	FI-RESDS-42/08L-V-W3-DKO	
	42	10	250	8	35	48,5	60,5	41,5	50	60	19	52,58	FI-RESDS-42/10L-V-W3-DKO	
	42	12	250	10	35	48,5	60,5	41,5	50	60	22	52,60	FI-RESDS-42/12L-V-W3-DKO	
	42	15	250	12	35	49,5	61,5	42,5	50	60	27	52,30	FI-RESDS-42/15L-V-W3-DKO	
	42	18	250	15	35	49,5	61,5	42	50	60	32	52,00	FI-RESDS-42/18L-V-W3-DKO	
	42	22	250	19	35	51,5	63,5	44	50	60	36	50,10	FI-RESDS-42/22L-V-W3-DKO	
	42	28	250	24	35	51,5	63,5	44	50	60	41	50,19	FI-RESDS-42/28L-V-W3-DKO	
42	35	250	30	30	53,5	65,5	43	50	60	50	55,90	FI-RESDS-42/35L-V-W3-DKO		

¹ Approx.imate dimension in assembled condition.

² Weight excluding cutting ring and union nut.

³ Standard scope of delivery: Fitting body only.

Standard seal material is FKM (Viton®).

Ordering Codes
***FI-RESDS*-10/*08*L*-V*-W3*-DKO*-MS**

 * Straight Reducer for Tube Ends with 24° Taper / O-Ring (DKO) **FI-RESDS**

 * Outside Tube Diameter D1 (in mm) **-10**

 * Outside Tube Diameter D2 (in mm) **08**

 * Series Light Series (pages 144/145) **L**
 Heavy Series (pages 146/147) **S**

 * Seal Material FKM (Viton®) **-V**

 * Material Code Steel, zinc/nickel-plated **-W3**

Please contact STAUFF for alternative materials and surface finishings.

 * Assembling / Kitting Fitting body supplied with swivel nut and O-ring **-DKO**

 Fitting body supplied with cutting ring and union nut **-MS**

 Fitting body supplied with soft-sealing cutting ring and union nut **-MSV**
Connecting Parts

	Cutting Ring Type FI-DS	Page 28
	Soft-Sealing Cutting Ring Type FI-WDDS	Page 29
	Support Sleeve Type FI-VH	Page 31
	STAUFF Form EVO Sealing Ring Type FI-FD	Page 32
	Union Nut Type FI-M	Page 33
	37° Flared Tube Fitting Set Type FI-AB	Page 37

Spare Parts / Accessories

	O-Ring Type O-RING	Page 239
--	------------------------------	----------



Straight Reducer for Tube Ends with 24° Taper / O-Ring Type FI-RESDS • Series S

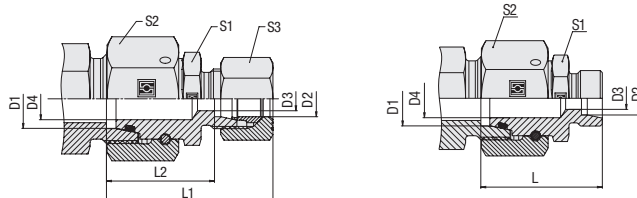

Ordering Codes

***FI-RESDS*-10/*08*S*-V*-W3*-DKO*-MS**

* Straight Reducer for Tube Ends with 24° Taper / O-Ring (DKO) **FI-RESDS**

* Outside Tube Diameter D1 (in mm) **-10**

* Outside Tube Diameter D2 (in mm) **08**

* Series Light Series (pages 144/145) **L**
Heavy Series (pages 146/147) **S**

* Seal Material FKM (Viton®) **-V**

* Material Code Steel, zinc/nickel-plated **-W3**

Please contact STAUFF for alternative materials and surface finishings.

* Assembling / Kitting Fitting body supplied with swivel nut and O-ring **-DKO**

Fitting body supplied with cutting ring and union nut **-MS**

Fitting body supplied with soft-sealing cutting ring and union nut **-MSV**

Series	Tube OD mm		PN bar	Dimensions mm									Weight kg ca. per 100	Ordering Codes ³
	D1	D2		D3	D4	L	L ¹	L2	S1	S2	S3			
S	8	6	800	4	4	34	42	27	14	19	17	4,46	FI-RESDS-08/06S-V-W3-DKO	
	10	6	800	4	4	34,5	42,5	27,5	17	22	17	5,93	FI-RESDS-10/06S-V-W3-DKO	
	10	8	800	5	5	34,5	42,5	27,5	17	22	19	6,07	FI-RESDS-10/08S-V-W3-DKO	
	12	6	630	4	4	37	48	30	19	24	17	7,96	FI-RESDS-12/06S-V-W3-DKO	
	12	8	630	5	5	37	48	30	19	24	19	8,04	FI-RESDS-12/08S-V-W3-DKO	
	12	10	630	7	7	37	48	29,5	19	24	22	7,90	FI-RESDS-12/10S-V-W3-DKO	
	14	6	630	4	4	38,5	47	31,5	22	27	17	10,46	FI-RESDS-14/06S-V-W3-DKO	
	14	8	630	5	5	38,5	47	31,5	22	27	19	10,53	FI-RESDS-14/08S-V-W3-DKO	
	14	10	630	7	7	37,5	47	30	22	27	22	10,12	FI-RESDS-14/10S-V-W3-DKO	
	14	12	630	8	8	38,5	49	31	22	27	24	10,44	FI-RESDS-14/12S-V-W3-DKO	
	16	6	630	4	11	39	49	32	22	30	17	10,79	FI-RESDS-16/06S-V-W3-DKO	
	16	8	630	5	11	39	49	31,5	22	30	19	11,04	FI-RESDS-16/08S-V-W3-DKO	
	16	10	630	7	7	39	49	31,5	22	30	22	7,67	FI-RESDS-16/10S-V-W3-DKO	
	16	12	630	8	8	39	49	31,5	22	30	24	12,07	FI-RESDS-16/12S-V-W3-DKO	
	16	14	630	10	10	41	52	33	24	30	27	12,64	FI-RESDS-16/14S-V-W3-DKO	
	S / L	16	15	400	11	11	39	48	31,5	24	30	27	11,66	FI-RESDS-16S/15L-V-W3-DKO
20		6	420	4	14	43	54	36	27	36	17	17,16	FI-RESDS-20/06S-V-W3-DKO	
20		8	420	5	14	43	54	36	27	36	19	17,61	FI-RESDS-20/08S-V-W3-DKO	
20		10	420	7	14	43	54	35,5	27	36	22	17,49	FI-RESDS-20/10S-V-W3-DKO	
S / L	20	12	420	8	14	43	54	35,5	27	36	24	17,76	FI-RESDS-20/12S-V-W3-DKO	
	20	14	420	10	14	45	56,5	37	27	36	27	19,83	FI-RESDS-20/14S-V-W3-DKO	
	20	15	400	12	12	43	52,5	35,5	27	36	30	18,38	FI-RESDS-20S/15L-V-W3-DKO	
	20	16	420	12	12	45	56	36,5	27	36	30	19,34	FI-RESDS-20/16S-V-W3-DKO	
S / L	20	18	400	14	14	43	53	35,5	27	36	32	18,10	FI-RESDS-20S/18L-V-W3-DKO	

¹ Approximate dimension in assembled condition.

² Weight excluding cutting ring and union nut.

³ Standard scope of delivery: Fitting body only.

Standard seal material is FKM (Viton®).

Connecting Parts

	Cutting Ring Type FI-DS	Page 28
	Soft-Sealing Cutting Ring Type FI-WDDS	Page 29
	Support Sleeve Type FI-VH	Page 31
	STAUFF Form EVO Sealing Ring Type FI-FD	Page 32
	Union Nut Type FI-M	Page 33
	37° Flared Tube Fitting Set Type FI-AB	Page 37

Spare Parts / Accessories

	O-Ring Type O-RING	Page 239
--	------------------------------	----------

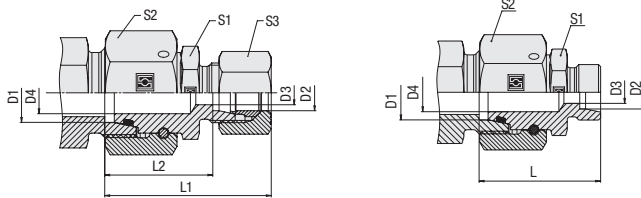

**Straight Reducer for Tube Ends with 24° Taper / O-Ring
Type FI-RESDS • Series S**

Series	Tube OD mm		PN bar	Dimensions mm							Weight kg ca. per 100	Ordering Codes ³	
	D1	D2		D3	D4	L	L1 ¹	L2	S1	S2			S3
S	25	6	420	4	18	45,5	57,5	38,5	36	46	17	29,87	FI-RESDS-25/06S-V-W3-DKO
	25	8	420	5	18	45,5	57,5	38,5	36	46	19	30,39	FI-RESDS-25/08S-V-W3-DKO
	25	10	420	7	18	45,5	57,5	38,5	36	46	22	16,95	FI-RESDS-25/10S-V-W3-DKO
	25	12	420	8	18	45,5	57,5	38,5	36	46	24	30,41	FI-RESDS-25/12S-V-W3-DKO
	25	14	420	10	18	47,5	59	39,5	36	46	27	30,95	FI-RESDS-25/14S-V-W3-DKO
S / L	25	16	420	12	18	47,5	59,5	39	36	46	30	30,29	FI-RESDS-25/16S-V-W3-DKO
	25	18	400	15	18	45,5	55,5	38	36	46	32	30,54	FI-RESDS-25S/18L-V-W3-DKO
	25	20	420	16	16	49,5	61,5	39	36	46	36	32,97	FI-RESDS-25/20S-V-W3-DKO
	30	6	420	4	22	51	64	44	41	50	17	37,93	FI-RESDS-30/06S-V-W3-DKO
	30	8	420	5	22	51	64	44	41	50	19	31,17	FI-RESDS-30/08S-V-W3-DKO
	30	10	420	7	22	51	64	43,5	41	50	22	38,28	FI-RESDS-30/10S-V-W3-DKO
	30	12	420	8	22	51	64	43,5	41	50	24	38,65	FI-RESDS-30/12S-V-W3-DKO
	30	14	420	10	22	53	64,5	45	41	50	27	38,88	FI-RESDS-30/14S-V-W3-DKO
	30	16	420	12	22	53	66	44,5	41	50	30	38,59	FI-RESDS-30/16S-V-W3-DKO
	30	20	420	16	22	55	58	44,5	41	50	36	39,86	FI-RESDS-30/20S-V-W3-DKO
	30	25	420	20	20	57	70	45	41	50	46	42,96	FI-RESDS-30/25S-V-W3-DKO
	38	6	420	4	30	54,5	69,5	47,5	50	60	17	55,50	FI-RESDS-38/06S-V-W3-DKO
	38	8	420	5	30	54,5	69,5	47,5	50	60	19	55,50	FI-RESDS-38/08S-V-W3-DKO
	38	10	420	7	30	54,5	69,5	47	50	60	22	56,40	FI-RESDS-38/10S-V-W3-DKO
	38	12	420	8	30	54,5	69,5	47	50	60	24	55,50	FI-RESDS-38/12S-V-W3-DKO
	38	14	420	10	30	56,5	68	48,5	50	60	27	62,87	FI-RESDS-38/14S-V-W3-DKO
	38	16	420	12	30	56,5	71,5	48	50	60	30	55,80	FI-RESDS-38/16S-V-W3-DKO
	38	20	420	16	30	58,5	73,5	48	50	60	36	57,40	FI-RESDS-38/20S-V-W3-DKO
	38	25	420	20	30	60,5	75,5	48,5	50	60	46	59,30	FI-RESDS-38/25S-V-W3-DKO
	38	30	420	25	25	62,5	77,5	49	50	60	50	63,70	FI-RESDS-38/30S-V-W3-DKO

¹ Approx.imate dimension in assembled condition.

² Weight excluding cutting ring and union nut.

³ Standard scope of delivery: Fitting body only.

Standard seal material is FKM (Viton®).

Ordering Codes
***FI-RESDS*-10/*08*S*-V*-W3*-DKO*-MS**

 * Straight Reducer for Tube Ends with 24° Taper / O-Ring (DKO) **FI-RESDS**

 * Outside Tube Diameter D1 (in mm) **-10**

 * Outside Tube Diameter D2 (in mm) **08**

 * Series Light Series (pages 144/145) **L**
 Heavy Series (pages 146/147) **S**

 * Seal Material FKM (Viton®) **-V**

 * Material Code Steel, zinc/nickel-plated **-W3**

Please contact STAUFF for alternative materials and surface finishings.

 * Assembling / Kitting Fitting body supplied with swivel nut and O-ring **-DKO**

 Fitting body supplied with cutting ring and union nut **-MS**

 Fitting body supplied with soft-sealing cutting ring and union nut **-MSV**
Connecting Parts

	Cutting Ring Type FI-DS	Page 28
	Soft-Sealing Cutting Ring Type FI-WDDS	Page 29
	Support Sleeve Type FI-VH	Page 31
	STAUFF Form EVO Sealing Ring Type FI-FD	Page 32
	Union Nut Type FI-M	Page 33
	37° Flared Tube Fitting Set Type FI-AB	Page 37

Spare Parts / Accessories

	O-Ring Type O-RING	Page 239
--	------------------------------	----------



**Distance Adaptors with 24° Taper / O-Ring
Type FI-RESDS • Series L / S**

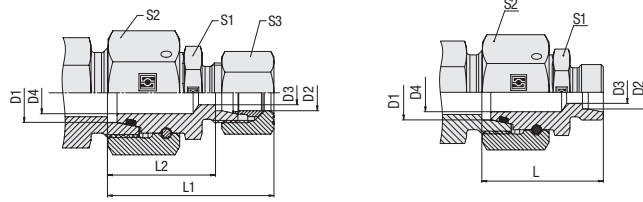

Ordering Codes

***FI-RESDS*-08*L*-V*-W3*-DKO*-MS**

* Distance Adaptors with 24° Taper / O-Ring (DKO) **FI-RESDS**

* Outside Tube Diameter D1/D2 (in mm) **-08**

* Series Light Series **L**
Heavy Series **S**

* Seal Material FKM (Viton®) **-V**

* Material Code Steel, zinc/nickel-plated **-W3**

Please contact STAUFF for alternative materials and surface finishings.

* Assembling / Kitting Fitting body supplied with swivel nut and O-ring **-DKO**

Fitting body supplied with cutting ring and union nut **-MS**

Fitting body supplied with soft-sealing cutting ring and union nut **-MSV**

Series	Tube OD mm		PN bar	Dimensions mm								Weight kg ca. per 100	Ordering Codes ³
	D1	D2		D3	D4	L	L ¹	L2	S1	S2	S3		
L	6	6	500	3	3	43	51	36	12	14	14	4,33	FI-RESDS-06L-V-W3-DKO
	8	8	500	5	5	43	51	36	14	17	17	4,63	FI-RESDS-08L-V-W3-DKO
	10	10	500	6,5	6,5	43	51	36	17	19	19	6,15	FI-RESDS-10L-V-W3-DKO
	12	12	400	8	8	43	52	36	19	22	22	7,85	FI-RESDS-12L-V-W3-DKO
	15	15	400	11	11	43	52	36	24	27	27	12,05	FI-RESDS-15L-V-W3-DKO
	18	18	400	13	13	43,5	53	36	27	32	32	15,61	FI-RESDS-18L-V-W3-DKO
	22	22	250	17	17	47,5	58,5	40	32	36	36	21,63	FI-RESDS-22L-V-W3-DKO
	28	28	250	23	23	47,5	58,5	40	41	41	41	27,45	FI-RESDS-28L-V-W3-DKO
	35	35	250	24	24	60,5	73,5	50	46	50	50	53,4	FI-RESDS-35L-V-W3-DKO
	42	42	250	35	35	71	84,5	60	55	60	60	77,7	FI-RESDS-42L-V-W3-DKO
S	6	6	800	3	3	43	51	36	14	17	17	4,91	FI-RESDS-06S-V-W3-DKO
	8	8	800	4	4	43	51	36	17	19	19	6,64	FI-RESDS-08S-V-W3-DKO
	10	10	800	6,5	6,5	43,5	53	36	19	22	22	8,18	FI-RESDS-10S-V-W3-DKO
	12	12	630	8	8	43,5	54	36	22	24	24	10,28	FI-RESDS-12S-V-W3-DKO
	14	14	630	9	9	48	59	40	24	27	27	13,75	FI-RESDS-14S-V-W3-DKO
	16	16	630	11	11	48,5	60	40	27	30	30	16,53	FI-RESDS-16S-V-W3-DKO
	20	20	420	14	14	56,5	69	46	32	36	36	26,97	FI-RESDS-20S-V-W3-DKO
	25	25	420	18	18	62	75	50	41	46	46	46,37	FI-RESDS-25S-V-W3-DKO
	30	30	420	22	22	69,5	84,5	56	46	50	50	60	FI-RESDS-30S-V-W3-DKO
	38	38	420	32	32	76	93	60	55	60	60	82,5	FI-RESDS-38S-V-W3-DKO

¹ Approximate dimension in assembled condition.

² Weight excluding cutting ring and union nut.

³ Standard scope of delivery: Fitting body only.

Standard seal material is FKM (Viton®).

Connecting Parts

	Cutting Ring Type FI-DS	Page 28
	Soft-Sealing Cutting Ring Type FI-WDDS	Page 29
	Support Sleeve Type FI-VH	Page 31
	STAUFF Form EVO Sealing Ring Type FI-FD	Page 32
	Union Nut Type FI-M	Page 33
	37° Flared Tube Fitting Set Type FI-AB	Page 37

Spare Parts / Accessories

	O-Ring Type O-RING	Page 239
--	------------------------------	----------



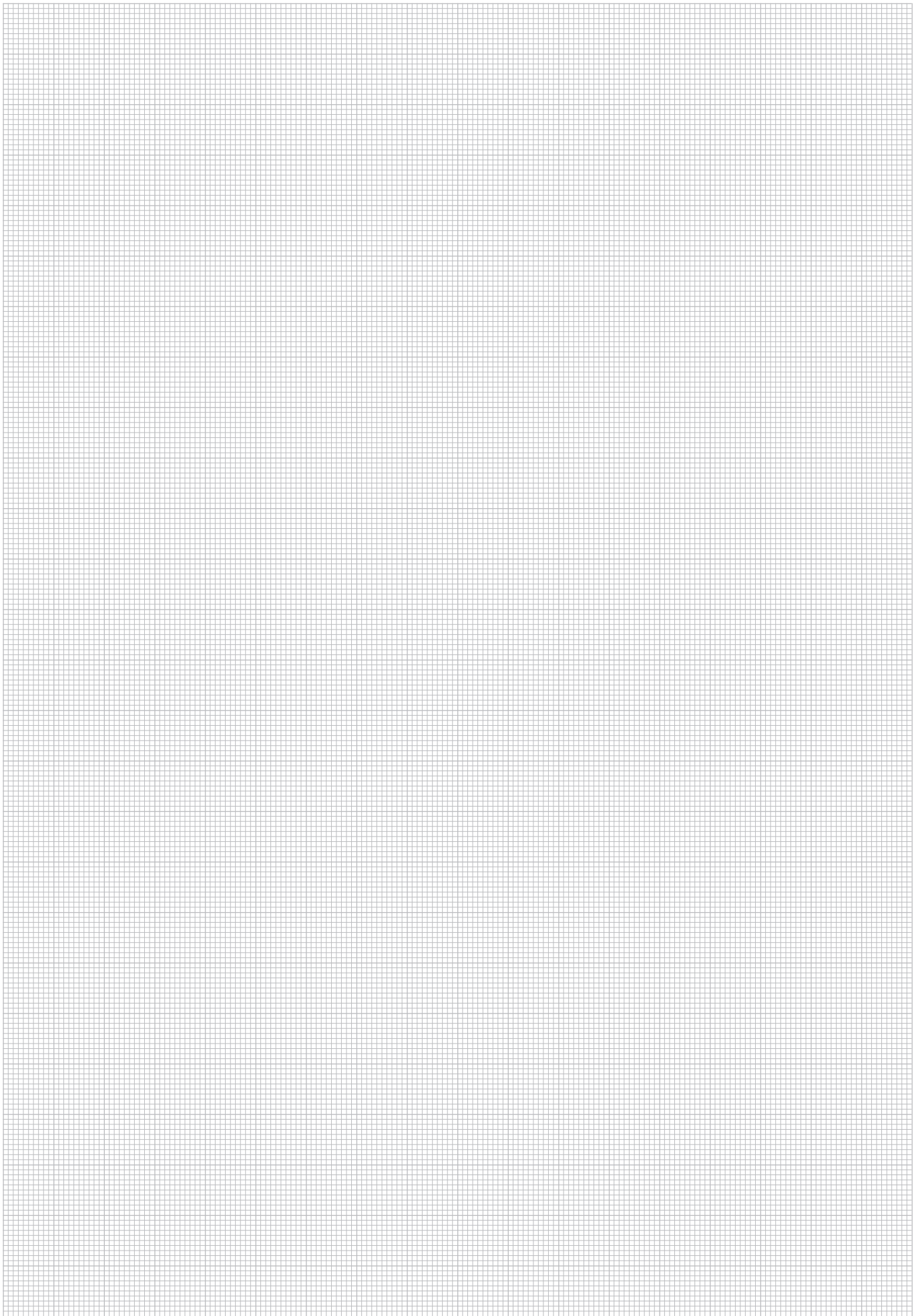

H



Adjustable Elbow (90°) with 24° Taper / O-Ring
Type FI-EWD ▪ Series L / S

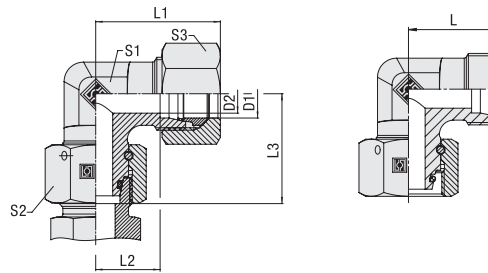

Ordering Codes

***FI-EWD*-10*L*-V*-W3*-DKO*-MS**

- * Adjustable Elbow (90°) with 24° Taper / O-Ring (DKO) **FI-EWD**
 - * Outside Tube Diameter D1 (in mm) **-10**
 - * Series **L**
S
 - * Seal Material **-V**
-MS
-MSV
 - * Material Code **-W3**
 - * Assembling / Kitting **-DKO**
-MS
-MSV
- Please contact STAUFF for alternative materials and surface finishings.
- Fitting body supplied with swivel nut and O-ring
- Fitting body supplied with cutting ring and union nut
- Fitting body supplied with soft-sealing cutting ring and union nut

Series	Tube OD mm D1	PN bar	Dimensions mm									Weight kg ca. per 100	Ordering Codes ³
			D2	L	L1 ¹	L2	L3	S1	S2	S3			
L	6	500	4	19	27	12	26	12	14	14	4,00	FI-EWD-06L-V-W3-DKO	
	8	500	6	21	29	14	27,5	12	17	17	4,03	FI-EWD-08L-V-W3-DKO	
	10	500	8	22	30	15	29	14	19	19	5,36	FI-EWD-10L-V-W3-DKO	
	12	400	10	24	32	17	29,5	17	22	22	7,60	FI-EWD-12L-V-W3-DKO	
	15	400	12	28	36	21	32,5	19	27	27	12,50	FI-EWD-15L-V-W3-DKO	
	18	400	15	31	40	23,5	35,5	24	32	32	18,23	FI-EWD-18L-V-W3-DKO	
	22	400	19	35	44	27,5	38,5	27	36	36	24,57	FI-EWD-22L-V-W3-DKO	
	28	250	24	38	47	30,5	41,5	36	41	41	34,95	FI-EWD-28L-V-W3-DKO	
	35	250	30	45	56	34,5	51	41	50	50	56,50	FI-EWD-35L-V-W3-DKO	
	42	250	36	51	63	40	56	50	60	60	85,10	FI-EWD-42L-V-W3-DKO	
S	6	800	4	23	31	16	27	12	17	17	4,67	FI-EWD-06S-V-W3-DKO	
	8	800	5	24	32	17	27,5	14	19	19	6,29	FI-EWD-08S-V-W3-DKO	
	10	800	7	25	34	17,5	30	17	22	22	8,58	FI-EWD-10S-V-W3-DKO	
	12	630	8	29	38	21,5	31	17	24	24	11,02	FI-EWD-12S-V-W3-DKO	
	14	630	10	30	40	22	35	19	27	27	14,34	FI-EWD-14S-V-W3-DKO	
	16	630	12	33	43	24,5	36,5	24	30	30	19,26	FI-EWD-16S-V-W3-DKO	
	20	420	16	37	48	26,5	44,5	27	36	36	29,86	FI-EWD-20S-V-W3-DKO	
	25	420	20	42	54	30	50	36	46	46	53,20	FI-EWD-25S-V-W3-DKO	
	30	420	25	49	62	35,5	55	41	50	50	72,50	FI-EWD-30S-V-W3-DKO	
	38	420	32	57	72	41	63	50	60	60	109,40	FI-EWD-38S-V-W3-DKO	

¹ Approximate dimension in assembled condition.
² Weight excluding cutting ring and union nut.
³ Standard scope of delivery: Fitting body only.



Typical application with a Straight Male Stud Fitting FI-GE-...

Standard seal material is FKM (Viton®).

Connecting Parts

- Cutting Ring
Type **FI-DS** Page 28
- Soft-Sealing Cutting Ring
Type **FI-WDDS** Page 29
- Support Sleeve
Type **FI-VH** Page 31
- STAUFF Form EVO Sealing Ring
Type **FI-FD** Page 32
- Union Nut
Type **FI-M** Page 33
- 37° Flared Tube Fitting Set
Type **FI-AB** Page 37

Spare Parts / Accessories

- O-Ring
Type **O-RING** Page 239

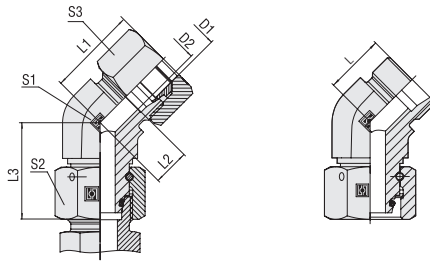

**Adjustable Elbow (45°) with 24° Taper / O-Ring
Type FI-EVD • Series L / S**

Series	Tube OD mm	PN bar	Dimensions mm									Weight kg ca. per 100	Ordering Codes ³
			D1	D2	L	L1 ¹	L2	L3	S1	S2	S3		
L	6	500	4	16	24	9	26	14	14	14	4,63	FI-EVD-06L-V-W3-DK0	
	8	500	6	19	27	12	27,5	14	17	17	4,72	FI-EVD-08L-V-W3-DK0	
	10	500	8	19	27	12	29	19	19	19	7,56	FI-EVD-10L-V-W3-DK0	
	12	400	10	21	29	14	29,5	19	22	22	8,66	FI-EVD-12L-V-W3-DK0	
	15	400	12	24	32	17	32,5	22	27	27	12,96	FI-EVD-15L-V-W3-DK0	
	18	400	15	24	33	17	35,5	27	32	32	20,64	FI-EVD-18L-V-W3-DK0	
	22	400	19	26	35	19	38,5	30	36	36	26,41	FI-EVD-22L-V-W3-DK0	
	28	250	24	30,5	40	23	41,5	36	41	41	34,69	FI-EVD-28L-V-W3-DK0	
	35	250	30	37	48	27	51	50	50	50	79,60	FI-EVD-35L-V-W3-DK0	
42	250	36	37	49	26	56	50	60	60	83,20	FI-EVD-42L-V-W3-DK0		
S	6	630	4	16	24	9	27	14	17	17	4,90	FI-EVD-06S-V-W3-DK0	
	8	630	5	19	27	12	27,5	19	19	19	5,17	FI-EVD-08S-V-W3-DK0	
	10	630	7	21	30	13	30	19	22	22	9,44	FI-EVD-10S-V-W3-DK0	
	12	630	8	24	33	17	31	19	24	24	12,90	FI-EVD-12S-V-W3-DK0	
	14	400	10	24	34	16	33,5	22	27	27	14,4	FI-EVD-14S-V-W3-DK0	
	16	400	12	24	34	16	36,5	19	30	30	16,76	FI-EVD-16S-V-W3-DK0	
	20	400	16	26,5	37,5	16	44,5	27	36	36	30,72	FI-EVD-20S-V-W3-DK0	
	25	400	20	30,5	42,5	19	50	36	46	46	50,10	FI-EVD-25S-V-W3-DK0	
	30	400	25	37	50	24	55	50	50	50	92,90	FI-EVD-30S-V-W3-DK0	
	38	315	32	37	52	21	63	50	60	60	98,50	FI-EVD-38S-V-W3-DK0	

¹ Approx.imate dimension in assembled condition.

² Weight excluding cutting ring and union nut.

³ Standard scope of delivery: Fitting body only.

Standard seal material is FKM (Viton®).

 Typical application with a
Straight Male Stud Fitting FI-GE-...

Ordering Codes
***FI-EVD*-10*L*-V*-W3*-DK0*-MS**

- * Adjustable Elbow (45°)
with 24° Taper / O-Ring (DKO) FI-EVD
- * Outside Tube Diameter D1 (in mm) -10
- * Series L
S
- * Seal Material FKM (Viton®) -V
- * Material Code Steel, zinc/nickel-plated -W3
- Please contact STAUFF for alternative materials and surface finishings.
- * Assembling / Kitting -DK0
- Fitting body supplied with swivel nut and O-ring
- Fitting body supplied with cutting ring and union nut -MS
- Fitting body supplied with soft-sealing cutting ring and union nut -MSV

Connecting Parts

- Cutting Ring
Type **FI-DS** Page 28
- Soft-Sealing Cutting Ring
Type **FI-WDDS** Page 29
- Support Sleeve
Type **FI-VH** Page 31
- STAUFF Form EVO Sealing Ring
Type **FI-FD** Page 32
- Union Nut
Type **FI-M** Page 33
- 37° Flared Tube Fitting Set
Type **FI-AB** Page 37

Spare Parts / Accessories

- O-Ring
Type **O-RING** Page 239



Adjustable Branch Tee with 24° Taper / O-Ring (DKO)
Type FI-ETD ▪ Series L / S

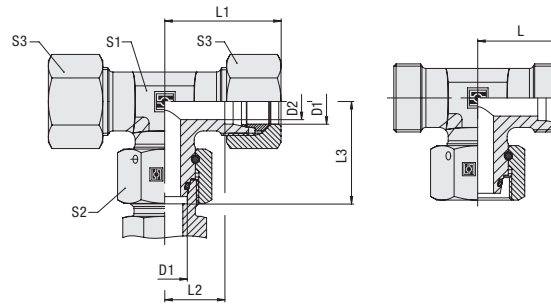

Ordering Codes

***FI-ETD*-10*L*-V*-W3*-DKO*-MS**

- * Adjustable Branch Tee with 24° Taper / O-Ring (DKO) **FI-ETD**
 - * Outside Tube Diameter D1 (in mm) **-10**
 - * Series **L**
S
 - * Seal Material **-V**
-MS
-MSV
 - * Material Code **-W3**
 - * Assembling / Kitting **-DKO**
-MS
-MSV
- Please contact STAUFF for alternative materials and surface finishings.
- Fitting body supplied with swivel nut and O-ring
- Fitting body supplied with cutting ring and union nut
- Fitting body supplied with soft-sealing cutting ring and union nut

Series	Tube OD mm D1	PN bar	Dimensions mm								Weight kg ca. per 100	Ordering Codes ³
			D2	L	L1 ¹	L2	L3	S1	S2	S3		
L	6	500	4	19	27	12	26	12	14	14	3,02	FI-ETD-06L-V-W3-DKO
	8	500	6	21	29	14	27,5	12	17	17	4,82	FI-ETD-08L-V-W3-DKO
	10	500	8	22	30	15	29	14	19	19	6,27	FI-ETD-10L-V-W3-DKO
	12	400	10	24	32	17	29,5	17	22	22	8,73	FI-ETD-12L-V-W3-DKO
	15	400	12	28	36	21	32,5	19	27	27	14,55	FI-ETD-15L-V-W3-DKO
	18	400	15	31	40	23,5	35,5	24	32	32	20,89	FI-ETD-18L-V-W3-DKO
	22	400	19	35	44	27,5	38,5	27	36	36	28,27	FI-ETD-22L-V-W3-DKO
	28	250	24	38	47	30,5	41,5	36	41	41	39,85	FI-ETD-28L-V-W3-DKO
	35	250	30	45	56	34,5	51	41	50	50	64,20	FI-ETD-35L-V-W3-DKO
	42	250	36	51	63	40	56	50	60	60	94,90	FI-ETD-42L-V-W3-DKO
	S	6	800	4	23	31	16	27	12	17	17	5,99
8		800	5	24	32	17	27,5	14	19	19	7,80	FI-ETD-08S-V-W3-DKO
10		800	7	25	34	17,5	30	17	22	22	10,60	FI-ETD-10S-V-W3-DKO
12		630	8	29	38	21,5	31	17	24	24	13,63	FI-ETD-12S-V-W3-DKO
14		630	10	30	40	22	35	19	27	27	17,37	FI-ETD-14S-V-W3-DKO
16		630	12	33	43	24,5	36,5	24	30	30	22,95	FI-ETD-16S-V-W3-DKO
20		420	16	37	48	26,5	44,5	27	36	36	35,51	FI-ETD-20S-V-W3-DKO
25		420	20	42	54	30	50	36	46	46	62,40	FI-ETD-25S-V-W3-DKO
30		420	25	49	62	35,5	55	41	50	50	85,60	FI-ETD-30S-V-W3-DKO
38		420	32	57	72	41	63	50	60	60	128,10	FI-ETD-38S-V-W3-DKO

¹ Approximate dimension in assembled condition.
² Weight excluding cutting ring and union nut.
³ Standard scope of delivery: Fitting body only.



Typical application with a Straight Male Stud Fitting FI-GE-...

Standard seal material is FKM (Viton®).

Connecting Parts

- Cutting Ring
Type **FI-DS** Page 28
- Soft-Sealing Cutting Ring
Type **FI-WDDS** Page 29
- Support Sleeve
Type **FI-VH** Page 31
- STAUFF Form EVO Sealing Ring
Type **FI-FD** Page 32
- Union Nut
Type **FI-M** Page 33
- 37° Flared Tube Fitting Set
Type **FI-AB** Page 37

Spare Parts / Accessories

- O-Ring
Type **O-RING** Page 239



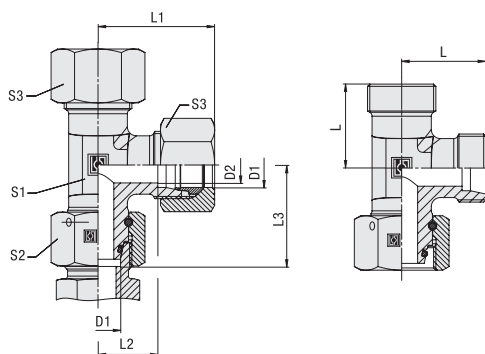

Adjustable Barrel Tee with 24° Taper / O-Ring (DKO) Type FI-ELD • Series L / S



Series	Tube OD mm	PN bar	Dimensions mm							Weight kg ca. per 100	Ordering Codes ³	
			D1	D2	L	L ¹	L2	L3	S1			S2
L	6	500	4	19	27	12	26	12	14	14	4,79	FI-ELD-06L-V-W3-DKO
	8	500	6	21	29	14	27,5	12	17	17	4,88	FI-ELD-08L-V-W3-DKO
	10	500	8	22	30	15	29	14	19	19	6,45	FI-ELD-10L-V-W3-DKO
	12	400	10	24	32	17	29,5	17	22	22	8,58	FI-ELD-12L-V-W3-DKO
	15	400	12	28	36	21	32,5	19	27	27	14,60	FI-ELD-15L-V-W3-DKO
	18	400	15	31	40	23,5	35,5	24	32	32	20,83	FI-ELD-18L-V-W3-DKO
	22	400	19	35	44	27,5	38,5	27	36	36	28,02	FI-ELD-22L-V-W3-DKO
	28	250	24	38	47	30,5	41,5	36	41	41	39,66	FI-ELD-28L-V-W3-DKO
	35	250	30	45	56	34,5	51	41	50	50	64,60	FI-ELD-35L-V-W3-DKO
	42	250	36	51	63	40	56	50	60	60	94,70	FI-ELD-42L-V-W3-DKO
S	6	800	4	23	31	16	27	12	17	17	6,04	FI-ELD-06S-V-W3-DKO
	8	800	5	24	32	17	27,5	14	19	19	8,14	FI-ELD-08S-V-W3-DKO
	10	800	7	25	34	17,5	30	17	22	22	10,53	FI-ELD-10S-V-W3-DKO
	12	630	8	29	38	21,5	31	17	24	24	13,80	FI-ELD-12S-V-W3-DKO
	14	630	10	30	40	22	35	19	27	27	20,27	FI-ELD-14S-V-W3-DKO
	16	630	12	33	43	24,5	36,5	24	30	30	23,13	FI-ELD-16S-V-W3-DKO
	20	420	16	37	48	26,5	44,5	27	36	36	35,53	FI-ELD-20S-V-W3-DKO
	25	420	20	42	54	30	50	36	46	46	61,90	FI-ELD-25S-V-W3-DKO
	30	420	25	49	62	35,5	55	41	50	50	85,10	FI-ELD-30S-V-W3-DKO
	38	420	32	57	72	41	63	50	60	60	128,00	FI-ELD-38S-V-W3-DKO

Ordering Codes

FI-ELD-10*L*-V*-W3*-DKO*-MS

- * Adjustable Barrel Tee with 24° Taper / O-Ring (DKO) FI-ELD
 - * Outside Tube Diameter D1 (in mm) -10
 - * Series Light Series L
Heavy Series S
 - * Seal Material FKM (Viton®) -V
 - * Material Code Steel, zinc/nickel-plated -W3
- Please contact STAUFF for alternative materials and surface finishings.
- * Assembling / Kitting Fitting body supplied with swivel nut and O-ring -DKO
Fitting body supplied with cutting ring and union nut -MS
Fitting body supplied with soft-sealing cutting ring and union nut -MSV

¹ Approx.imate dimension in assembled condition.

² Weight excluding cutting ring and union nut.

³ Standard scope of delivery: Fitting body only.

Standard seal material is FKM (Viton®).



Typical application with a Straight Male Stud Fitting FI-GE-...

Connecting Parts





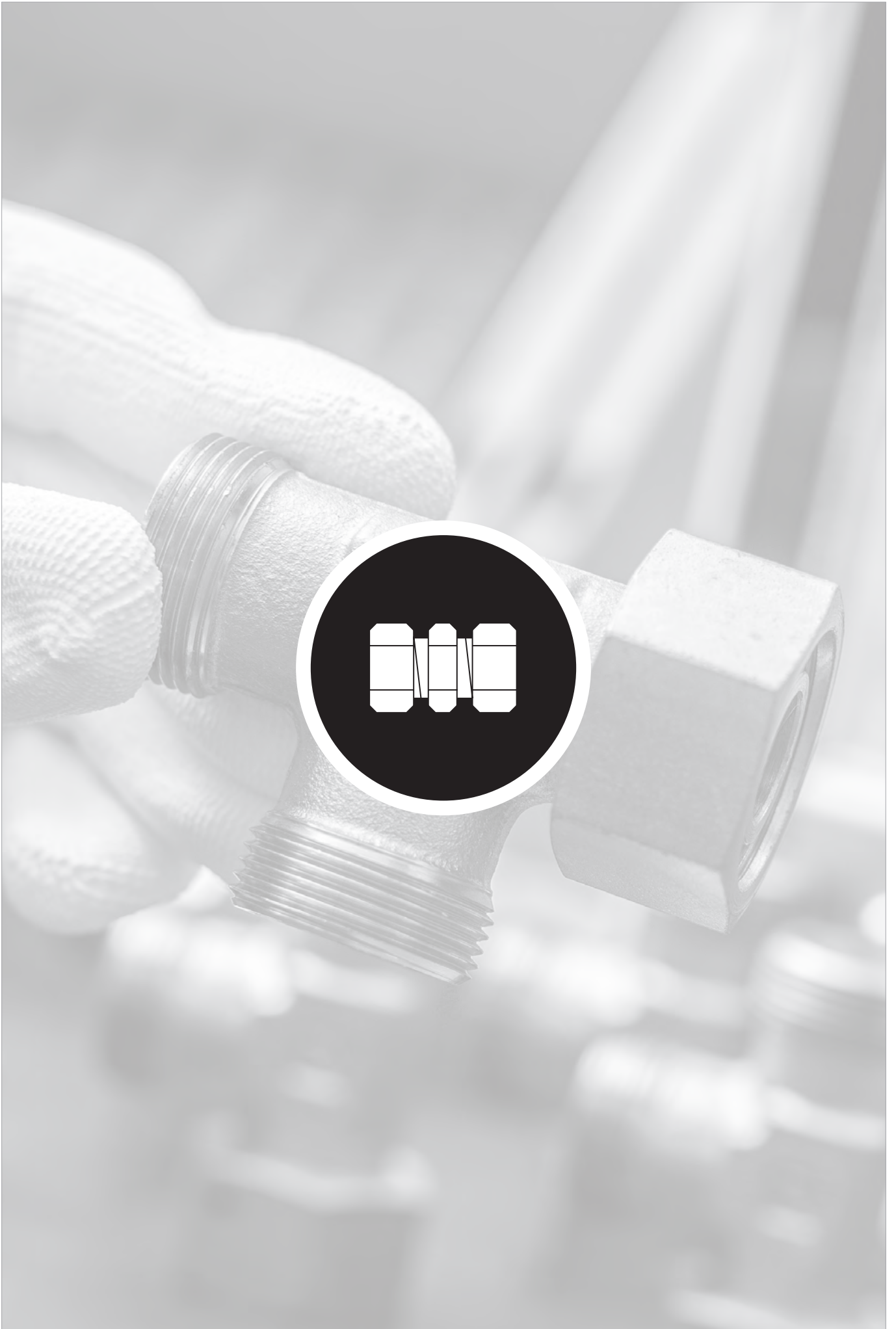

-  Cutting Ring
Type **FI-DS** Page 28
-  Soft-Sealing Cutting Ring
Type **FI-WDDS** Page 29
-  Support Sleeve
Type **FI-VH** Page 31
-  STAUFF Form EVO Sealing Ring
Type **FI-FD** Page 32
-  Union Nut
Type **FI-M** Page 33
-  37° Flared Tube Fitting Set
Type **FI-AB** Page 37

Spare Parts / Accessories

-  O-Ring
Type **O-RING** Page 239





	Straight Male Stud Standpipe Fitting	156-161
	FI-EGE	
	Whitworth Parallel Pipe Thread (BSPP) / Metallic Sealing Edge	156
	FI-EGE-...-R	
	Metric Parallel Thread / Metallic Sealing Edge	157
	FI-EGE-...-M	
	Whitworth Parallel Pipe Thread (BSPP) / Profile Sealing Ring	158
	FI-EGE-...-R-WD	
	Metric Parallel Thread / Profile Sealing Ring	160
	FI-EGE-...-M-WD	
	NPT Thread	161
	FI-EGE-...-N	
	Straight Standpipe Reducer	162
	FI-REDS	
	Adjustable Standpipe Elbow	166
	FI-EW	
	Adjustable Standpipe Branch Tee	167
	FI-ET	
	Adjustable Standpipe Barrel Tee	168
	FI-EL	



Straight Male Stud Standpipe Fitting Type FI-EGE-...-R • Series L / S

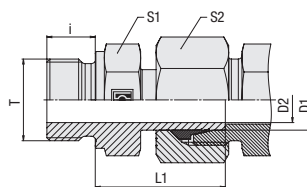

Ordering Codes

***FI-EGE*-10*L*R*-W3*-SV**

- * Straight Male Stud Standpipe Fitting **FI-EGE**
- * Outside Tube Diameter D1 (in mm) **-10**
- * Series **L**
S
- * Thread Type **R**
R
- If required, please indicate special sizes, e.g. R1/8!
- * Material Code **-W3**
-W3
- Please contact STAUFF for alternative materials and surface finishings.
- * Assembling / Kitting **-SV**
-SV

Whitworth Parallel Pipe Thread (BSPP)

Metallic Sealing Edge

Series	Tube OD mm D1	PN (PB) bar	Dimensions mm						Torque N-m Thread T	Weight kg ca. per 100 ¹	Ordering Codes ²
			Thread T	D2	i	L1	S1	S2			
L	6	PN400	G 1/8	3,5	8	24,5	14	14	25	2,50	FI-EGE-06LR-W3-SV
	8	PN400	G 1/4	4,5	12	29,5	19	17	55	5,53	FI-EGE-08LR-W3-SV
	10	PN400	G 1/4	7	12	27,5	19	19	55	5,11	FI-EGE-10LR-W3-SV
	12	PN400	G 3/8	7,5	12	34	22	22	95	8,25	FI-EGE-12LR-W3-SV
	15	PN400	G 1/2	11	14	32	27	27	185	13,02	FI-EGE-15LR-W3-SV
	18	PN400	G 1/2	14	14	31,5	27	32	185	13,86	FI-EGE-18LR-W3-SV
	22	PN250	G 3/4	18	16	32,5	32	36	250	19,98	FI-EGE-22LR-W3-SV
	28	PN250	G 1	23	18	35	41	41	400	27,39	FI-EGE-28LR-W3-SV
	35	PN250	G 1 1/4	29,5	20	42,5	50	50	670	47,03	FI-EGE-35LR-W3-SV
	42	PN250	G 1 1/2	35,5	22	46,5	55	60	800	72,00	FI-EGE-42LR-W3-SV
S	6	PB630	G 1/4	3,5	12	27	19	17	80	4,98	FI-EGE-06SR-W3-SV
	8	PB630	G 1/4	4,5	12	29,5	19	19	80	5,98	FI-EGE-08SR-W3-SV
	10	PB630	G 3/8	6,5	12	32	22	22	130	8,81	FI-EGE-10SR-W3-SV
	12	PB630	G 3/8	7,5	12	34	22	24	130	10,01	FI-EGE-12SR-W3-SV
	14	PB630	G 1/2	9,5	14	36,5	27	27	220	13,95	FI-EGE-14SR-W3-SV
	16	PB400	G 1/2	11,5	14	37	27	30	220	16,94	FI-EGE-16SR-W3-SV
	20	PB400	G 3/4	15,5	16	43	32	36	350	26,98	FI-EGE-20SR-W3-SV
	25	PB400	G 1	18	18	48	41	46	700	49,03	FI-EGE-25SR-W3-SV
	30	PB400	G 1 1/4	23,5	20	51	50	50	850	69,13	FI-EGE-30SR-W3-SV
	38	PB250	G 1 1/2	29	22	60	55	60	1000	98,20	FI-EGE-38SR-W3-SV

¹Weight including cutting ring and union nut on the standpipe.

²Standard scope of delivery: Fitting body assembled with cutting ring and union nut on the standpipe.

Please note: Standpipes are always factory-assembled with cutting rings and union nuts.

The union nut assembled on the standpipe has to be tightened by only 1/12 a turn (equivalent to 30°) beyond the fixed point.

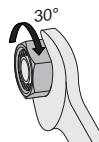

Male stud acc. to DIN 3852-2 (Form B) / ISO 1179-4 (Type B)
Port acc. to DIN 3852-2 (Form X) / ISO 1179-1

Torque recommendations for Steel mating material.

Male threaded studs were designed for female threaded ports in components made of steel. For applications with components made of softer mating materials (e.g. Aluminium), the use of connectors with additionally rolled male threads is recommended. Please contact STAUFF prior to the assembly for further information.

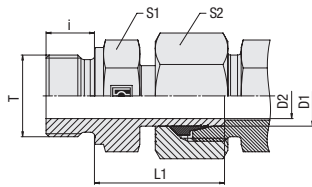

**Straight Male Stud Standpipe Fitting
Type FI-EGE-...-M • Series L / S**

Metallic Sealing Edge
Metric Parallel Thread

Series	Tube OD mm	PN (PB) bar	Dimensions mm	Thread	T	D2	i	L1	S1	S2	Torque N·m	Weight kg ca. per 100 ¹	Ordering Codes ²
L	6	PN315	M 10 x 1	3,5	8	24,5	14	14	950	2,54	FI-EGE-06LM-W3-SV		
	8	PN315	M 12 x 1,5	5,5	12	26,5	17	17	35	4,34	FI-EGE-08LM-W3-SV		
	10	PN315	M 14 x 1,5	7	12	27,5	19	19	55	5,29	FI-EGE-10LM-W3-SV		
	12	PN315	M 16 x 1,5	9	12	30,5	22	22	80	7,95	FI-EGE-12LM-W3-SV		
	15	PN315	M 18 x 1,5	11	12	31,5	24	27	100	10,25	FI-EGE-15LM-W3-SV		
	18	PN315	M 22 x 1,5	14	14	31,5	27	32	170	14,82	FI-EGE-18LM-W3-SV		
	22	PN160	M 26 x 1,5	18	16	32,5	32	36	230	19,57	FI-EGE-22LM-W3-SV		
	28	PN160	M 33 x 2	23	18	35	41	41	400	28,94	FI-EGE-28LM-W3-SV		
	35	PN160	M 42 x 2	29,5	20	42,5	50	50	700	47,56	FI-EGE-35LM-W3-SV		
	42	PN160	M 48 x 2	35,5	22	46,5	55	60	900	67,00	FI-EGE-42LM-W3-SV		
S	6	PB630	M 12 x 1,5	3,5	12	27	17	17	60	4,51	FI-EGE-06SM-W3-SV		
	8	PB630	M 14 x 1,5	4,5	12	29,5	19	19	90	6,30	FI-EGE-08SM-W3-SV		
	10	PB630	M 16 x 1,5	6,5	12	32	22	22	120	8,79	FI-EGE-10SM-W3-SV		
	12	PB630	M 18 x 1,5	7,5	12	34	24	24	190	11,24	FI-EGE-12SM-W3-SV		
	14	PB630	M 20 x 1,5	9,5	14	36,5	27	27	280	15,53	FI-EGE-14SM-W3-SV		
	16	PB400	M 22 x 1,5	11,5	14	37	27	30	300	17,47	FI-EGE-16SM-W3-SV		
	20	PB400	M 27 x 2	15,5	16	43	32	36	420	27,28	FI-EGE-20SM-W3-SV		
	25	PB400	M 33 x 2	18	18	48	41	46	600	51,00	FI-EGE-25SM-W3-SV		
	30	PB400	M 42 x 2	23,5	20	51	50	50	700	69,54	FI-EGE-30SM-W3-SV		
	38	PB315	M 48 x 2	29	22	60	55	60	900	99,38	FI-EGE-38SM-W3-SV		

Ordering Codes
***FI-EGE*-10*L*M*-W3*-SV**

- * Straight Male Stud Standpipe Fitting FI-EGE
- * Outside Tube Diameter D1 (in mm) -10
- * Series L
S
 - Light Series
 - Heavy Series
- * Thread Type M
 - Metric Parallel Thread
- If required, please indicate special sizes, e.g. M12x1.5!
- * Material Code -W3
 - Steel, zinc/nickel-plated
- Please contact STAUFF for alternative materials and surface finishings.
- * Assembling / Kitting -SV
 - Fitting body assembled with cutting ring and union nut on the standpipe

¹ Weight including cutting ring and union nut on the standpipe.

² Standard scope of delivery: Fitting body assembled with cutting ring and union nut on the standpipe.

Please note: Standpipes are always factory-assembled with cutting rings and union nuts.

The union nut assembled on the standpipe has to be tightened by only 1/12 a turn (equivalent to 30°) beyond the fixed point.

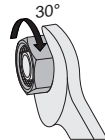

Male stud acc. to DIN 3852-1 (Form B) / ISO 9974-3 (Type B)
Port acc. to DIN 3852-1 (Form X) / ISO 9974-1

Torque recommendations for Steel mating material.

Male threaded studs were designed for female threaded ports in components made of steel. For applications with components made of softer mating materials (e.g. Aluminium), the use of connectors with additionally rolled male threads is recommended.

Please contact STAUFF prior to the assembly for further information.



Straight Male Stud Standpipe Fitting
Type FI-EGE-...-R-WD • Series L / S

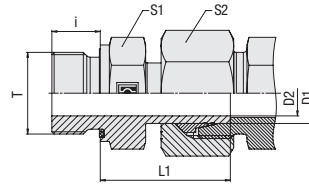

Ordering Codes

***FI-EGE*-10*L*R*-WD*-B*-W3*-SV**

- * Straight Male Stud Standpipe Fitting **FI-EGE**
 - * Outside Tube Diameter D1 (in mm) **-10**
 - * Series Light Series (page 158) **L**
Heavy Series (page 159) **S**
 - * Thread Type Whitworth Parallel Pipe Thread (BSPP) **R**
 - If required, please indicate special sizes, e.g. R1/8!
 - * Seal Type Profile Sealing Ring **-WD**
 - * Seal Material NBR (Buna-N®) **-B**
FKM (Viton®) **-V**
 - * Material Code Steel, zinc/nickel-plated **-W3**
- Please contact STAUFF for alternative materials and surface finishings.
- * Assembling / Kitting Fitting body assembled with cutting ring and union nut on the standpipe **-SV**

Spare Parts / Accessories



Profile Sealing Ring
 Type **WDG**

Page 238

Whitworth Parallel Pipe Thread (BSPP)

Profile Sealing Ring

Series	Tube OD mm D1	PN bar	Dimensions mm						Torque N-m Thread T	Weight kg ca. per 100 ¹	Ordering Codes ²
			Thread T	D2	i	L1	S1	S2			
L	6	315	G 1/8	3,5	8	24,5	14	14	18	2,29	FI-EGE-06LR-WD-B-W3-SV
	8	315	G 1/4	4,5	12	29,5	19	17	35	4,43	FI-EGE-08LR-WD-B-W3-SV
	10	315	G 1/4	7	12	27,5	19	19	35	5,04	FI-EGE-10LR-WD-B-W3-SV
	10	315	G 3/8	6	12	27,5	22	19	70	5,91	FI-EGE-10LR3/8-WD-B-W3-SV
	10	315	G 1/2	6	14	34,5	27	19	90	10,04	FI-EGE-10LR1/2-WD-B-W3-SV
	12	315	G 1/4	7	12	27,5	19	22	35	6,07	FI-EGE-12LR1/4-WD-B-W3-SV
	12	315	G 3/8	7,5	12	34	22	22	70	9,23	FI-EGE-12LR-WD-B-W3-SV
	12	315	G 1/2	7	14	34,5	27	22	90	12,86	FI-EGE-12LR1/2-WD-B-W3-SV
	15	315	G 3/8	10	12	31	22	27	70	9,72	FI-EGE-15LR3/8-WD-B-W3-SV
	15	315	G 1/2	11	14	32	27	27	90	13,01	FI-EGE-15LR-WD-B-W3-SV
	18	315	G 1/2	14	14	31,5	27	32	90	13,89	FI-EGE-18LR-WD-B-W3-SV
	18	315	G 3/4	13	16	31,5	32	32	180	18,26	FI-EGE-18LR3/4-WD-B-W3-SV
	22	160	G 3/4	18	16	32,5	32	36	180	19,63	FI-EGE-22LR-WD-B-W3-SV
	28	160	G 1	23	18	35	41	41	310	28,64	FI-EGE-28LR-WD-B-W3-SV
	35	160	G 1 1/4	29,5	20	42,5	50	50	450	46,03	FI-EGE-35LR-WD-B-W3-SV
	42	160	G 1 1/2	35,5	22	46,5	55	60	540	69,40	FI-EGE-42LR-WD-B-W3-SV

¹ Weight including cutting ring and union nut on the standpipe.

² Standard scope of delivery: Fitting body assembled with cutting ring and union nut on the standpipe.

Please note: Standpipes are always factory-assembled with cutting rings and union nuts.

The union nut assembled on the standpipe has to be tightened by only 1/12 a turn (equivalent to 30°) beyond the fixed point.

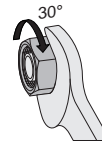

Male stud acc. to ISO 1179-2 (Type E)
 Port acc. to ISO 1179-1

Torque recommendations for Steel mating material.

Male threaded studs were designed for female threaded ports in components made of steel. For applications with components made of softer mating materials (e.g. Aluminium), the use of connectors with additionally rolled male threads is recommended.
 Please contact STAUFF prior to the assembly for further information.

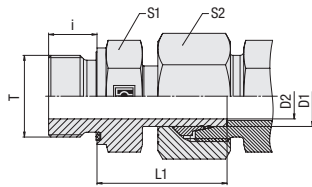

**Straight Male Stud Standpipe Fitting
Type FI-EGE-...-R-WD • Series L / S**

Whitworth Parallel Pipe Thread (BSPP)
Profile Sealing Ring

Series	Tube OD mm	PN bar	Dimensions mm						Torque N-m	Weight kg ca. per 100 ¹	Ordering Codes ²
			Thread T	D2	i	L1	S1	S2			
S	6	630	G 1/4	3,5	12	27	19	17	55	4,95	FI-EGE-06SR-WD-B-W3-SV
	8	630	G 1/4	4,5	12	29,5	19	19	55	5,95	FI-EGE-08SR-WD-B-W3-SV
	10	630	G 1/4	6	12	31,5	19	22	55	7,32	FI-EGE-10SR1/4-WD-B-W3-SV
	10	630	G 3/8	6,5	12	32	22	22	80	8,71	FI-EGE-10SR-WD-B-W3-SV
	12	630	G 1/4	5	12	34	19	24	55	8,98	FI-EGE-12SR1/4-WD-B-W3-SV
	12	630	G 3/8	7,5	12	34	22	24	80	10,02	FI-EGE-12SR-WD-B-W3-SV
	12	630	G 1/2	7,3	14	34,5	27	24	115	13,45	FI-EGE-12SR1/2-WD-B-W3-SV
	14	630	G 1/2	9,5	14	36,5	27	27	115	15,40	FI-EGE-14SR-WD-B-W3-SV
	16	630	G 3/8	10,5	12	37	22	30	80	13,46	FI-EGE-16SR3/8-WD-B-W3-SV
	16	400	G 1/2	11,5	14	37	27	30	115	16,88	FI-EGE-16SR-WD-B-W3-SV
	16	400	G 3/4	11,5	16	39	32	30	180	23,32	FI-EGE-16SR3/4-WD-B-W3-SV
	20	400	G 1/2	12	14	43	32	36	115	23,01	FI-EGE-20SR1/2-WD-B-W3-SV
	20	400	G 3/4	15,5	16	43	32	36	180	26,88	FI-EGE-20SR-WD-B-W3-SV
	25	400	G 1	18	18	48	41	46	310	48,81	FI-EGE-25SR-WD-B-W3-SV
	30	400	G 1 1/4	23,5	20	51	50	50	450	62,10	FI-EGE-30SR-WD-B-W3-SV
	38	315	G 1 1/2	29	22	60	55	60	540	97,70	FI-EGE-38SR-WD-B-W3-SV

Ordering Codes
***FI-EGE*-10*L*R*-WD*-B*-W3*-SV**

* Straight Male Stud Standpipe Fitting	FI-EGE
* Outside Tube Diameter D1 (in mm)	-10
* Series	Light Series (page 158) L Heavy Series (page 159) S
* Thread Type	Whitworth Parallel Pipe Thread (BSPP) R
If required, please indicate special sizes, e.g. R1/8!	
* Seal Type	Profile Sealing Ring -WD
* Seal Material	NBR (Buna-N®) -B FKM (Viton®) -V
* Material Code	Steel, zinc/nickel-plated -W3
Please contact STAUFF for alternative materials and surface finishings.	
* Assembling / Kitting	Fitting body assembled with cutting ring and union nut on the standpipe -SV

¹ Weight including cutting ring and union nut on the standpipe.

² Standard scope of delivery: Fitting body assembled with cutting ring and union nut on the standpipe.

Please note: Standpipes are always factory-assembled with cutting rings and union nuts.

The union nut assembled on the standpipe has to be tightened by only 1/12 a turn (equivalent to 30°) beyond the fixed point.



Male stud acc. to ISO 1179-2 (Type E)
Port acc. to ISO 1179-1

Torque recommendations for Steel mating material.

Male threaded studs were designed for female threaded ports in components made of steel. For applications with components made of softer mating materials (e.g. Aluminium), the use of connectors with additionally rolled male threads is recommended.

Please contact STAUFF prior to the assembly for further information.

Spare Parts / Accessories

Profile Sealing Ring
Type **WDG**

Page 238



Straight Male Stud Standpipe Fitting Type FI-EGE-...-M-WD • Series L / S

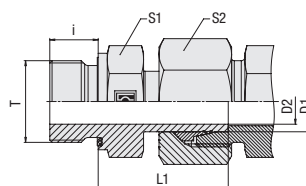

Ordering Codes

***FI-EGE*-10*L*M*-WD*-B*-W3*-SV**

- * Straight Male Stud Standpipe Fitting **FI-EGE**
- * Outside Tube Diameter D1 (in mm) **-10**
- * Series **L**
Light Series
S
Heavy Series
- * Thread Type **M**
Metric Parallel Thread
- If required, please indicate special sizes, e.g. M12x1.5!
- * Seal Type **-WD**
Profile Sealing Ring
- * Seal Material **-B**
NBR (Buna-N®)
-V
FKM (Viton®)
- * Material Code **-W3**
Steel, zinc/nickel-plated
- Please contact STAUFF for alternative materials and surface finishings.
- * Assembling / Kitting **-SV**
Fitting body assembled with cutting ring and union nut on the standpipe

Spare Parts / Accessories



Profile Sealing Ring
Type **WDG**

Page 238

Profile Sealing Ring

Metric Parallel Thread

Series	Tube OD mm D1	PN bar	Dimensions mm						Torque N-m Thread T	Weight kg ca. per 100 ¹	Ordering Codes ²	
			Thread T	D2	i	L1	S1	S2				
L	6	500	M 10 x 1	3,5	8	24,5	14	14	18	2,30	FI-EGE-06LM-WD-B-W3-SV	
	8	500	M 12 x 1,5	5,5	12	26,5	17	17	25	3,90	FI-EGE-08LM-WD-B-W3-SV	
	10	500	M 14 x 1,5	7	12	27,5	19	19	45	4,99	FI-EGE-10LM-WD-B-W3-SV	
	12	400	M 16 x 1,5	9	12	30,5	22	22	55	7,18	FI-EGE-12LM-WD-B-W3-SV	
	15	400	M 18 x 1,5	11	12	31,5	24	27	70	10,25	FI-EGE-15LM-WD-B-W3-SV	
	18	400	M 22 x 1,5	14	14	31,5	27	32	125	13,62	FI-EGE-18LM-WD-B-W3-SV	
	22	250	M 26 x 1,5	18	16	32,5	32	36	180	10,60	FI-EGE-22LM-WD-B-W3-SV	
	28	250	M 33 x 2	23	18	35	41	41	310	30,26	FI-EGE-28LM-WD-B-W3-SV	
	35	250	M 42 x 2	29,5	20	42,5	50	50	450	47,17	FI-EGE-35LM-WD-B-W3-SV	
	42	250	M 48 x 2	35,5	22	46,5	55	60	540	77,85	FI-EGE-42LM-WD-B-W3-SV	
	S	6	800	M 12 x 1,5	3,5	12	27	17	17	35	4,34	FI-EGE-06SM-WD-B-W3-SV
		8	800	M 14 x 1,5	4,5	12	29,5	19	19	55	5,90	FI-EGE-08SM-WD-B-W3-SV
10		800	M 16 x 1,5	6,5	12	32	22	22	70	8,20	FI-EGE-10SM-WD-B-W3-SV	
12		630	M 18 x 1,5	7,5	12	34	24	24	90	10,97	FI-EGE-12SM-WD-B-W3-SV	
14		630	M 20 x 1,5	9,5	14	36,5	27	27	125	15,57	FI-EGE-14SM-WD-B-W3-SV	
16		630	M 22 x 1,5	11,5	14	37	27	30	135	16,20	FI-EGE-16SM-WD-B-W3-SV	
20		400	M 27 x 2	15,5	16	43	32	36	180	27,06	FI-EGE-20SM-WD-B-W3-SV	
25		400	M 33 x 2	18	18	48	41	46	310	48,60	FI-EGE-25SM-WD-B-W3-SV	
30		400	M 42 x 2	23,5	20	51	50	50	450	69,15	FI-EGE-30SM-WD-B-W3-SV	
38		420	M 48 x 2	29	22	60	55	60	540	110,29	FI-EGE-38SM-WD-B-W3-SV	

¹ Weight including cutting ring and union nut on the standpipe.

² Standard scope of delivery: Fitting body assembled with cutting ring and union nut on the standpipe.

Please note: Standpipes are always factory-assembled with cutting rings and union nuts.

The union nut assembled on the standpipe has to be tightened by only 1/12 a turn (equivalent to 30°) beyond the fixed point.

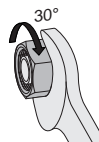

Male stud acc. to ISO 9974-2 (Type E)
Port acc. to ISO 9974-1

Torque recommendations for Steel mating material.

Male threaded studs were designed for female threaded ports in components made of steel. For applications with components made of softer mating materials (e.g. Aluminium), the use of connectors with additionally rolled male threads is recommended. Please contact STAUFF prior to the assembly for further information.

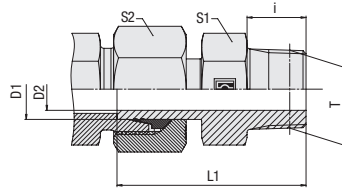

**Straight Male Stud Standpipe Fitting
Type FI-EGE-...-N • Series L / S**

NPT Thread

Series	Tube OD mm D1	PN bar	Dimensions mm						Weight kg ca. per 100 ¹	Ordering Codes ²
			Thread T	D2	i	L1	S1	S2		
L	6	315	1/8 NPT	3,3	10	33	11	14	2,27	FI-EGE-06L1/8N-W3-SV
	8	315	1/4 NPT	4	15,5	40	14	17	3,93	FI-EGE-08L1/4N-W3-SV
	10	315	1/4 NPT	6,5	15,5	41	14	19	4,46	FI-EGE-10L1/4N-W3-SV
	12	315	3/8 NPT	7	15,5	42	19	22	6,80	FI-EGE-12L3/8N-W3-SV
	15	315	1/2 NPT	10	20	46,5	22	27	10,48	FI-EGE-15L1/2N-W3-SV
	18	315	1/2 NPT	13	20	49,5	22	32	13,44	FI-EGE-18L1/2N-W3-SV
	22	160	3/4 NPT	16,5	20	49	27	36	18,41	FI-EGE-22L3/4N-W3-SV
	28	160	1 NPT	22	25	55,5	36	41	25,80	FI-EGE-28L1N-W3-SV
	35	160	1 1/4 NPT	28	25,6	74,1	46	50	42,40	FI-EGE-35L1-1/4N-W3-SV
	42	160	1 1/2 NPT	34	26	78,5	50	60	62,33	FI-EGE-42L1-1/2N-W3-SV
S	6	630	1/4 NPT	3	14	45,1	14	17	1,92	FI-EGE-06S1/4N-W3-SV
	8	630	1/4 NPT	4,3	15,5	40	14	19	4,45	FI-EGE-08S1/4N-W3-SV
	10	630	3/8 NPT	6	15,5	44,5	19	22	7,29	FI-EGE-10S3/8N-W3-SV
	12	630	3/8 NPT	7,3	15,5	46,5	19	24	8,49	FI-EGE-12S3/8N-W3-SV
	14	630	1/2 NPT	10,5	20	53,5	22	27	12,81	FI-EGE-14S1/2N-W3-SV
	16	630	1/2 NPT	13,5	20	58	22	30	16,52	FI-EGE-16S1/2N-W3-SV
	20	400	3/4 NPT	17,5	20	68	27	36	24,50	FI-EGE-20S3/4N-W3-SV
	25	400	1 NPT	17,5	25	68	36	46	41,13	FI-EGE-25S1N-W3-SV
	30	400	1 1/4 NPT	22	26	70,5	46	50	52,80	FI-EGE-30S1-1/4N-W3-SV
	38	400	1 1/2 NPT	29	26	92	50	60	83,60	FI-EGE-38S1-1/2N-W3-SV

Ordering Codes
***FI-EGE*-10*L*1/4*N*-W3*-SV**

* Straight Male Stud Standpipe Fitting	FI-EGE
* Outside Tube Diameter D1 (in mm)	-10
* Series	Light Series L Heavy Series S
* Thread Size	acc. to dimension table 1/4
Please always indicate thread sizes, e.g. 1/4!	
* Thread Type	NPT Thread N
* Material Code	Steel, zinc/nickel-plated -W3
Please contact STAUFF for alternative materials and surface finishings.	
* Assembling / Kitting	Fitting body assembled with cutting ring and union nut on the standpipe -SV

¹ Weight including cutting ring and union nut on the standpipe.

² Standard scope of delivery: Fitting body assembled with cutting ring and union nut on the standpipe.

Please note: Standpipes are always factory-assembled with cutting rings and union nuts.

The union nut assembled on the standpipe has to be tightened by only 1/12 a turn (equivalent to 30°) beyond the fixed point.



 Male stud acc. to ANSI/ASME B1.20.1-1983
 Port acc. to ANSI/ASME B1.20.1-1983

Suitable liquid / plastic sealant required.

Male threaded studs were designed for female threaded ports in components made of steel. For applications with components made of softer mating materials (e.g. Aluminium), the use of connectors with additionally rolled male threads is recommended. Please contact STAUFF prior to the assembly for further information.

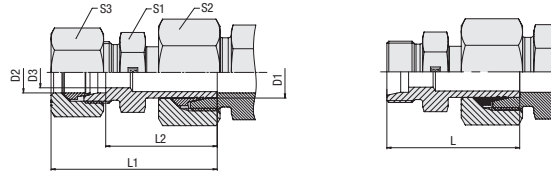

Straight Standpipe Reducer Type FI-REDS • Series L



Ordering Codes

- *FI-REDS*-10/*08*L*-W3*-MS+SV**
- * Straight Standpipe Reducer **FI-REDS**
- * Outside Tube Diameter D1 (in mm) **-10**
- * Outside Tube Diameter D2 (in mm) **08**
- * Series **L**
Light Series (pages 162/163)
Heavy Series (pages 164/165) **S**
- * Material Code **-W3**
Steel, zinc/nickel-plated
- Please contact STAUFF for alternative materials and surface finishings.
- * Assembling / Kitting **-SV**
Fitting body assembled with cutting ring and union nut on the standpipe
- MS+SV**
Fitting body assembled with cutting rings and union nuts on all ends

Series	Tube OD		PN bar	Dimensions							Weight kg ca. per 100	Ordering Codes ³
	mm D1	mm D2		mm D3	L	L1 ¹	L2	S1	S2	S3		
L / LL	6	4	100	3	32,5	38,5	28,5	10	10	10	1,96	FI-REDS-06L/04LL-W3-SV
L	8	6	500	4	33	40,5	27,5	12	17	14	3,15	FI-REDS-08/06L-W3-SV
	10	6	500	4	34	41,5	28,5	12	19	14	4,00	FI-REDS-10/06L-W3-SV
	10	8	500	6	35	42,5	28,5	14	19	17	3,97	FI-REDS-10/08L-W3-SV
	12	6	400	4	37	44,5	28	14	22	14	4,75	FI-REDS-12/06L-W3-SV
	12	8	400	6	36	44,5	29	14	22	17	5,35	FI-REDS-12/08L-W3-SV
	12	10	400	8	37	45,5	30	17	22	19	5,48	FI-REDS-12/10L-W3-SV
	15	6	400	4	38	46	28	17	27	14	7,53	FI-REDS-15/06L-W3-SV
	15	8	400	6	38	46	29	17	27	17	7,73	FI-REDS-15/08L-W3-SV
	15	10	400	8	37	47	30	17	27	19	8,24	FI-REDS-15/10L-W3-SV
	15	12	400	10	38	48	31	19	27	22	8,27	FI-REDS-15/12L-W3-SV
	18	6	400	4	37,5	45,5	30	19	32	14	10,36	FI-REDS-18/06L-W3-SV
	18	8	400	6	37,5	45,5	31	19	32	17	10,84	FI-REDS-18/08L-W3-SV
	18	10	400	8	39	46,5	32	19	32	19	10,98	FI-REDS-18/10L-W3-SV
	18	12	400	10	40,5	46,5	33,5	19	32	22	12,01	FI-REDS-18/12L-W3-SV
	18	15	400	12	41	47,5	34	24	32	27	12,76	FI-REDS-18/15L-W3-SV
	22	6	250	4	39,5	47	32	24	36	14	13,75	FI-REDS-22/06L-W3-SV
	22	8	250	6	43	46,5	34	24	36	17	19,87	FI-REDS-22/08L-W3-SV
	22	10	250	8	41	47,5	34	24	36	19	15,17	FI-REDS-22/10L-W3-SV
	22	12	250	10	39,5	47,5	34,5	24	36	22	15,45	FI-REDS-22/12L-W3-SV
	22	15	250	12	40,5	48,5	36	24	36	27	16,02	FI-REDS-22/15L-W3-SV
22	18	250	15	44	50,5	36,5	27	36	32	17,93	FI-REDS-22/18L-W3-SV	

Connecting Parts

-  Cutting Ring
Type **FI-DS** Page 28
-  Soft-Sealing Cutting Ring
Type **FI-WDDS** Page 29
-  Support Sleeve
Type **FI-VH** Page 31
-  STAUFF Form EVO Sealing Ring
Type **FI-FD** Page 32
-  Union Nut
Type **FI-M** Page 33
-  37° Flared Tube Fitting Set
Type **FI-AB** Page 37

¹ Approx.imate dimension in assembled condition.

² Weight including cutting ring and union nut on the standpipe.

³ Standard scope of delivery: Fitting body assembled with cutting ring and union nut on the standpipe.

Please note: Standpipes are always factory-assembled with cutting rings and union nuts.

The union nut assembled on the standpipe has to be tightened by only 1/12 a turn (equivalent to 30°) beyond the fixed point.

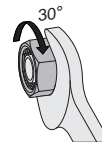

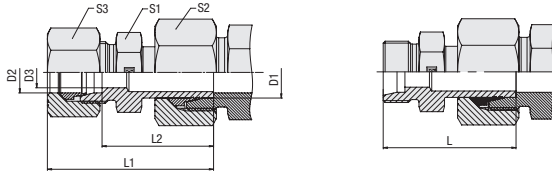
**Straight Standpipe Reducer
Type FI-REDS ■ Series L**

Series	Tube OD mm		PN bar	Dimensions mm							Weight kg ca. per 100	Ordering Codes ³
	D1	D2		D3	L	L1 ¹	L2	S1	S2	S3		
L	28	6	250	4	41	49	34,5	30	41	14	18,12	FI-REDS-28/06L-W3-SV
	28	8	250	6	42	50	34,5	30	41	17	18,24	FI-REDS-28/08L-W3-SV
	28	10	250	8	41	49	35,5	30	41	19	18,45	FI-REDS-28/10L-W3-SV
	28	12	250	10	41	49	35,5	30	41	22	19,79	FI-REDS-28/12L-W3-SV
	28	15	250	12	42	50	36,5	30	41	27	20,30	FI-REDS-28/15L-W3-SV
	28	18	250	15	43,5	52	36	30	41	32	20,48	FI-REDS-28/18L-W3-SV
	28	22	250	19	45,5	54	38	32	41	36	23,25	FI-REDS-28/22L-W3-SV
	35	6	250	4	48	56	40,5	36	50	14	29,53	FI-REDS-35/06L-W3-SV
	35	8	250	6	48	56	40,5	36	50	17	28,78	FI-REDS-35/08L-W3-SV
	35	10	250	8	49	57	41,5	36	50	19	31,70	FI-REDS-35/10L-W3-SV
	35	12	250	10	47	55	41,5	36	50	22	32,26	FI-REDS-35/12L-W3-SV
	35	15	250	12	48,5	56,5	42,5	36	50	27	28,97	FI-REDS-35/15L-W3-SV
	35	18	250	15	49,5	58,5	42	36	50	32	32,20	FI-REDS-35/18L-W3-SV
	35	22	250	19	51,5	60,5	44	36	50	36	32,94	FI-REDS-35/22L-W3-SV
	35	28	250	24	52,5	61,5	44	41	50	41	34,18	FI-REDS-35/28L-W3-SV
	42	10	250	8	51	59	45	46	60	19	45,84	FI-REDS-42/10L-W3-SV
	42	12	250	10	52	60	45	46	60	22	56,37	FI-REDS-42/12L-W3-SV
	42	15	250	12	52	60	46	46	60	27	58,28	FI-REDS-42/15L-W3-SV
	42	18	250	15	53	61	45,5	46	60	32	51,80	FI-REDS-42/18L-W3-SV
	42	22	250	19	54	63	47,5	46	60	36	58,28	FI-REDS-42/22L-W3-SV
42	28	250	24	55	64	47,5	46	60	41	52,40	FI-REDS-42/28L-W3-SV	
42	35	250	30	57	69	46,5	46	60	50	53,30	FI-REDS-42/35L-W3-SV	

¹ Approx.imate dimension in assembled condition.
² Weight including cutting ring and union nut on the standpipe.
³ Standard scope of delivery: Fitting body assembled with cutting ring and union nut on the standpipe.

Please note: Standpipes are always factory-assembled with cutting rings and union nuts.

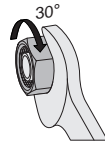

The union nut assembled on the standpipe has to be tightened by only 1/12 a turn (equivalent to 30°) beyond the fixed point.

Ordering Codes

***FI-REDS*-10/*08*L*-W3*-MS+SV**

- * Straight Standpipe Reducer **FI-REDS**
 - * Outside Tube Diameter D1 (in mm) **-10**
 - * Outside Tube Diameter D2 (in mm) **08**
 - * Series Light Series (pages 162/163) **L**
Heavy Series (pages 164/165) **S**
 - * Material Code Steel, zinc/nickel-plated **-W3**
- Please contact STAUFF for alternative materials and surface finishings.
- * Assembling / Kitting Fitting body assembled with cutting ring and union nut on the standpipe **-SV**
 - Fitting body assembled with cutting rings and union nuts on all ends **-MS+SV**

Connecting Parts

- Cutting Ring Type **FI-DS** Page 28
- Soft-Sealing Cutting Ring Type **FI-WDDS** Page 29
- Support Sleeve Type **FI-VH** Page 31
- STAUFF Form EVO Sealing Ring Type **FI-FD** Page 32
- Union Nut Type **FI-M** Page 33
- 37° Flared Tube Fitting Set Type **FI-AB** Page 37



Straight Standpipe Reducer Type FI-REDS • Series S

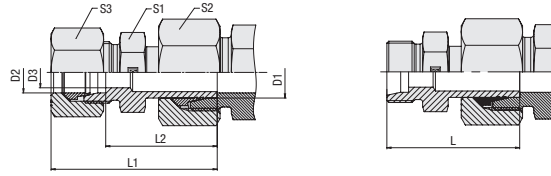

Ordering Codes

***FI-REDS*-10/*08*S*-W3*-MS+SV**

- * Straight Standpipe Reducer **FI-REDS**
- * Outside Tube Diameter D1 (in mm) **-10**
- * Outside Tube Diameter D2 (in mm) **08**
- * Series **L**
S
Light Series (pages 162/163)
Heavy Series (pages 164/165)
- * Material Code **-W3**
Steel, zinc/nickel-plated
- Please contact STAUFF for alternative materials and surface finishings.
- * Assembling / Kitting **-SV**
Fitting body assembled with cutting ring and union nut on the standpipe
- MS+SV**
Fitting body assembled with cutting rings and union nuts on all ends

Series	Tube OD mm		PN bar	Dimensions mm							Weight kg ca. per 100	Ordering Codes ³
	D1	D2		D3	L	L1 ¹	L2	S1	S2	S3		
S	8	6	800	4	37	45	30	14	19	17	4,42	FI-REDS-08/06S-W3-SV
	10	6	800	4	39	47	34	14	22	17	6,26	FI-REDS-10/06S-W3-SV
	10	8	800	5	41	49	34	17	22	19	6,81	FI-REDS-10/08S-W3-SV
	12	6	630	4	39	47	36	14	24	17	6,70	FI-REDS-12/06S-W3-SV
	12	8	630	5	41	49	31,5	17	24	19	7,46	FI-REDS-12/08S-W3-SV
	12	10	630	7	41	50	36	19	24	22	7,80	FI-REDS-12/10S-W3-SV
	14	6	630	4	42	50	37	17	27	17	9,61	FI-REDS-14/06S-W3-SV
	14	8	630	5	44	52	37	17	27	19	10,19	FI-REDS-14/08S-W3-SV
	14	10	630	7	44	53	36,5	19	27	22	11,24	FI-REDS-14/10S-W3-SV
	14	12	630	8	44	55	36,5	22	27	24	11,98	FI-REDS-14/12S-W3-SV
	16	6	630	4	45,5	50	38,5	17	30	17	12,14	FI-REDS-16/06S-W3-SV
	16	8	630	5	44	52	38,5	17	30	19	12,29	FI-REDS-16/08S-W3-SV
	16	10	630	7	44	53	38	19	30	22	12,78	FI-REDS-16/10S-W3-SV
	16	12	630	8	46	55	38	22	30	24	14,39	FI-REDS-16/12S-W3-SV
	16	14	630	10	47,5	58	39,5	24	30	27	14,70	FI-REDS-16/14S-W3-SV
	20	6	400	4	47	55	46,5	22	36	17	20,15	FI-REDS-20/06S-W3-SV
	20	8	400	5	48	56	46,5	22	36	19	17,67	FI-REDS-20/08S-W3-SV
	20	10	400	7	53,5	57	46	22	36	22	16,90	FI-REDS-20/10S-W3-SV
	20	12	400	8	50	59	46	22	36	24	18,10	FI-REDS-20/12S-W3-SV
	20	14	400	10	52	62	47,5	24	36	27	19,20	FI-REDS-20/14S-W3-SV
20	16	400	12	55,5	62	47	27	36	30	23,31	FI-REDS-20/16S-W3-SV	

Connecting Parts

- Cutting Ring
Type **FI-DS** Page 28
- Soft-Sealing Cutting Ring
Type **FI-WDDS** Page 29
- Support Sleeve
Type **FI-VH** Page 31
- STAUFF Form EVO Sealing Ring
Type **FI-FD** Page 32
- Union Nut
Type **FI-M** Page 33
- 37° Flared Tube Fitting Set
Type **FI-AB** Page 37

¹ Approximate dimension in assembled condition.

² Weight including cutting ring and union nut on the standpipe.

³ Standard scope of delivery: Fitting body assembled with cutting ring and union nut on the standpipe.

Please note: Standpipes are always factory-assembled with cutting rings and union nuts.

The union nut assembled on the standpipe has to be tightened by only 1/12 a turn (equivalent to 30°) beyond the fixed point.

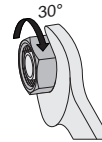

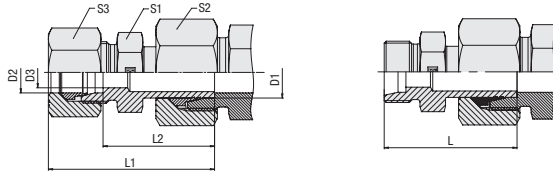
**Straight Standpipe Reducer
Type FI-REDS ■ Series S**

Series	Tube OD mm		PN bar	Dimensions mm							Weight kg ca. per 100	Ordering Codes ³
	D1	D2		D3	L	L1 ¹	L2	S1	S2	S3		
S	25	6	400	4	50	58	51	27	46	17	31,38	FI-REDS-25/06S-W3-SV
	25	8	400	5	51	59	51	27	46	19	31,65	FI-REDS-25/08S-W3-SV
	25	10	400	7	58	60	50,5	27	46	22	35,51	FI-REDS-25/10S-W3-SV
	25	12	400	8	53	62	50,5	27	46	24	38,88	FI-REDS-25/12S-W3-SV
	25	14	400	10	60	65	52	27	46	27	41,86	FI-REDS-25/14S-W3-SV
	25	16	400	12	60	65	51,5	27	46	30	35,70	FI-REDS-25/16S-W3-SV
	25	20	400	16	62	70	51,5	32	46	36	39,99	FI-REDS-25/20S-W3-SV
	30	6	400	4	53	61	52,5	32	50	17	42,88	FI-REDS-30/06S-W3-SV
	30	8	400	5	53	61	52,5	32	50	19	38,19	FI-REDS-30/08S-W3-SV
	30	10	400	7	53	62	52	32	50	22	43,13	FI-REDS-30/10S-W3-SV
	30	12	400	8	59,5	65	52	32	50	24	38,53	FI-REDS-30/12S-W3-SV
	30	14	400	10	61,5	68	53,5	32	50	27	39,19	FI-REDS-30/14S-W3-SV
	30	16	400	12	61,5	68	53	32	50	30	43,00	FI-REDS-30/16S-W3-SV
	30	20	400	16	62	73	53	32	50	36	55,33	FI-REDS-30/20S-W3-SV
	30	25	400	20	66	78	53,5	41	50	46	52,60	FI-REDS-30/25S-W3-SV
	38	6	315	4	60	68	56	41	60	17	64,17	FI-REDS-38/06S-W3-SV
	38	8	315	5	60	68	56	41	60	19	64,88	FI-REDS-38/08S-W3-SV
	38	10	315	7	62	71	55,5	41	60	22	63,89	FI-REDS-38/10S-W3-SV
	38	12	315	8	62	69	55,5	41	60	24	64,80	FI-REDS-38/12S-W3-SV
	38	14	315	10	65	75	57	41	60	27	67,79	FI-REDS-38/14S-W3-SV
38	16	315	12	65	74	56,5	41	60	30	64,60	FI-REDS-38/16S-W3-SV	
38	20	315	16	68	79	56,5	41	60	36	72,99	FI-REDS-38/20S-W3-SV	
38	25	315	20	69	84	57	41	60	46	66,80	FI-REDS-38/25S-W3-SV	
38	30	315	25	74	87	57,5	46	60	50	71,80	FI-REDS-38/30S-W3-SV	

¹ Approx.imate dimension in assembled condition.
² Weight including cutting ring and union nut on the standpipe.
³ Standard scope of delivery: Fitting body assembled with cutting ring and union nut on the standpipe.

Please note: Standpipes are always factory-assembled with cutting rings and union nuts.

The union nut assembled on the standpipe has to be tightened by only 1/12 a turn (equivalent to 30°) beyond the fixed point.

Ordering Codes
***FI-REDS*-10/*08*S*-W3*-MS+SV**

- * Straight Standpipe Reducer **FI-REDS**
 - * Outside Tube Diameter D1 (in mm) **-10**
 - * Outside Tube Diameter D2 (in mm) **08**
 - * Series Light Series (pages 162/163) **L**
Heavy Series (pages 164/165) **S**
 - * Material Code Steel, zinc/nickel-plated **-W3**
- Please contact STAUFF for alternative materials and surface finishings.
- * Assembling / Kitting Fitting body assembled with cutting ring and union nut on the standpipe **-SV**
 - Fitting body assembled with cutting rings and union nuts on all ends **-MS+SV**

Connecting Parts

-  Cutting Ring
Type **FI-DS** Page 28
-  Soft-Sealing Cutting Ring
Type **FI-WDDS** Page 29
-  Support Sleeve
Type **FI-VH** Page 31
-  STAUFF Form EVO Sealing Ring
Type **FI-FD** Page 32
-  Union Nut
Type **FI-M** Page 33
-  37° Flared Tube Fitting Set
Type **FI-AB** Page 37



Adjustable Standpipe Elbow Type FI-EW ▪ Series L / S

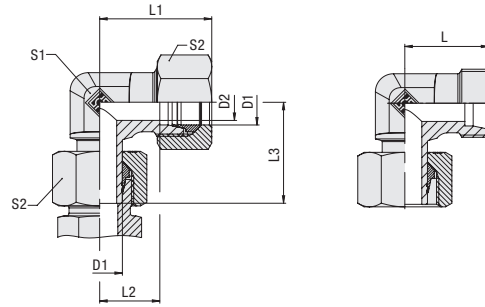

Ordering Codes

***FI-EW*-10*L*-W3*-MS+SV**

- * Adjustable Standpipe Elbow **FI-EW**
- * Outside Tube Diameter D1 (in mm) **-10**
- * Series **L**
Light Series
S
Heavy Series
- * Material Code **-W3**
Steel, zinc/nickel-plated
- Please contact STAUFF for alternative materials and surface finishings.
- * Assembling / Kitting **-SV**
Fitting body assembled with cutting ring and union nut on the standpipe
- MS+SV**
Fitting body assembled with cutting rings and union nuts on all ends

Series	Tube OD	PN bar	Dimensions							Weight kg ca. per 100	Ordering Codes ³
	mm D1		mm D2	L	L1 ¹	L2	L3	S1	S2		
L	6	500	4	19	27	12	26	12	14	2,89	FI-EW-06L-W3-SV
	8	500	6	21	29	14	27,5	12	17	3,89	FI-EW-08L-W3-SV
	10	500	8	22	30	15	29	14	19	5,20	FI-EW-10L-W3-SV
	12	400	10	24	32	17	29,5	17	22	7,20	FI-EW-12L-W3-SV
	15	400	12	28	36	21	32,5	19	27	17,20	FI-EW-15L-W3-SV
	18	400	15	31	40	23,5	35,5	24	32	17,70	FI-EW-18L-W3-SV
	22	250	19	35	44	27,5	38,5	27	36	24,00	FI-EW-22L-W3-SV
	28	250	24	38	47	30,5	41,5	36	41	35,70	FI-EW-28L-W3-SV
	35	250	30	45	56	34,5	51	41	50	58,10	FI-EW-35L-W3-SV
	42	250	36	51	63	40	56	50	60	87,00	FI-EW-42L-W3-SV
S	6	800	4	23	31	16	27	12	17	4,60	FI-EW-06S-W3-SV
	8	800	5	24	32	17	27,5	14	19	6,20	FI-EW-08S-W3-SV
	10	800	7	25	34	17,5	30	17	22	8,80	FI-EW-10S-W3-SV
	12	630	8	29	38	21,5	31	17	24	10,90	FI-EW-12S-W3-SV
	14	630	10	30	40	22	35	19	27	14,90	FI-EW-14S-W3-SV
	16	630	11	33	43	24,5	36,5	24	30	20,10	FI-EW-16S-W3-SV
	20	400	16	37	48	26,5	44,5	27	36	30,60	FI-EW-20S-W3-SV
	25	400	20	42	54	30	50	36	46	55,40	FI-EW-25S-W3-SV
	30	400	25	49	62	35,5	55	41	50	79,80	FI-EW-30S-W3-SV
	38	400	32	57	72	41	63	50	60	110,30	FI-EW-38S-W3-SV

Connecting Parts

-  Cutting Ring
Type **FI-DS** Page 28
-  Soft-Sealing Cutting Ring
Type **FI-WDDS** Page 29
-  Support Sleeve
Type **FI-VH** Page 31
-  STAUFF Form EVO Sealing Ring
Type **FI-FD** Page 32
-  Union Nut
Type **FI-M** Page 33
-  37° Flared Tube Fitting Set
Type **FI-AB** Page 37

¹ Approx.imate dimension in assembled condition.

² Weight including cutting ring and union nut on the standpipe.

³ Standard scope of delivery: Fitting body assembled with cutting ring and union nut on the standpipe.



Typical application with a Straight Male Stud Fitting FI-GE-...

Please note: Standpipes are always factory-assembled with cutting rings and union nuts.

The union nut assembled on the standpipe has to be tightened by only 1/12 a turn (equivalent to 30°) beyond the fixed point.

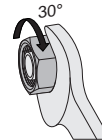

Adjustable Standpipe Branch Tee Type FI-ET ■ Series L / S

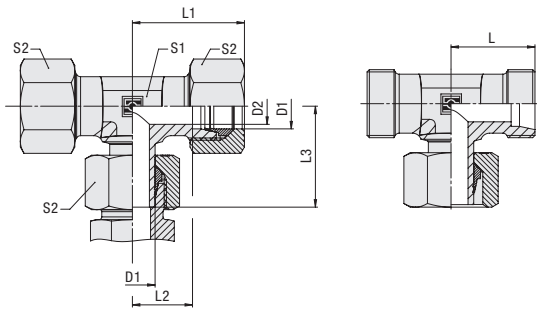

Series	Tube OD mm	PN bar	Dimensions mm							Weight kg ca. per 100	Ordering Codes ³
			D1	D2	L	L1 ¹	L2	L3	S1		
L	6	500	4	19	27	12	26	12	14	3,60	FI-ET-06L-W3-SV
	8	500	6	21	29	14	27,5	12	17	4,70	FI-ET-08L-W3-SV
	10	500	8	22	30	15	29	14	19	6,10	FI-ET-10L-W3-SV
	12	400	10	24	32	17	29,5	17	22	8,30	FI-ET-12L-W3-SV
	15	400	12	28	36	21	32,5	19	27	14,40	FI-ET-15L-W3-SV
	18	400	15	31	40	23,5	35,5	24	32	20,70	FI-ET-18L-W3-SV
	22	250	19	35	44	27,5	38,5	27	36	29,30	FI-ET-22L-W3-SV
	28	250	24	38	47	30,5	41,5	36	41	40,80	FI-ET-28L-W3-SV
	35	250	30	45	56	34,5	51	41	50	65,00	FI-ET-35L-W3-SV
	42	250	36	51	63	40	56	50	60	87,90	FI-ET-42L-W3-SV
S	6	800	4	23	31	16	27	12	17	5,80	FI-ET-06S-W3-SV
	8	800	5	24	32	17	27,5	14	19	7,80	FI-ET-08S-W3-SV
	10	800	7	25	34	17,5	30	17	22	10,20	FI-ET-10S-W3-SV
	12	630	8	29	38	21,5	31	17	24	13,50	FI-ET-12S-W3-SV
	14	630	10	30	40	22	35	19	27	17,70	FI-ET-14S-W3-SV
	16	630	12	33	43	24,5	36,5	24	30	23,70	FI-ET-16S-W3-SV
	20	400	16	37	48	26,5	44,5	27	36	36,50	FI-ET-20S-W3-SV
	25	400	20	42	54	30	50	36	46	63,70	FI-ET-25S-W3-SV
	30	400	25	49	62	35,5	55	41	50	88,90	FI-ET-30S-W3-SV
	38	400	32	57	72	41	63	50	60	135,80	FI-ET-38S-W3-SV

Ordering Codes

***FI-ET*-10*L*-W3*-MS+SV**

- * Adjustable Standpipe Branch Tee **FI-ET**
- * Outside Tube Diameter D1 (in mm) **-10**
- * Series **L**
Light Series **L**
Heavy Series **S**
- * Material Code **-W3**
Steel, zinc/nickel-plated
- Please contact STAUFF for alternative materials and surface finishings.
- * Assembling / Kitting **-SV**
Fitting body assembled with cutting ring and union nut on the standpipe **-SV**
Fitting body assembled with cutting rings and union nuts on all ends **-MS+SV**

- ¹ Approx.imate dimension in assembled condition.
² Weight including cutting ring and union nut on the standpipe.
³ Standard scope of delivery: Fitting body assembled with cutting ring and union nut on the standpipe.



Typical application with a Straight Male Stud Fitting FI-GE-...

Please note: Standpipes are always factory-assembled with cutting rings and union nuts.

The union nut assembled on the standpipe has to be tightened by only 1/12 a turn (equivalent to 30°) beyond the fixed point.

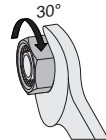

Connecting Parts

-  Cutting Ring Type **FI-DS** Page 28
-  Soft-Sealing Cutting Ring Type **FI-WDDS** Page 29
-  Support Sleeve Type **FI-VH** Page 31
-  STAUFF Form EVO Sealing Ring Type **FI-FD** Page 32
-  Union Nut Type **FI-M** Page 33
-  37° Flared Tube Fitting Set Type **FI-AB** Page 37



Adjustable Standpipe Barrel Tee Type FI-EL ▪ Series L / S

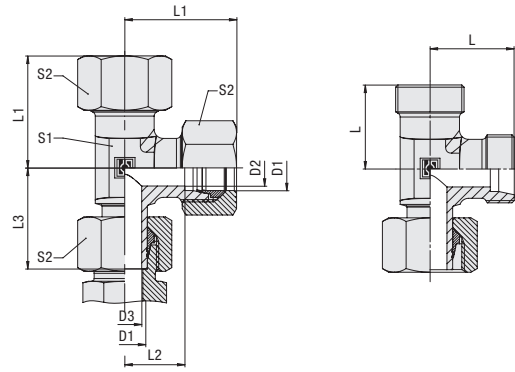

Ordering Codes

***FI-EL*-10*L*-W3*-MS+SV**

- * Adjustable Standpipe Barrel Tee FI-EL
- * Outside Tube Diameter D1 (in mm) -10
- * Series L
S
 - Light Series
 - Heavy Series
- * Material Code -W3
 - Steel, zinc/nickel-plated
- Please contact STAUFF for alternative materials and surface finishings.
- * Assembling / Kitting -SV
 - Fitting body assembled with cutting ring and union nut on the standpipe
 - Fitting body assembled with cutting rings and union nuts on all ends -MS+SV

Series	Tube OD mm D1	PN bar	Dimensions mm							Weight kg ca. per 100	Ordering Codes ³
			D2	L	L1 ¹	L2	L3	S1	S2		
L	6	500	4	19	27	12	26	12	14	3,60	FI-EL-06L-W3-SV
	8	500	6	21	29	14	27,5	12	17	4,70	FI-EL-08L-W3-SV
	10	500	8	22	30	15	29	14	19	6,10	FI-EL-10L-W3-SV
	12	400	10	24	32	17	29,5	17	22	8,30	FI-EL-12L-W3-SV
	15	400	12	28	36	21	32,5	19	27	14,40	FI-EL-15L-W3-SV
	18	400	15	31	40	23,5	35,5	24	32	20,70	FI-EL-18L-W3-SV
	22	250	19	35	44	27,5	38,5	27	36	29,30	FI-EL-22L-W3-SV
	28	250	24	38	47	30,5	41,5	36	41	40,80	FI-EL-28L-W3-SV
	35	250	30	45	56	34,5	51	41	50	65,00	FI-EL-35L-W3-SV
	42	250	36	51	63	40	56	50	60	87,90	FI-EL-42L-W3-SV
S	6	800	4	23	31	16	27	12	17	5,80	FI-EL-06S-W3-SV
	8	800	5	24	32	17	27,5	14	19	7,80	FI-EL-08S-W3-SV
	10	800	7	25	34	17,5	30	17	22	10,20	FI-EL-10S-W3-SV
	12	630	8	29	38	21,5	31	17	24	13,50	FI-EL-12S-W3-SV
	14	630	10	30	40	22	35	19	27	17,70	FI-EL-14S-W3-SV
	16	630	12	33	43	24,5	36,5	24	30	23,70	FI-EL-16S-W3-SV
	20	400	16	37	48	26,5	44,5	27	36	36,50	FI-EL-20S-W3-SV
	25	400	20	42	54	30	50	36	46	63,70	FI-EL-25S-W3-SV
	30	400	25	49	62	35,5	55	41	50	88,90	FI-EL-30S-W3-SV
	38	420	32	57	72	41	63	50	60	135,80	FI-EL-38S-W3-SV

Connecting Parts

- Cutting Ring
Type **FI-DS** Page 28
- Soft-Sealing Cutting Ring
Type **FI-WDDS** Page 29
- Support Sleeve
Type **FI-VH** Page 31
- STAUFF Form EVO Sealing Ring
Type **FI-FD** Page 32
- Union Nut
Type **FI-M** Page 33
- 37° Flared Tube Fitting Set
Type **FI-AB** Page 37

¹ Approx.imate dimension in assembled condition.

² Weight including cutting ring and union nut on the standpipe.

³ Standard scope of delivery: Fitting body assembled with cutting ring and union nut on the standpipe.



Typical application with a Straight Male Stud Fitting FI-GE-...

Please note: Standpipes are always factory-assembled with cutting rings and union nuts.

The union nut assembled on the standpipe has to be tightened by only 1/12 a turn (equivalent to 30°) beyond the fixed point.

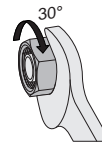

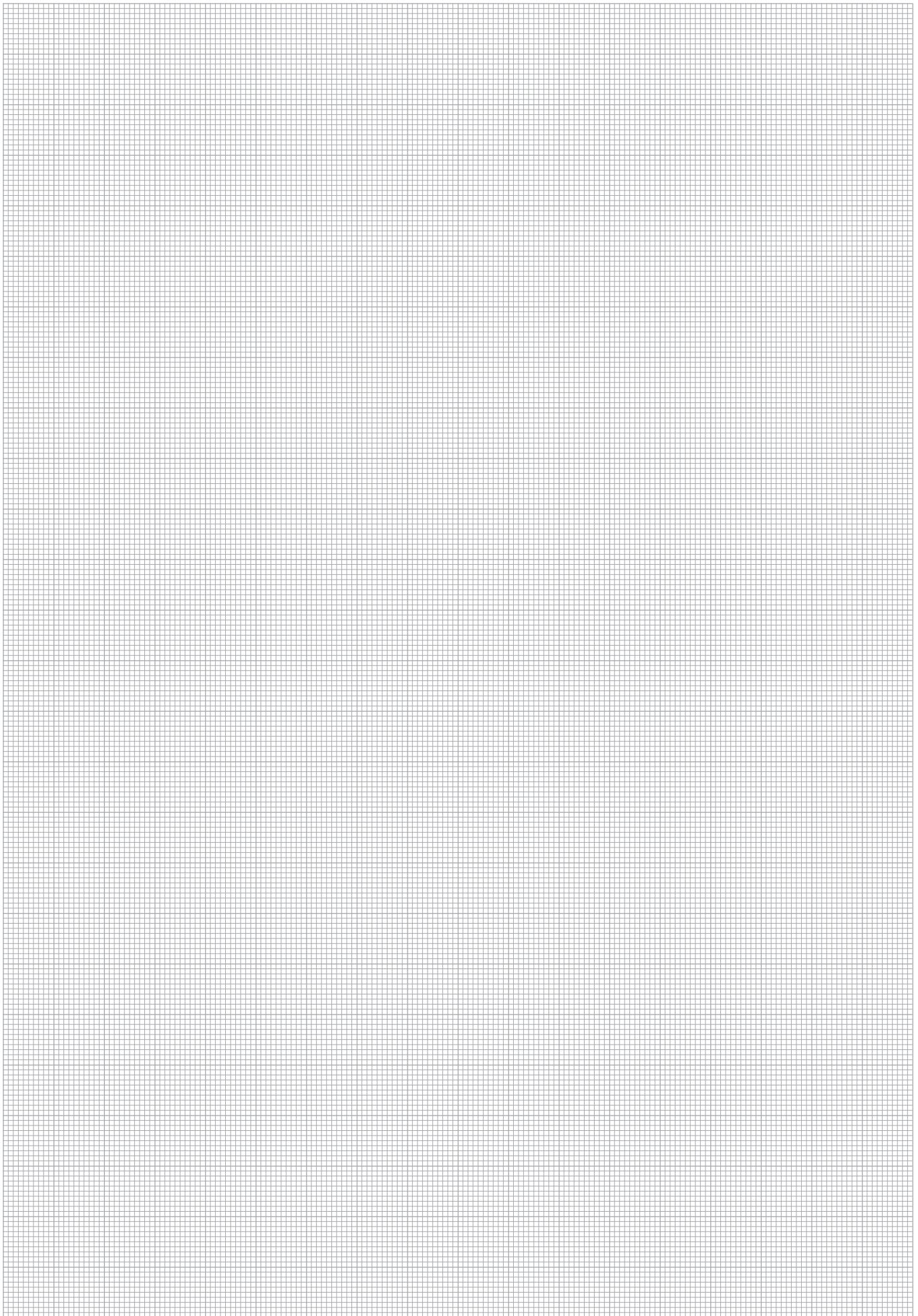



Adjustable Male Stud Elbow (90°) with Lock Nut

FI-WEE

**Whitworth Parallel Pipe Thread (BSPP) /
O-Ring and Retaining Ring (Small)**
FI-WEE-...-R-OK

172

**Metric Parallel Thread /
O-Ring and Retaining Ring (Small)**
FI-WEE-...-M-OK

174

**Metric Parallel Thread /
O-Ring**
FI-WEE-...-M-OR

176

**UN/UNF Thread /
O-Ring**
FI-WEE-...-U-OR

178

Adjustable Male Stud Elbow (45°) with Lock Nut

FI-VEE

**Whitworth Parallel Pipe Thread (BSPP) /
O-Ring and Retaining Ring (Small)**
FI-VEE-...-R-OK

173

**Metric Parallel Thread /
O-Ring and Retaining Ring (Small)**
FI-VEE-...-M-OK

175

**Metric Parallel Thread /
O-Ring**
FI-VEE-...-M-OR

177

**UN/UNF Thread /
O-Ring**
FI-VEE-...-U-OR

179

Adjustable Male Stud Branch Tee with Lock Nut

FI-TEE

**Whitworth Parallel Pipe Thread (BSPP) /
O-Ring and Retaining Ring (Small)**
FI-TEE-...-R-OK

173

**Metric Parallel Thread /
O-Ring and Retaining Ring (Small)**
FI-TEE-...-M-OK

175

**Metric Parallel Thread /
O-Ring**
FI-TEE-...-M-OR

177

**UN/UNF Thread /
O-Ring**
FI-TEE-...-U-OR

179

Adjustable Male Stud Barrel Tee with Lock Nut

FI-LEE

**Whitworth Parallel Pipe Thread (BSPP) /
O-Ring and Retaining Ring (Small)**
FI-LEE-...-R-OK

173

**Metric Parallel Thread /
O-Ring and Retaining Ring (Small)**
FI-LEE-...-M-OK

175

**Metric Parallel Thread /
O-Ring**
FI-LEE-...-M-OR

177

**UN/UNF Thread /
O-Ring**
FI-LEE-...-U-OR

179

J

Adjustable Male Stud Elbow (90°) with Lock Nut
Type FI-WEE-...-R-OK • Series L / S

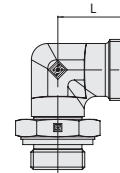
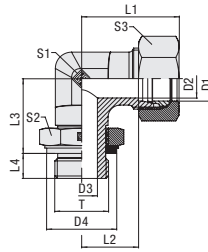

Whitworth Parallel Pipe Thread (BSPP)

O-Ring and Retaining Ring (Small)

Series	Tube OD mm D1	PN bar	Dimensions mm											Torque N-m Thread T	Weight kg ca. per 100	Ordering Codes ³	
			Thread T	D2	D3	D4	L	L1 ¹	L2	L3	L4	S1	S2				S3
L	6	315	G 1/8	4	4	14,8	21	29	14	20	7	14	14	14	25	4,06	FI-WEE-06LR-OK-B-W3
	8	315	G 1/4	6	5	19,8	23	31	16	25	9	14	19	17	50	6,34	FI-WEE-08LR-OK-B-W3
	10	315	G 1/4	8	5	19,8	24	32	17	27	9	19	19	19	50	9,17	FI-WEE-10LR-OK-B-W3
	12	250	G 3/8	10	8	22,8	26	34	19	28	9	19	22	22	80	10,39	FI-WEE-12LR-OK-B-W3
	15	250	G 1/2	12	12	27,8	28	36	21	29	13	22	27	27	105	15,73	FI-WEE-15LR-OK-B-W3
	18	250	G 1/2	15	12	27,8	31	40	23,5	33	13	27	27	32	105	22,29	FI-WEE-18LR-OK-B-W3
	22	160	G 3/4	19	16	32,8	35	44	27,5	38	13	30	36	36	220	33,01	FI-WEE-22LR-OK-B-W3
	28	160	G 1	24	20	40,8	38	47	30,5	44	15	36	41	41	370	50,60	FI-WEE-28LR-OK-B-W3
	35	160	G 1 1/4	30	25	50,8	48	59	37,5	55	15	50	50	50	500	115,30	FI-WEE-35LR-OK-B-W3
42	160	G 1 1/2	36	32	55,8	49	61	38	59	15	50	55	60	600	112,50	FI-WEE-42LR-OK-B-W3	
S	6	315	G 1/4	4	5	19,8	22	30	15	25	9	14	19	17	50	6,62	FI-WEE-06SR-OK-B-W3
	8	315	G 1/4	5	5	19,8	24	32	17	27	9	19	19	19	50	9,70	FI-WEE-08SR-OK-B-W3
	10	315	G 3/8	7	8	22,8	25	34	17,5	28	9	19	22	22	80	10,96	FI-WEE-10SR-OK-B-W3
	12	250	G 3/8	8	8	22,8	29	38	21,5	31	9	22	22	24	80	14,98	FI-WEE-12SR-OK-B-W3
	16	250	G 1/2	12	12	27,8	33	43	24,5	33	13	27	27	30	105	23,56	FI-WEE-16SR-OK-B-W3
	20	250	G 3/4	16	16	32,8	38	49	27,5	39	12	30	36	36	220	36,41	FI-WEE-20SR-OK-B-W3
	25	250	G 1	20	20	40,8	42	54	30	45	14	36	41	46	370	56,20	FI-WEE-25SR-OK-B-W3
	30	160	G 1 1/4	25	25	50,8	49	62	35,5	55	15	50	50	50	500	120,20	FI-WEE-30SR-OK-B-W3
38	160	G 1 1/2	32	32	55,8	50	65	34	59	15	50	55	60	600	120,30	FI-WEE-38SR-OK-B-W3	

¹ Approx.imate dimension in assembled condition.

² Weight excluding cutting ring and union nut.

³ Standard scope of delivery: Fitting body only.

Standard seal material is NBR (Buna-N®).

Male stud acc. to ISO 1179-3 (Type H)

Port acc. to ISO 1179-1

Torque recommendations for Steel mating material.

Male threaded studs were designed for female threaded ports in components made of steel. For applications with components made of softer mating materials (e.g. Aluminium), the use of connectors with additionally rolled male threads is recommended.

Please contact STAUFF prior to the assembly for further information.

Ordering Codes

***FI-WEE*-10*L*R*-OK*-B*-W3*-MS**

- * Adjustable Male Stud Elbow (90°) with Lock Nut **FI-WEE**
- * Outside Tube Diameter (in mm) **-10**
- * Series **L** Light Series
S Heavy Series
- * Thread Type **R** Whitworth Parallel Pipe Thread (BSPP)

- * Seal Type **-OK** O-Ring and Retaining Ring (Small)
- * Seal Material **-B** NBR (Buna-N®)
-V FKM (Viton®)
- * Material Code **-W3** Steel, zinc/nickel-plated
- Please contact STAUFF for alternative materials and surface finishings.

- * Assembling / Kitting **-** Fitting body only
- MS** Fitting body supplied with cutting ring and union nut
- MSV** Fitting body supplied with soft-sealing cutting ring and union nut

If required, please indicate special sizes, e.g. R1/8!



**Adjustable Male Stud Elbow (45°) with Lock Nut
Type FI-VEE-...-R-OK • Series L / S**
**Adjustable Male Stud Branch Tee with Lock Nut
Type FI-TEE-...-R-OK • Series L / S**
**Adjustable Male Stud Barrel Tee with Lock Nut
Type FI-LEE-...-R-OK • Series L / S**
Type FI-VEE-...-R-OK

Whitworth Parallel Pipe Thread (BSPP)
O-Ring and Retaining Ring (Small)

Male stud acc. to ISO 1179-3 (Type H)
Port acc. to ISO 1179-1

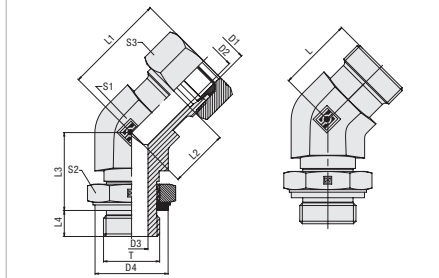

Dimensions L, L1, L2 and L3 deviating from the dimension table on the left.

Type FI-TEE-...-R-OK

Whitworth Parallel Pipe Thread (BSPP)
O-Ring and Retaining Ring (Small)

Male stud acc. to ISO 1179-3 (Type H)
Port acc. to ISO 1179-1

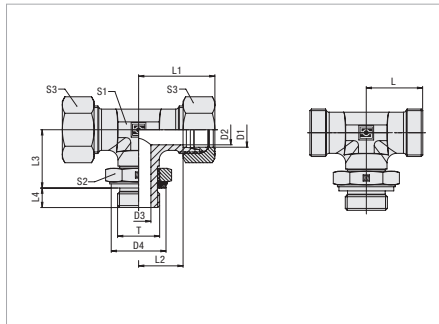
Type FI-LEE-...-R-OK

Whitworth Parallel Pipe Thread (BSPP)
O-Ring and Retaining Ring (Small)

Male stud acc. to ISO 1179-3 (Type H)
Port acc. to ISO 1179-1

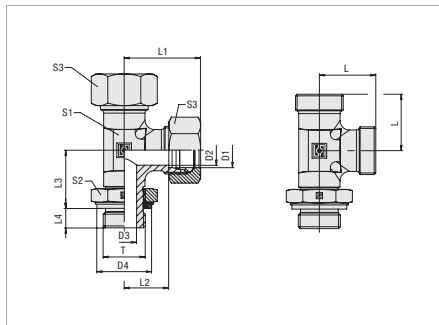

Male threaded studs were designed for female threaded ports in components made of steel. For applications with components made of softer mating materials (e.g. Aluminium), the use of connectors with additionally rolled male threads is recommended.

Please contact STAUFF prior to the assembly for further information.

Connecting Parts

Cutting Ring
Type **FI-DS** Page 28



Soft-Sealing Cutting Ring
Type **FI-WDDS** Page 29



Support Sleeve
Type **FI-VH** Page 31



STAUFF Form EVO Sealing Ring
Type **FI-FD** Page 32



Union Nut
Type **FI-M** Page 33



37° Flared Tube Fitting Set
Type **FI-AB** Page 37

Spare Parts / Accessories



O-Ring
Type **O-RING** Page 239



Retaining Ring (Small)
Type **FI-KR** Page 247

J

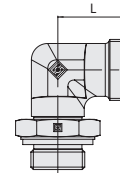
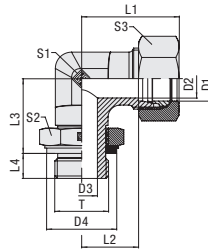
Adjustable Male Stud Elbow (90°) with Lock Nut
Type FI-WEE-...-M-OK • Series L / S



Metric Parallel Thread

O-Ring and Retaining Ring (Small)

Series	Tube OD mm	PN bar	Dimensions mm													Torque N-m	Weight kg ca. per 100	Ordering Codes ³
			Thread T	D2	D3	D4	L	L1 ¹	L2	L3	L4	S1	S2	S3	Thread T			
L	6	315	M 10 x 1	4	4	14,8	21	29	14	20	7	14	14	14	18	4,42	FI-WEE-06LM-OK-B-W3	
	8	315	M 12 x 1,5	6	4	17,8	23	31	16	23,5	10	14	17	17	35	5,14	FI-WEE-08LM-OK-B-W3	
	10	315	M 14 x 1,5	8	5	19,8	24	32	17	27	10	19	19	19	55	8,60	FI-WEE-10LM-OK-B-W3	
	12	315	M 16 x 1,5	10	7	22,8	26	34	19	27	10	19	22	22	80	10,44	FI-WEE-12LM-OK-B-W3	
	15	315	M 18 x 1,5	12	8	24,8	28	36	21	29	11	22	24	27	105	14,89	FI-WEE-15LM-OK-B-W3	
	18	250	M 22 x 1,5	15	12	27,8	31	40	23,5	36	12	27	27	32	125	23,93	FI-WEE-18LM-OK-B-W3	
	22	160	M 27 x 2	19	16	32,8	35	44	27,5	38	14	30	32	36	220	30,36	FI-WEE-22LM-OK-B-W3	
	28	160	M 33 x 2	24	20	40,8	38	47	30,5	47	14	36	41	41	370	51,70	FI-WEE-28LM-OK-B-W3	
	35	160	M 42 x 2	30	25	50,8	48	59	37,5	58	14	50	50	50	500	106,10	FI-WEE-35LM-OK-B-W3	
42	160	M 48 x 2	36	32	55,8	49	61	38	58,5	16	50	55	60	600	101,60	FI-WEE-42LM-OK-B-W3		
S	6	315	M 12 x 1,5	4	4	17,8	22	30	15	23,5	10	14	17	17	35	6,43	FI-WEE-06SM-OK-B-W3	
	8	315	M 14 x 1,5	5	5	19,8	24	32	17	27	10	19	19	19	55	9,06	FI-WEE-08SM-OK-B-W3	
	10	315	M 16 x 1,5	7	7	22,8	25	34	17,5	26	11	19	22	22	80	11,02	FI-WEE-10SM-OK-B-W3	
	12	315	M 18 x 1,5	8	8	24,8	29	38	21,5	28	12	22	24	24	105	15,90	FI-WEE-12SM-OK-B-W3	
	16	250	M 22 x 1,5	12	12	27,8	33	43	24,5	34	14	27	27	30	125	25,14	FI-WEE-16SM-OK-B-W3	
	20	250	M 27 x 2	16	16	32,8	38	49	27,5	36	16	30	32	36	220	38,45	FI-WEE-20SM-OK-B-W3	
	25	250	M 33 x 2	20	20	40,8	42	54	30	45	16	36	41	46	370	53,82	FI-WEE-25SM-OK-B-W3	
	30	160	M 42 x 2	25	25	50,8	49	62	35,5	55	17	50	50	50	500	110,10	FI-WEE-30SM-OK-B-W3	
	38	160	M 48 x 2	32	32	55,8	50	65	34	55,5	19	50	55	60	600	109,30	FI-WEE-38SM-OK-B-W3	

¹ Approximate dimension in assembled condition.

² Weight excluding cutting ring and union nut.

³ Standard scope of delivery: Fitting body only.

Port acc. to ISO 9974-1

Torque recommendations for Steel mating material.

Male threaded studs were designed for female threaded ports in components made of steel. For applications with components made of softer mating materials (e.g. Aluminium), the use of connectors with additionally rolled male threads is recommended.

Please contact STAUFF prior to the assembly for further information.

Standard seal material is NBR (Buna-N®).

Ordering Codes

***FI-WEE*-10*L*M*-OK*-B*-W3*-MS**

- * Adjustable Male Stud Elbow (90°) with Lock Nut **FI-WEE**
- * Outside Tube Diameter (in mm) **-10**
- * Series **L**
Light Series
S
Heavy Series
- * Thread Type **M**
Metric Parallel Thread

If required, please indicate special sizes, e.g. M26x1.5!

- * Seal Type **OK**
O-Ring and Retaining Ring (Small)
 - * Seal Material **B**
NBR (Buna-N®)
V
FKM (Viton®)
 - * Material Code **-W3**
Steel, zinc/nickel-plated
- Please contact STAUFF for alternative materials and surface finishings.

- * Assembling / Kitting **-**
Fitting body only
- MS**
Fitting body supplied with cutting ring and union nut
- MSV**
Fitting body supplied with soft-sealing cutting ring and union nut



Adjustable Male Stud Elbow (45°) with Lock Nut
Type FI-VEE-...-M-OK • Series L / S
Adjustable Male Stud Branch Tee with Lock Nut
Type FI-TEE-...-M-OK • Series L / S
Adjustable Male Stud Barrel Tee with Lock Nut
Type FI-LEE-...-M-OK • Series L / S
Type FI-VEE-...-M-OK
Metric Parallel Thread
O-Ring and Retaining Ring (Small)

Port acc. to ISO 9974-1

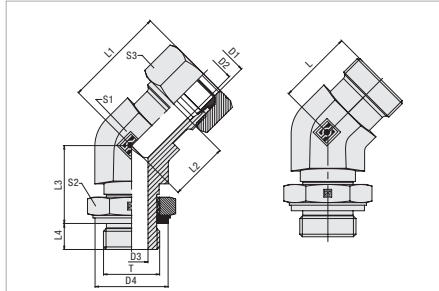

Dimensions L, L1, L2 and L3 deviating from the dimension table on the left.

Type FI-TEE-...-M-OK
Metric Parallel Thread
O-Ring and Retaining Ring (Small)

Port acc. to ISO 9974-1

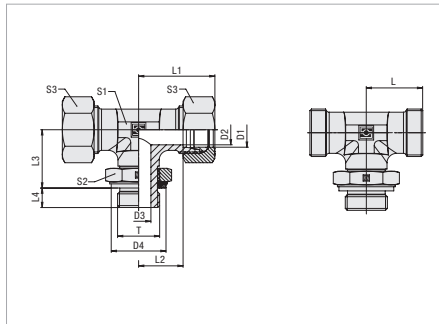
Type FI-LEE-...-M-OK
Metric Parallel Thread
O-Ring and Retaining Ring (Small)

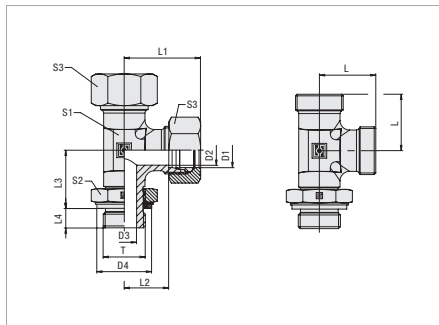

Port acc. to ISO 9974-1





Male threaded studs were designed for female threaded ports in components made of steel. For applications with components made of softer mating materials (e.g. Aluminium), the use of connectors with additionally rolled male threads is recommended.

Please contact STAUFF prior to the assembly for further information.

Connecting Parts

-  Cutting Ring
Type **FI-DS** Page 28
-  Soft-Sealing Cutting Ring
Type **FI-WDDS** Page 29
-  Support Sleeve
Type **FI-VH** Page 31

-  STAUFF Form EVO Sealing Ring
Type **FI-FD** Page 32
-  Union Nut
Type **FI-M** Page 33
-  37° Flared Tube Fitting Set
Type **FI-AB** Page 37

Spare Parts / Accessories

-  O-Ring
Type **O-RING** Page 239
-  Retaining Ring (Small)
Type **FI-KR** Page 247



Adjustable Male Stud Elbow (90°) with Lock Nut
Type FI-WEE-...-M-OR • Series L / S

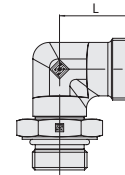
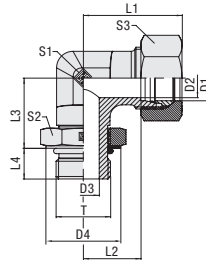

Metric Parallel Thread

O-Ring

Series	Tube OD mm	PN bar	Dimensions mm											Torque N-m	Weight kg ca. per 100	Ordering Codes ³	
			Thread T	D2	D3	D4	L	L1 ¹	L2	L3	L4	S1	S2				S3
L	6	315	M 10 x 1	4	4	14,5	21	29	14	20	7	14	14	14	15	5,16	FI-WEE-06LM-OR-B-W3
	8	315	M 12 x 1,5	6	4	17,5	23	31	16	23,5	10	14	17	17	25	5,44	FI-WEE-08LM-OR-B-W3
	10	315	M 14 x 1,5	8	5	19,5	24	32	17	27	10	19	19	19	35	9,00	FI-WEE-10LM-OR-B-W3
	12	315	M 16 x 1,5	10	7	22,5	26	34	19	27	10	19	22	22	40	10,23	FI-WEE-12LM-OR-B-W3
	15	315	M 18 x 1,5	12	8	24,5	28	36	21	29	11	22	24	27	45	14,59	FI-WEE-15LM-OR-B-W3
	18	250	M 22 x 1,5	15	12	27,5	31	40	23,5	36	12	27	27	32	60	23,09	FI-WEE-18LM-OR-B-W3
	22	160	M 27 x 2	19	16	32,5	35	44	27,5	38	14	30	32	36	100	39,11	FI-WEE-22LM-OR-B-W3
	28	160	M 33 x 2	24	20	41,5	38	47	30,5	47	14	36	41	41	160	61,54	FI-WEE-28LM-OR-B-W3
	35	160	M 42 x 2	30	25	50,5	48	59	37,5	58	14	50	50	50	210	131,90	FI-WEE-35LM-OR-B-W3
42	160	M 48 x 2	36	32	55,5	49	61	38	58,5	16	50	55	60	260	136,43	FI-WEE-42LM-OR-B-W3	
S	6	315	M 12 x 1,5	4	4	17,5	22	30	15	23,5	10	14	17	17	35	7,62	FI-WEE-06SM-OR-B-W3
	8	315	M 14 x 1,5	5	5	19,5	24	32	17	27	10	19	19	19	45	11,98	FI-WEE-08SM-OR-B-W3
	10	250	M 16 x 1,5	7	7	22,5	25	34	17,5	26	11	19	22	22	55	10,81	FI-WEE-10SM-OR-B-W3
	12	250	M 18 x 1,5	8	8	24,5	29	38	21,5	28	12	22	24	24	70	15,60	FI-WEE-12SM-OR-B-W3
	16	250	M 22 x 1,5	12	12	27,5	33	43	24,5	34	14	27	27	30	100	24,52	FI-WEE-16SM-OR-B-W3
	20	250	M 27 x 2	16	16	32,5	38	49	27,5	36	16	30	32	36	170	33,16	FI-WEE-20SM-OR-B-W3
	25	160	M 33 x 2	20	20	41,5	42	54	30	45	16	36	41	46	310	56,70	FI-WEE-25SM-OR-B-W3
	30	160	M 42 x 2	25	25	50,5	49	62	35,5	55	17	50	50	50	330	144,57	FI-WEE-30SM-OR-B-W3
38	160	M 48 x 2	32	32	55,5	50	65	34	55,5	19	50	55	60	420	152,80	FI-WEE-38SM-OR-B-W3	

¹ Approx.imate dimension in assembled condition.

² Weight excluding cutting ring and union nut.

³ Standard scope of delivery: Fitting body only.

Standard seal material is NBR (Buna-N®).

Male stud according to ISO 6149-2/-3

Port according to ISO 6149-1

Torque recommendations for Steel mating material.

Male threaded studs were designed for female threaded ports in components made of steel. For applications with components made of softer mating materials (e.g. Aluminium), the use of connectors with additionally rolled male threads is recommended.

Please contact STAUFF prior to the assembly for further information.

Ordering Codes

***FI-WEE*-10*L*M*-OR*-B*-W3*-MS**

- * Adjustable Male Stud Elbow (90°) with Lock Nut **FI-WEE**
- * Outside Tube Diameter (in mm) **-10**
- * Series **L**
Light Series
S
Heavy Series
- * Thread Type **M**
Metric Parallel Thread

If required, please indicate special sizes, e.g. M26x1.5!

- * Seal Type **O-Ring** **-OR**
 - * Seal Material **NBR (Buna-N®)** **-B**
FKM (Viton®) **-V**
 - * Material Code **Steel, zinc/nickel-plated** **-W3**
- Please contact STAUFF for alternative materials and surface finishings.

- * Assembling / Kitting Fitting body only **-**
- Fitting body supplied with cutting ring and union nut **-MS**
- Fitting body supplied with soft-sealing cutting ring and union nut **-MSV**



**Adjustable Male Stud Elbow (45°) with Lock Nut
Type FI-VEE-...-M-OR • Series L / S**
**Adjustable Male Stud Branch Tee with Lock Nut
Type FI-TEE-...-M-OR • Series L / S**
**Adjustable Male Stud Barrel Tee with Lock Nut
Type FI-LEE-...-M-OR • Series L / S**
Type FI-VEE-...-M-OR

Metric Parallel Thread
O-Ring

Male stud according to ISO 6149-2/-3
Port according to ISO 6149-1

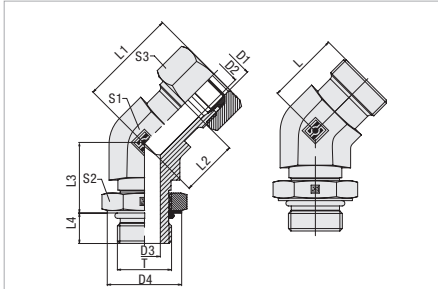

Dimensions L, L1, L2 and L3 deviating from the dimension table on the left.

Type FI-TEE-...-M-OR

Metric Parallel Thread
O-Ring

Male stud according to ISO 6149-2/-3
Port according to ISO 6149-1

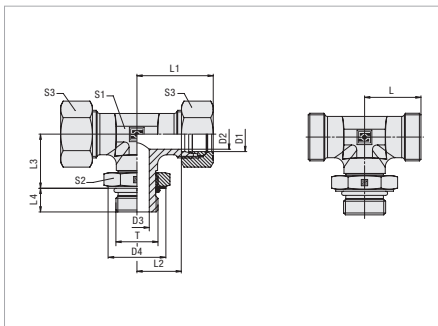
Type FI-LEE-...-M-OR

Metric Parallel Thread
O-Ring

Male stud according to ISO 6149-2/-3
Port according to ISO 6149-1

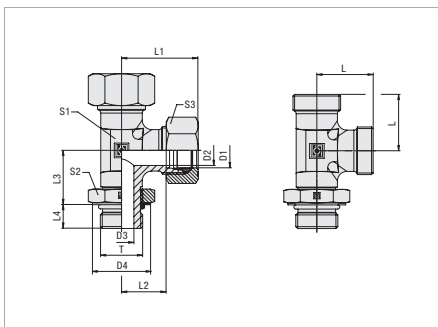

Male threaded studs were designed for female threaded ports in components made of steel. For applications with components made of softer mating materials (e.g. Aluminium), the use of connectors with additionally rolled male threads is recommended.

Please contact STAUFF prior to the assembly for further information.

Connecting Parts

Cutting Ring
Type **FI-DS** Page 28



Soft-Sealing Cutting Ring
Type **FI-WDDS** Page 29



Support Sleeve
Type **FI-VH** Page 31



STAUFF Form EVO Sealing Ring
Type **FI-FD** Page 32



Union Nut
Type **FI-M** Page 33



37° Flared Tube Fitting Set
Type **FI-AB** Page 37

Spare Parts / Accessories

O-Ring
Type **O-RING** Page 239



Adjustable Male Stud Elbow (90°) with Lock Nut
Type FI-WEE-...-U • Series L / S

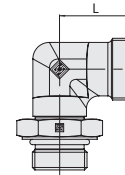
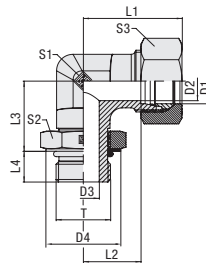

UN/UNF Thread

O-Ring

Series	Tube OD mm D1	PN bar	Dimensions mm													Torque N-m Thread T	Weight kg ca. per 100	Ordering Codes ³
			Thread T	D2	D3	D4	L	L1 ¹	L2	L3	L4	S1	S2	S3				
L	6	315	7/16-20 UNF	4	4,5	16,5	21	29	14	21	11	14	17	14	18	5,02	FI-WEE-06L7/16U-OR-B-W3	
	8	315	7/16-20 UNF	6	4,5	16,5	23	31	16	21	11	14	17	17	18	5,16	FI-WEE-08L7/16U-OR-B-W3	
	10	315	9/16-18 UNF	8	7,5	20,2	24	32	17	25	12	19	19	19	34	14,99	FI-WEE-10L9/16U-OR-B-W3	
	12	315	9/16-18 UNF	10	7,5	20,2	26	34	19	25,5	12	19	19	22	34	15,29	FI-WEE-12L9/16U-OR-B-W3	
	15	315	3/4-16 UNF	12	10	25,7	28	36	21	30	14	22	24	27	55	15,03	FI-WEE-15L3/4U-OR-B-W3	
	18	250	7/8-14 UNF	15	12,5	29,3	31	40	23,5	35	16	27	27	32	80	24,03	FI-WEE-18L7/8U-OR-B-W3	
	22	160	1 1/16-12 UN	19	15,5	36,7	35	44	27,5	39	18	30	36	36	100	35,96	FI-WEE-22L1-1/16U-OR-B-W3	
	28	160	1 5/16-12 UN	24	21,5	44	38	47	30,5	43	18	36	41	41	150	49,38	FI-WEE-28L1-5/16U-OR-B-W3	
	35	160	1 5/8-12 UN	30	27,5	55	48	59	37,5	50	18	50	50	50	290	106,22	FI-WEE-35L1-5/8U-OR-B-W3	
42	160	1 7/8-12 UN	36	33,5	62,3	49	61	37,89	52	18	50	55	60	325	101,73	FI-WEE-42L1-7/8U-OR-B-W3		
S	6	315	7/16-20 UNF	4	4,5	16,5	22	30	15	21	11	14	17	17	20	5,92	FI-WEE-06S7/16U-OR-B-W3	
	8	315	9/16-18 UNF	5	7,5	20,2	24	32	17	25	12	19	19	19	46	9,45	FI-WEE-08S9/16U-OR-B-W3	
	10	315	9/16-18 UNF	7	7,5	20,2	25	34	17,5	25,5	12	19	19	22	46	9,80	FI-WEE-10S9/16U-OR-B-W3	
	12	315	3/4-16 UNF	8	10	25,7	29	38	21,5	30	14	22	24	24	80	16,06	FI-WEE-12S3/4U-OR-B-W3	
	16	250	7/8-14 UNF	12	12,5	29,3	33	43	24,5	35	16	27	27	30	80	25,18	FI-WEE-16S7/8U-OR-B-W3	
	20	250	1 1/16-12 UN	16	15,5	36,7	38	49	27,5	39	18	30	36	36	185	38,53	FI-WEE-20S1-1/16U-OR-B-W3	
	25	160	1 1/16-12 UN	20	15,5	36,7	42	54	30	43	18	36	36	46	185	53,90	FI-WEE-25S1-1/16U-OR-B-W3	
	30	160	1 5/8-12 UN	25	27,5	55	49	62	35,5	50	18	50	50	50	340	110,22	FI-WEE-30S1-5/8U-OR-B-W3	
	38	160	1 7/8-12 UN	32	33,5	62,3	50	65	33,9	52	18	50	55	60	415	109,43	FI-WEE-38S1-7/8U-OR-B-W3	

¹ Approximate dimension in assembled condition.

² Weight excluding cutting ring and union nut.

³ Standard scope of delivery: Fitting body only.

Standard seal material is NBR (Buna-N®).

Male stud acc. to ISO 11926-2/-3

Port acc. to ISO 11926-1

Torque recommendations for Steel mating material.

Male threaded studs were designed for female threaded ports in components made of steel. For applications with components made of softer mating materials (e.g. Aluminium), the use of connectors with additionally rolled male threads is recommended.

Please contact STAUFF prior to the assembly for further information.

Ordering Codes

***FI-WEE*-10*L*9/16*U*-OR*-B*-W3*-MS**

* Adjustable Male Stud Elbow (90°) with Lock Nut **FI-WEE**

* Outside Tube Diameter (in mm) **-10**

* Series Light Series **L**
 Heavy Series **S**

* Thread Size acc. to dimension table **9/16**

Please always indicate thread sizes, e.g. 9/16!

* Thread Type UN/UNF Thread with O-Ring **U**

* Seal Material NBR (Buna-N®) **-B**
 FKM (Viton®) **-V**

* Material Code Steel, zinc/nickel-plated **-W3**

Please contact STAUFF for alternative materials and surface finishings.

* Assembling / Kitting Fitting body only **-**

Fitting body supplied with cutting ring and union nut **-MS**

Fitting body supplied with soft-sealing cutting ring and union nut **-MSV**

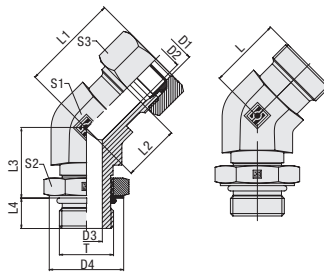

**Adjustable Male Stud Elbow (45°) with Lock Nut
Type FI-VEE-...-U • Series L / S**
**Adjustable Male Stud Branch Tee with Lock Nut
Type FI-TEE-...-U • Series L / S**
**Adjustable Male Stud Barrel Tee with Lock Nut
Type FI-LEE-...-U • Series L / S**
Type FI-VEE-...-U
**UN/UNF Thread
O-Ring**

 Male stud according to ISO 6149-2/-3
 Port according to ISO 6149-1

Dimensions L, L1, L2 and L3 deviating from the dimension table on the left.

Type FI-TEE-...-U
**UN/UNF Thread
O-Ring**

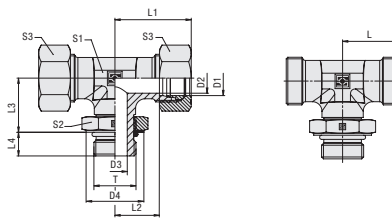
 Male stud according to ISO 6149-2/-3
 Port according to ISO 6149-1

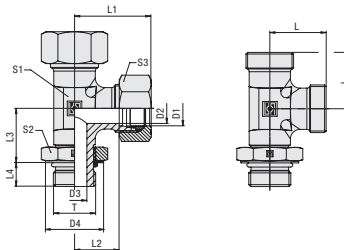
Type FI-LEE-...-U
**UN/UNF Thread
O-Ring**

 Male stud according to ISO 6149-2/-3
 Port according to ISO 6149-1

Male threaded studs were designed for female threaded ports in components made of steel. For applications with components made of softer mating materials (e.g. Aluminium), the use of connectors with additionally rolled male threads is recommended.

Please contact STAUFF prior to the assembly for further information.

Connecting Parts

 Cutting Ring
 Type **FI-DS** Page 28

 Soft-Sealing Cutting Ring
 Type **FI-WDDS** Page 29

 Support Sleeve
 Type **FI-VH** Page 31

 STAUFF Form EVO Sealing Ring
 Type **FI-FD** Page 32

 Union Nut
 Type **FI-M** Page 33

 37° Flared Tube Fitting Set
 Type **FI-AB** Page 37

Spare Parts / Accessories

 O-Ring
 Type **O-RING** Page 239

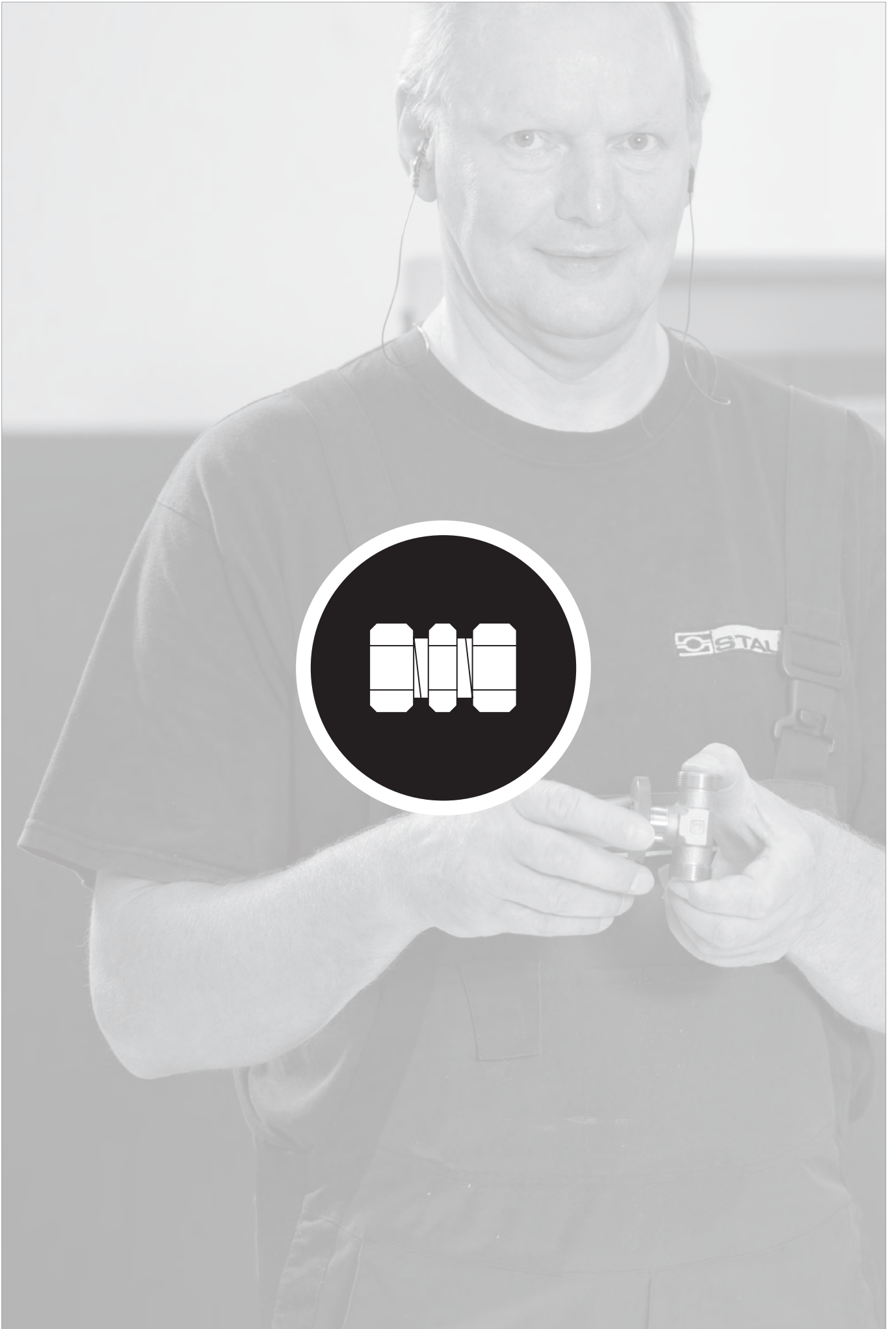
Banjo Elbow (Medium-Pressure Version)
 FI-RSWND

182-185

**Whitworth Parallel Pipe Thread (BSPP) /
External Metallic Sealing Ring**
 FI-RSWND-...-R-DK

182

**Metric Parallel Thread /
External Metallic Sealing Ring**
 FI-RSWND-...-M-DK

183

**Whitworth Parallel Pipe Thread (BSPP) /
Retaining Ring with Captive Seal**
 FI-RSWND-...-R-WD

184

**Metric Parallel Thread /
Retaining Ring with Captive Seal**
 FI-RSWND-...-M-WD

185

Banjo Elbow (High-Pressure Version)
 FI-RSW

186-189

**Whitworth Parallel Pipe Thread (BSPP) /
External Metallic Sealing Ring**
 FI-RSW-...-R-DK

186

**Metric Parallel Thread /
External Metallic Sealing Ring**
 FI-RSW-...-M-DK

187

**Whitworth Parallel Pipe Thread (BSPP) /
Retaining Ring with Captive Seal**
 FI-RSW-...-R-WD

188

**Metric Parallel Thread /
Retaining Ring with Captive Seal**
 FI-RSW-...-M-WD

189

Banjo Tee (High-Pressure Version)
 FI-RST

190-193

**Whitworth Parallel Pipe Thread (BSPP) /
External Metallic Sealing Ring**
 FI-RST-...-R-DK

190

**Metric Parallel Thread /
External Metallic Sealing Ring**
 FI-RST-...-M-DK

191

**Whitworth Parallel Pipe Thread (BSPP) /
Retaining Ring with Captive Seal**
 FI-RST-...-R-WD

192

**Metric Parallel Thread /
Retaining Ring with Captive Seal**
 FI-RST-...-M-WD

193

K

Banjo Elbow (Medium-Pressure Version)
Type FI-RSWND-...-R-DK • Series LL / L / S

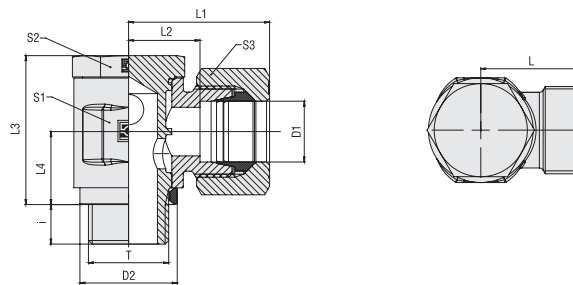

Whitworth Parallel Pipe Thread (BSPP)

External Metallic Sealing Ring

Ordering Codes

***FI-RSWND*-10*L*R*-DK*-W3*-MS**

* Banjo Elbow (Medium-Pressure Version) **FI-RSWND**

* Outside Tube Diameter D1 (in mm) **-10**

* Series Extra-Light Series **LL**
 Light Series **L**
 Heavy Series **S**

* Thread Type Whitworth Parallel Pipe Thread (BSPP) **R**

If required, please indicate special sizes, e.g. R1/8!

* Seal Type External Metallic Sealing Ring **-DK**

* Material Code Steel, zinc/nickel-plated **-W3**

Please contact STAUFF for alternative materials and surface finishings.

* Assembling / Kitting Fitting body only **—**

Fitting body supplied with cutting ring and union nut **-MS**

Fitting body supplied with soft-sealing cutting ring and union nut **-MSV**

Series	Tube OD mm D1	PB bar	Dimensions mm											Weight kg ca. per 100	Ordering Codes ³
			Thread	T	D2	i	L	L1 ¹	L2	L3	L4	S1	S2		
LL	4	100	G 1/8	13	6	15,5	21	11,5	21	10	14	14	10	2,85	FI-RSWND-04LLR-DK-W3
	6	100	G 1/8	13	6	15,5	21	10	21	10	14	14	12	2,85	FI-RSWND-06LLR-DK-W3
	8	100	G 1/8	13	6	16,5	23	11	21	10	14	14	14	2,93	FI-RSWND-08LLR-DK-W3
L	6	250	G 1/8	13	6	18,5	25	11,5	21	10	14	14	14	3,15	FI-RSWND-06LR-DK-W3
	8	250	G 1/4	17,7	10	20	26	13	26	12	17	19	17	5,85	FI-RSWND-08LR-DK-W3
	10	250	G 1/4	17,7	9	22	30	15	27	13	19	19	19	6,95	FI-RSWND-10LR-DK-W3
	10	160	G 3/8	22	9	23	31	16	32	15	22	22	19	10,11	FI-RSWND-10LR3/8-DK-W3
	12	160	G 1/4	17,7	9	23	30	16	28	13	22	19	22	8,23	FI-RSWND-12LR1/4-DK-W3
	12	250	G 3/8	22	9	23	31	16	32	15	22	22	22	6,77	FI-RSWND-12LR-DK-W3
	12	160	G 1/2	26	11	26,5	34	19,5	37,5	18	27	27	22	16,42	FI-RSWND-12LR1/2-DK-W3
	15	160	G 1/2	26	11	26,5	35	19,5	37,5	18	27	27	27	17,36	FI-RSWND-15LR-DK-W3
	18	160	G 1/2	26	11	27	36	19,5	44,5	21,5	30	27	32	21,47	FI-RSWND-18LR-DK-W3
	22	160	G 3/4	32	13	32	41	24,5	49	24	36	32	36	30,63	FI-RSWND-22LR-DK-W3
S	6	250	G 1/4	17,7	10	21,5	29	14,5	26	12	17	19	17	6,23	FI-RSWND-06SR-DK-W3
	8	250	G 1/4	17,7	9	23	29	16	27	13	19	19	19	7,47	FI-RSWND-08SR-DK-W3
	10	250	G 3/8	22	9	23,5	32	16	32	15	22	22	22	10,92	FI-RSWND-10SR-DK-W3
	12	250	G 3/8	22	9	26	34	18,5	37	18	24	24	24	14,87	FI-RSWND-12SR-DK-W3
	14	160	G 1/2	26	11	28,5	39	20,5	37,5	18	27	27	27	18,58	FI-RSWND-14SR-DK-W3
	16	160	G 1/2	26	11	30	40	21,5	44,5	21,5	30	27	30	22,48	FI-RSWND-16SR-DK-W3
	20	160	G 3/4	32	13	34	45	23,5	49	24	36	32	36	32,20	FI-RSWND-20SR-DK-W3

¹ Approximate dimension in assembled condition.

² Weight excluding cutting ring and union nut.

³ Standard scope of delivery: Fitting body only.

Port acc. to DIN 3852-2 (Form X) / ISO 1179-1

Male threaded studs were designed for female threaded ports in components made of steel. For applications with components made of softer mating materials (e.g. Aluminium), the use of connectors with additionally rolled male threads is recommended.

Please contact STAUFF prior to the assembly for further information.

Connecting Parts

-  Cutting Ring
Type **FI-DS** Page 28
-  Soft-Sealing Cutting Ring
Type **FI-WDDS** Page 29
-  Support Sleeve
Type **FI-VH** Page 31
-  STAUFF Form EVO Sealing Ring
Type **FI-FD** Page 32
-  Union Nut
Type **FI-M** Page 33
-  37° Flared Tube Fitting Set
Type **FI-AB** Page 37

Spare Parts / Accessories

-  External Metallic Sealing Ring
Type **FI-DKR** Page 244



Banjo Elbow (Medium-Pressure Version) Type FI-RSWND-...-M-DK ■ Series LL / L / S

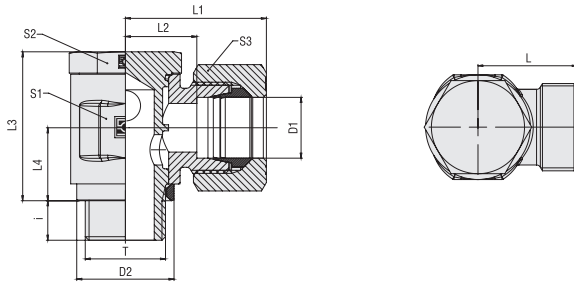

External Metallic Sealing Ring

Metric Parallel Thread

Series	Tube OD mm	PB bar	Dimensions mm													Weight kg ca. per 100	Ordering Codes ³
			Thread	T	D2	i	L	L1 ¹	L2	L3	L4	S1	S2	S3			
LL	4	100	M 8 x 1	10,8	6	15,5	21	11,5	17	8	14	12	10	2,66	FI-RSWND-04LLM-DK-W3		
	6	100	M 10 x 1	13	6	15,5	21	10	21	10	14	14	12	2,86	FI-RSWND-06LLM-DK-W3		
	8	100	M 10 x 1	13	6	16,5	23	11	21	10	14	14	14	2,94	FI-RSWND-08LLM-DK-W3		
L	6	250	M 10 x 1	13	6	18,5	26	11,5	21	10	14	14	14	3,16	FI-RSWND-06LM-DK-W3		
	8	250	M 12 x 1,5	17,8	9	20	28	13	25	12	17	17	17	5,02	FI-RSWND-08LM-DK-W3		
	10	250	M 14 x 1,5	17,8	9	22	30	15	27	13	19	19	19	7,02	FI-RSWND-10LM-DK-W3		
	12	250	M 16 x 1,5	21,5	9	23	31	16	32	15	22	22	22	6,63	FI-RSWND-12LM-DK-W3		
	12	160	M 18 x 1,5	23	9	25	33	18	37	18,5	24	24	22	12,70	FI-RSWND-12LM18x1,5-DK-W3		
	15	160	M 18 x 1,5	23	9	25	33	18	37	18	24	24	27	13,44	FI-RSWND-15LM-DK-W3		
	18	160	M 22 x 1,5	27	11	27	36	19,5	44,5	21,5	30	27	32	22,82	FI-RSWND-18LM-DK-W3		
	22	160	M 26 x 1,5	31	13	32	41	24,5	49	24	36	32	36	30,46	FI-RSWND-22LM-DK-W3		
	22	250	M 12 x 1,5	17,8	9	21,5	29	14,5	25	12	17	17	17	5,39	FI-RSWND-06SM-DK-W3		
S	8	250	M 14 x 1,5	17,8	9	23	31	16	27	13	19	19	19	7,54	FI-RSWND-08SM-DK-W3		
	10	250	M 16 x 1,5	21,5	9	23,5	32,5	16	32	15	22	22	22	10,78	FI-RSWND-10SM-DK-W3		
	12	250	M 18 x 1,5	23	9	25	34	17,5	37	18	24	24	24	13,70	FI-RSWND-12SM-DK-W3		
	14	160	M 20 x 1,5	26	11	28,5	38,5	20,5	37	18	27	27	27	17,94	FI-RSWND-14SM-DK-W3		
	16	160	M 22 x 1,5	27	11	30	40	21,5	44,5	21,5	30	27	30	23,83	FI-RSWND-16SM-DK-W3		
	20	160	M 27 x 2	32	13	34	45	23,5	49	24	36	32	36	33,34	FI-RSWND-20SM-DK-W3		

¹ Approximate dimension in assembled condition.

² Weight excluding cutting ring and union nut.

³ Standard scope of delivery: Fitting body only.

Port acc. to DIN 3852-1 (Form X) / ISO 9974-1

Male threaded studs were designed for female threaded ports in components made of steel. For applications with components made of softer mating materials (e.g. Aluminium), the use of connectors with additionally rolled male threads is recommended.

Please contact STAUFF prior to the assembly for further information.

Ordering Codes

***FI-RSWND*-10*L*M*-DK*-W3*-MS**

* Banjo Elbow (Medium-Pressure Version) **FI-RSWND**

* Outside Tube Diameter D1 (in mm) **-10**

* Series **LL**
Light Series **L**
Heavy Series **S**

* Thread Type **M**
Metric Parallel Thread

If required, please indicate special sizes, e.g. M12x1.5!

* Seal Type **-DK**
External Metallic Sealing Ring

* Material Code **-W3**
Steel, zinc/nickel-plated

Please contact STAUFF for alternative materials and surface finishings.

* Assembling / Kitting **—**
Fitting body only

Fitting body supplied with cutting ring and union nut **-MS**

Fitting body supplied with soft-sealing cutting ring and union nut **-MSV**

Connecting Parts

	Cutting Ring Type FI-DS	Page 28
	Soft-Sealing Cutting Ring Type FI-WDDS	Page 29
	Support Sleeve Type FI-VH	Page 31
	STAUFF Form EVO Sealing Ring Type FI-FD	Page 32
	Union Nut Type FI-M	Page 33
	37° Flared Tube Fitting Set Type FI-AB	Page 37

Spare Parts / Accessories

	External Metallic Sealing Ring Type FI-DKR	Page 244
--	--	----------



Banjo Elbow (Medium-Pressure Version) Type FI-RSND-...-R-WD ▪ Series LL / L / S

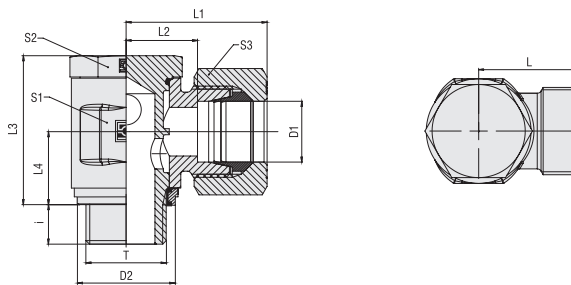

Whitworth Parallel Pipe Thread (BSPP)

Retaining Ring with Captive Seal

Ordering Codes

- *FI-RSND*-10*L*R*-WD*-B*-W3*-MS**
- * Banjo Elbow (Medium-Pressure Version) FI-RSND**
- * Outside Tube Diameter D1 (in mm) -10**
- * Series**
 - Extra-Light Series **LL**
 - Light Series **L**
 - Heavy Series **S**
- * Thread Type**
 - Whitworth Parallel Pipe Thread (BSPP) **R**
- If required, please indicate special sizes, e.g. R1/8!
- * Seal Type** Retaining Ring with Captive Seal **-WD**
- * Seal Material**
 - NBR (Buna-N®) **-B**
 - FKM (Viton®) **-V**
- * Material Code** Steel, zinc/nickel-plated **-W3**
- Please contact STAUFF for alternative materials and surface finishings.
- * Assembling / Kitting**
 - Fitting body only **—**
 - Fitting body supplied with cutting ring and union nut **-MS**
 - Fitting body supplied with soft-sealing cutting ring and union nut **-MSV**

Series	Tube OD mm D1	PB bar	Dimensions mm											Weight kg ca. per 100	Ordering Codes ³
			Thread	T	D2	i	L	L1 ¹	L2	L3	L4	S1	S2		
LL	6	100	G 1/8	14,9	6	15,5	24	10	21	10	14	14	14	2,70	FI-RSND-06LLR-WD-B-W3
	8	100	G 1/8	14,9	6	16,5	26	11	21	10	14	14	14	2,80	FI-RSND-08LLR-WD-B-W3
L	6	250	G 1/8	14,9	6	18,5	25	11,5	21	10	14	14	14	3,07	FI-RSND-06LR-WD-B-W3
	8	250	G 1/4	18,8	10	20	26	13	26	12	17	19	17	5,97	FI-RSND-08LR-WD-B-W3
	10	250	G 1/4	18,8	9	22	30	15	27	13	19	19	19	7,60	FI-RSND-10LR-WD-B-W3
	10	250	G 3/8	22,8	8	23	31	16	33	15	22	22	19	9,95	FI-RSND-10LR3/8-WD-B-W3
	12	250	G 1/4	18,8	9,5	16	30	16	28,2	13	22	19	22	8,27	FI-RSND-12LR1/4-WD-B-W3
	12	250	G 3/8	22,8	9	23	31	16	32	15	22	22	22	10,45	FI-RSND-12LR-WD-B-W3
	15	160	G 1/2	27,9	11	26,5	35	19,5	37,5	18	27	27	27	18,00	FI-RSND-15LR-WD-B-W3
	18	250	G 1/2	27,9	11	27	36	19,5	44,5	21,5	30	27	32	22,31	FI-RSND-18LR-WD-B-W3
	22	160	G 3/4	32,9	13	32	41	24,5	49	24	36	32	36	31,05	FI-RSND-22LR-WD-B-W3
	22	250	G 1/4	18,8	10	21,5	29	14,5	26	12	17	19	17	6,34	FI-RSND-06SR-WD-B-W3
S	8	250	G 1/4	18,8	9	23	29	16	27	13	19	19	19	7,60	FI-RSND-08SR-WD-B-W3
	10	250	G 3/8	22,8	9	23,5	32	16	32	15	22	22	22	10,89	FI-RSND-10SR-WD-B-W3
	12	250	G 3/8	22,8	9	26	34	18,5	37	18	24	24	24	14,51	FI-RSND-12SR-WD-B-W3
	14	160	G 1/2	27,9	11	28,5	39	20,5	37,5	18	27	27	27	18,77	FI-RSND-14SR-WD-B-W3
	16	160	G 1/2	27,9	11	30	40	21,5	44,5	21,5	30	27	30	23,32	FI-RSND-16SR-WD-B-W3
	20	160	G 3/4	32,9	13	34	45	23,5	49	24	36	32	36	32,63	FI-RSND-20SR-WD-B-W3

¹ Approximate dimension in assembled condition.

² Weight excluding cutting ring and union nut.

³ Standard scope of delivery: Fitting body only.

Standard seal material is NBR (Buna-N®).

Port acc. to DIN 3852-2 (Form X) / ISO 1179-1



Male threaded studs were designed for female threaded ports in components made of steel. For applications with components made of softer mating materials (e.g. Aluminium), the use of connectors with additionally rolled male threads is recommended.

Please contact STAUFF prior to the assembly for further information.

Connecting Parts

-  Cutting Ring
Type **FI-DS** Page 28
-  Soft-Sealing Cutting Ring
Type **FI-WDDS** Page 29
-  Support Sleeve
Type **FI-VH** Page 31
-  STAUFF Form EVO Sealing Ring
Type **FI-FD** Page 32
-  Union Nut
Type **FI-M** Page 33
-  37° Flared Tube Fitting Set
Type **FI-AB** Page 37

Spare Parts / Accessories

-  Retaining Ring with Captive Seal
Type **FI-DIR** Page 245
-  O-Ring
Type **O-RING** Page 239

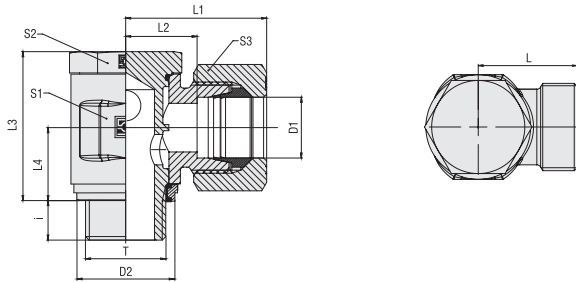

Banjo Elbow (Medium-Pressure Version) Type FI-RSWND-...-M-WD ■ Series LL / L / S

Retaining Ring with Captive Seal
Metric Parallel Thread

Series	Tube OD mm	PB bar	Dimensions mm													Weight kg ca. per 100	Ordering Codes ³
			Thread	T	D2	i	L	L1 ¹	L2	L3	L4	S1	S2	S3			
LL	6	100	M 10 x 1	14,9	6	15,5	24	10	21	10	14	14	14	2,70	FI-RSWND-06LLM-WD-B-W3		
	8	100	M 10 x 1	14,9	6	16,5	26	11	21	10	14	14	14	2,80	FI-RSWND-08LLM-WD-B-W3		
L	6	250	M 10 x 1	14,9	6	18,5	26	11,5	21	10	14	14	14	3,10	FI-RSWND-06LM-WD-B-W3		
	8	250	M 12 x 1,5	17,8	9	20	28	13	25	12	17	17	17	5,20	FI-RSWND-08LM-WD-B-W3		
	10	250	M 14 x 1,5	19,9	9	22	30	15	27	13	19	19	19	7,31	FI-RSWND-10LM-WD-B-W3		
	12	250	M 16 x 1,5	22,8	9	23	31	16	32	15	22	22	22	10,27	FI-RSWND-12LM-WD-B-W3		
	15	250	M 18 x 1,5	24,9	9	25	33	18	37	19	24	24	24	12,66	FI-RSWND-15LM-WD-B-W3		
	18	250	M 22 x 1,5	27,9	11	27	36	19,5	44,5	21,5	30	27	32	22,65	FI-RSWND-18LM-WD-B-W3		
	22	160	M 26 x 1,5	32,5	13	32	41	24,5	49	24	36	32	36	30,84	FI-RSWND-22LM-WD-B-W3		
S	6	250	M 12 x 1,5	17,8	9	21,5	29	14,5	25	12	17	17	17	5,57	FI-RSWND-06SM-WD-B-W3		
	8	250	M 14 x 1,5	19,9	9	23	31	16	27	13	19	19	19	7,82	FI-RSWND-08SM-WD-B-W3		
	10	250	M 16 x 1,5	22,8	9	23,5	32,5	16	32	15	22	22	22	10,71	FI-RSWND-10SM-WD-B-W3		
	12	250	M 18 x 1,5	24,9	9	25	34	17,5	37	18	24	24	24	14,12	FI-RSWND-12SM-WD-B-W3		
	16	160	M 22 x 1,5	27,9	11	30	40	21,5	44,5	21,5	30	27	30	23,66	FI-RSWND-16SM-WD-B-W3		
	20	160	M 27 x 2	32,9	13	34	45	23,5	49	24	36	32	36	33,01	FI-RSWND-20SM-WD-B-W3		

¹ Approx.imate dimension in assembled condition.

² Weight excluding cutting ring and union nut.

³ Standard scope of delivery: Fitting body only.

Standard seal material is NBR (Buna-N®).

Port acc. to DIN 3852-1 (Form X) / ISO 9974-1

Male threaded studs were designed for female threaded ports in components made of steel. For applications with components made of softer mating materials (e.g. Aluminium), the use of connectors with additionally rolled male threads is recommended.

Please contact STAUFF prior to the assembly for further information.

Ordering Codes
***FI-RSWND*-10*L*M*-WD*-B*-W3*-MS**

 * Banjo Elbow (Medium-Pressure Version) **FI-RSWND**

 * Outside Tube Diameter D1 (in mm) **-10**

 * Series **LL**
 Extra-Light Series
L
 Light Series
S
 Heavy Series

 * Thread Type **M**
 Metric Parallel Thread

If required, please indicate special sizes, e.g. M12x1.5!

 * Seal Type **-WD**
 Retaining Ring with Captive Seal

 * Seal Material **-B**
 NBR (Buna-N®)
-V
 FKM (Viton®)

 * Material Code **-W3**
 Steel, zinc/nickel-plated

Please contact STAUFF for alternative materials and surface finishings.

 * Assembling / Kitting **—**
 Fitting body only

-MS
 Fitting body supplied with cutting ring and union nut

-MSV
 Fitting body supplied with soft-sealing cutting ring and union nut

Connecting Parts

	Cutting Ring Type FI-DS	Page 28
	Soft-Sealing Cutting Ring Type FI-WDDS	Page 29
	Support Sleeve Type FI-VH	Page 31
	STAUFF Form EVO Sealing Ring Type FI-FD	Page 32
	Union Nut Type FI-M	Page 33
	37° Flared Tube Fitting Set Type FI-AB	Page 37

Spare Parts / Accessories

	Retaining Ring with Captive Seal Type FI-DIR	Page 245
	O-Ring Type O-RING	Page 239



Banjo Elbow (High-Pressure Version)
Type FI-RSW-...-R-DK ■ Series L / S

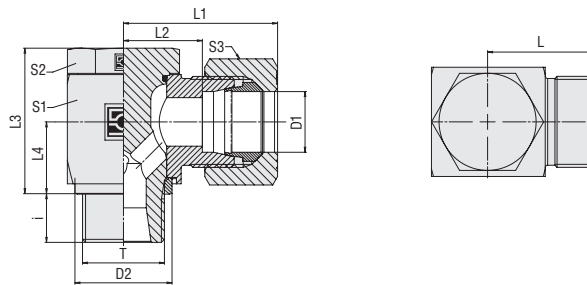

Whitworth Parallel Pipe Thread (BSPP)

External Metallic Sealing Ring

Ordering Codes

***FI-RSW*-10*L*R*-DK*-B*-W3*-MS**

* Banjo Elbow (High-Pressure Version) **FI-RSW**

* Outside Tube Diameter D1 (in mm) **-10**

* Series Light Series **L**
 Heavy Series **S**

* Thread Type Whitworth Parallel Pipe Thread (BSPP) **R**

If required, please indicate special sizes, e.g. R1/8!

* Seal Type External Metallic Sealing Ring **-DK**

* Seal Material NBR (Buna-N®) **-B**
 FKM (Viton®) **-V**

* Material Code Steel, zinc/nickel-plated **-W3**

Please contact STAUFF for alternative materials and surface finishings.

* Assembling / Kitting Fitting body only **—**

Fitting body supplied with cutting ring and union nut **-MS**

Fitting body supplied with soft-sealing cutting ring and union nut **-MSV**

Series	Tube OD mm D1	PB bar	Dimensions mm											Weight kg ca. per 100	Ordering Codes ³
			Thread	T	D2	i	L	L1 ¹	L2	L3	L4	S1	S2		
L	6	500	G 1/8	13	8	20	28	13	21	10,5	14	14	14	3,61	FI-RSW-06LR-DK-B-W3
	6	500	G 1/4	17,7	10	22	30,5	15	27,5	13,3	19	19	14	7,86	FI-RSW-06LR1/4-DK-B-W3
	8	500	G 1/4	17,8	10	21	29	14	27	13,5	19	19	17	7,93	FI-RSW-08LR-DK-B-W3
	10	500	G 1/4	17,8	10	22	30	15	27	13,5	19	19	19	8,15	FI-RSW-10LR-DK-B-W3
	12	400	G 1/4	17,7	10	22	35	15	30,5	15,3	27	22	19	9,92	FI-RSW-12LR1/4-DK-B-W3
	12	400	G 3/8	22	12	24,5	32,5	17,5	32,5	16	24	22	22	13,75	FI-RSW-12LR-DK-B-W3
	15	400	G 1/2	26	14	27	35	21	43	19,5	30	27	27	25,80	FI-RSW-15LR-DK-B-W3
	18	400	G 1/2	26	12	28	37	20,5	43	21,5	30	27	32	26,56	FI-RSW-18LR-DK-B-W3
	22	250	G 3/4	32	16	34,5	43,5	27	48	24	36	32	36	43,25	FI-RSW-22LR-DK-B-W3
	28	250	G 1	39	18	39	48	31,5	59	30,5	46	41	41	83,60	FI-RSW-28LR-DK-B-W3
	35	250	G 1 1/4	49	20	46	57	35,5	70	35,5	55	50	50	140,80	FI-RSW-35LR-DK-B-W3
	42	250	G 1 1/2	55	22	51	63	40	80	40,5	65	55	60	211,80	FI-RSW-42LR-DK-B-W3
S	6	500	G 1/4	17,8	10	23	31	16	27	13,5	19	19	17	8,36	FI-RSW-06SR-DK-B-W3
	8	500	G 1/4	17,8	10	23	31	16	27	13,5	19	19	19	8,62	FI-RSW-08SR-DK-B-W3
	10	500	G 3/8	22	10	25,5	34,5	18	32,5	16	24	22	22	14,57	FI-RSW-10SR-DK-B-W3
	12	400	G 3/8	22	10	27	36	18	32,5	16	24	22	24	14,59	FI-RSW-12SR-DK-B-W3
	14	400	G 1/2	26	14	30	40	22	41	19,5	30	27	27	26,55	FI-RSW-14SR-DK-B-W3
	16	400	G 1/2	26	12	30	40	21,5	43	21,5	30	27	30	26,86	FI-RSW-16SR-DK-B-W3
	20	315	G 3/4	32	16	36,5	47,5	26	48	24	36	32	36	44,88	FI-RSW-20SR-DK-B-W3
	25	250	G 1	39	18	43	55	31	59	30,5	46	41	46	87,00	FI-RSW-25SR-DK-B-W3
	30	250	G 1 1/4	49	20	50	63	36,5	70	35,5	55	50	50	145,00	FI-RSW-30SR-DK-B-W3
	38	250	G 1 1/2	55	22	57	72	41	80	40,5	65	55	60	223,40	FI-RSW-38SR-DK-B-W3

¹ Approximate dimension in assembled condition.

² Weight excluding cutting ring and union nut.

³ Standard scope of delivery: Fitting body only.

Port acc. to DIN 3852-2 (Form X) / ISO 1179-1

Male threaded studs were designed for female threaded ports in components made of steel. For applications with components made of softer mating materials (e.g. Aluminium), the use of connectors with additionally rolled male threads is recommended.

Please contact STAUFF prior to the assembly for further information.

Standard seal material is NBR (Buna-N®).



For use with aggressive media and/or at elevated temperatures, please remove the o-ring from the groove located on the banjo bolt prior to installation.

Connecting Parts

-  Cutting Ring
Type **FI-DS** Page 28
-  Soft-Sealing Cutting Ring
Type **FI-WDDS** Page 29
-  Support Sleeve
Type **FI-VH** Page 31
-  STAUFF Form EVO Sealing Ring
Type **FI-FD** Page 32
-  Union Nut
Type **FI-M** Page 33
-  37° Flared Tube Fitting Set
Type **FI-AB** Page 37

Spare Parts / Accessories

-  External Metallic Sealing Ring
Type **FI-DKR** Page 245
-  O-Ring
Type **O-RING** Page 239

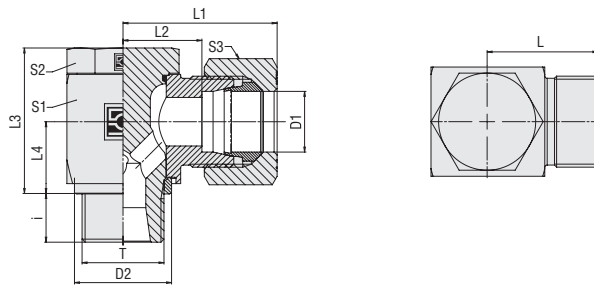

**Banjo Elbow (High-Pressure Version)
Type FI-RSW-...-M-DK ■ Series L / S**

External Metallic Sealing Ring
Metric Parallel Thread

Series	Tube OD mm	PB bar	Dimensions mm											Weight kg ca. per 100	Ordering Codes ³	
			Thread	T	D2	i	L	L1 ¹	L2	L3	L4	S1	S2			S3
L	6	500	M10x1	13	8	20	28	13	21	10	14	14	14	3,66	FI-RSW-06LM-DK-B-W3	
	8	500	M12x1,5	17,8	10	21	29	14	27	13,5	19	19	17	7,70	FI-RSW-08LM-DK-B-W3	
	10	500	M14x1,5	17,8	10	22	30	15	27	13,5	19	19	19	8,21	FI-RSW-10LM-DK-B-W3	
	12	400	M16x1,5	21	10	24,5	32,5	17,5	32,5	16	24	22	22	13,72	FI-RSW-12LM-DK-B-W3	
	12	315	M18x1,5	17,7	10	22	35	15	30,5	15,3	27	22	19	18,48	FI-RSW-12LM18x1,5-DK-B-W3	
	15	400	M18x1,5	23	10	27	35	20	37	18,5	27	24	27	17,73	FI-RSW-15LM-DK-B-W3	
	18	400	M22x1,5	27	12	28	37	20,5	43	21,5	30	27	32	27,01	FI-RSW-18LM-DK-B-W3	
	22	250	M26x1,5	31	16	34,5	43,5	27	48	24	36	32	36	42,27	FI-RSW-22LM-DK-B-W3	
	28	250	M33x2	39	18	39	48	31,5	59	30,5	46	41	41	83,30	FI-RSW-28LM-DK-B-W3	
	35	250	M42x2	49	20	46	57	35,5	70	35,5	55	50	50	146,51	FI-RSW-35LM-DK-B-W3	
	42	250	M48x2	55	22	51	63	40	80	40,5	65	55	60	226,97	FI-RSW-42LM-DK-B-W3	
	S	6	500	M12x1,5	17,8	10	23	31	16	27	13,5	19	19	17	10,09	FI-RSW-06SM-DK-B-W3
		8	500	M14x1,5	17,8	10	23	31	16	27	13,5	19	19	19	8,69	FI-RSW-08SM-DK-B-W3
		10	500	M16x1,5	21	10	25,5	34,5	18	32,5	16	24	22	22	14,46	FI-RSW-10SM-DK-B-W3
12		400	M18x1,5	23	10	27	36	19,5	37	18,5	27	24	24	19,33	FI-RSW-12SM-DK-B-W3	
14		400	M20x1,5	25	12	30	40	22	41	19,5	30	27	27	28,76	FI-RSW-14SM-DK-B-W3	
16		400	M22x1,5	27	12	30	40	21,5	43	21,5	30	27	30	27,40	FI-RSW-16SM-DK-B-W3	
20		315	M27x2	32	16	36,5	47,5	26	48	24	36	32	36	45,17	FI-RSW-20SM-DK-B-W3	
25		250	M33x2	39	18	43	55	31	59	30,5	46	41	46	30,63	FI-RSW-25SM-DK-B-W3	
30		250	M42x2	49	20	50	63	36,5	70	35,5	55	50	50	149,83	FI-RSW-30SM-DK-B-W3	
38		250	M48x2	55	22	57	72	41	80	40,5	65	55	60	236,07	FI-RSW-38SM-DK-B-W3	

Ordering Codes
***FI-RSW*-10*L*M*-DK*-B*-W3*-MS**

- * Banjo Elbow (High-Pressure Version) **FI-RSW**
- * Outside Tube Diameter D1 (in mm) **-10**
- * Series **L**
Light Series
S
Heavy Series
- * Thread Type **M**
Metric Parallel Thread
- If required, please indicate special sizes, e.g. M12x1.5!
- * Seal Type **-DK**
External Metallic Sealing Ring
- * Seal Material **-B**
NBR (Buna-N®)
-V
FKM (Viton®)
- * Material Code **-W3**
Steel, zinc/nickel-plated
- * Assembling / Kitting **—**
Fitting body only
- MS**
Fitting body supplied with cutting ring and union nut
- MSV**
Fitting body supplied with soft-sealing cutting ring and union nut

¹ Approx.imate dimension in assembled condition.

² Weight excluding cutting ring and union nut.

³ Standard scope of delivery: Fitting body only.

Port acc. to DIN 3852-1 (Form X) / ISO 9974-1

Male threaded studs were designed for female threaded ports in components made of steel. For applications with components made of softer mating materials (e.g. Aluminium), the use of connectors with additionally rolled male threads is recommended.

Please contact STAUFF prior to the assembly for further information.

Standard seal material is NBR (Buna-N®).



For use with aggressive media and/or at elevated temperatures, please remove the o-ring from the groove located on the banjo bolt prior to installation.

Connecting Parts

-  Cutting Ring
Type **FI-DS** Page 28
-  Soft-Sealing Cutting Ring
Type **FI-WDD5** Page 29
-  Support Sleeve
Type **FI-VH** Page 31
-  STAUFF Form EVO Sealing Ring
Type **FI-FD** Page 32
-  Union Nut
Type **FI-M** Page 33
-  37° Flared Tube Fitting Set
Type **FI-AB** Page 37

Spare Parts / Accessories

-  External Metallic Sealing Ring
Type **FI-DKR** Page 245
-  O-Ring
Type **O-RING** Page 239



Banjo Elbow (High-Pressure Version)
Type FI-RSW-...-R-WD ▪ Series L / S

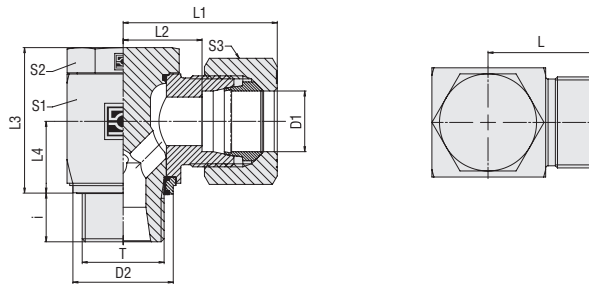

Whitworth Parallel Pipe Thread (BSPP)

Retaining Ring with Captive Seal

Ordering Codes

***FI-RSW*-10*L*R*-WD*-B*-W3*-MS**

* Banjo Elbow (High-Pressure Version) **FI-RSW**

* Outside Tube Diameter D1 (in mm) **-10**

* Series Light Series **L**
 Heavy Series **S**

* Thread Type Whitworth Parallel Pipe Thread (BSPP) **R**

If required, please indicate special sizes, e.g. R1/8!

* Seal Type Retaining Ring with Captive Seal **-WD**

* Seal Material NBR (Buna-N®) **-B**
 FKM (Viton®) **-V**

* Material Code Steel, zinc/nickel-plated **-W3**

Please contact STAUFF for alternative materials and surface finishings.

* Assembling / Kitting Fitting body only **—**

Fitting body supplied with cutting ring and union nut **-MS**

Fitting body supplied with soft-sealing cutting ring and union nut **-MSV**

Series	Tube OD mm D1	PB bar	Dimensions mm											Weight kg ca. per 100	Ordering Codes ³
			Thread	T	D2	i	L	L1 ¹	L2	L3	L4	S1	S2		
L	6	500	G 1/8	14,9	8	20	28	13	21	10,5	14	14	14	3,65	FI-RSW-06LR-WD-B-W3
	6	500	G 1/4	18,8	9,8	22	28	15	27,7	13,5	19	19	14	7,88	FI-RSW-06LR1/4-WD-B-W3
	8	500	G 1/4	18,8	10	21	29	14	27	13,5	19	19	17	7,92	FI-RSW-08LR-WD-B-W3
	10	500	G 1/4	18,8	10	22	30	15	27	13,5	19	19	19	8,16	FI-RSW-10LR-WD-B-W3
	12	400	G 1/4	18,8	9,8	22	31	15	30,7	15,5	22	19	22	10,06	FI-RSW-12LR1/4-WD-B-W3
	12	400	G 3/8	22,8	12	24,5	32,5	17,5	32,5	16	24	22	22	13,94	FI-RSW-12LR-WD-B-W3
	15	400	G 1/2	27,9	14	27	35	21	43	19,5	30	27	27	26,03	FI-RSW-15LR-WD-B-W3
	18	400	G 1/2	27,9	12	28	37	20,5	43	21,5	30	27	32	26,75	FI-RSW-18LR-WD-B-W3
	22	250	G 3/4	32,9	16	34,5	43,5	27	48	24	36	32	36	42,37	FI-RSW-22LR-WD-B-W3
	28	250	G 1	40,9	18	39	48	31,5	59	30,5	46	41	41	84,00	FI-RSW-28LR-WD-B-W3
	35	250	G 1 1/4	50,9	20	46	57	35,5	70	35,5	55	50	50	140,00	FI-RSW-35LR-WD-B-W3
	42	250	G 1 1/2	55,9	22	51	63	40	80	40,5	65	55	60	214,30	FI-RSW-42LR-WD-B-W3
S	6	500	G 1/4	18,8	10	23	31	16	27	13,5	19	19	17	8,36	FI-RSW-06SR-WD-B-W3
	8	500	G 1/4	18,8	10	23	31	16	27	13,5	19	19	19	8,63	FI-RSW-08SR-WD-B-W3
	10	500	G 3/8	22,8	10	25,5	34,5	18	32,5	16	24	22	22	14,36	FI-RSW-10SR-WD-B-W3
	12	400	G 3/8	22,8	10	27	36	18	32,5	16	24	22	24	14,86	FI-RSW-12SR-WD-B-W3
	14	400	G 1/2	27,9	14	30	40	22	41	19,5	30	27	27	26,74	FI-RSW-14SR-WD-B-W3
	16	400	G 1/2	27,9	12	30	40	21,5	43	21,5	30	27	30	27,23	FI-RSW-16SR-WD-B-W3
	20	315	G 3/4	32,9	16	36,5	47,5	26	48	24	36	32	36	44,33	FI-RSW-20SR-WD-B-W3
	25	250	G 1	40,9	18	43	55	31	59	30,5	46	41	46	86,90	FI-RSW-25SR-WD-B-W3
	30	250	G 1 1/4	50,9	20	50	63	36,5	70	35,5	55	50	50	144,70	FI-RSW-30SR-WD-B-W3
	38	250	G 1 1/2	55,9	22	57	72	41	80	40,5	65	55	60	223,60	FI-RSW-38SR-WD-B-W3

¹ Approximate dimension in assembled condition.

² Weight excluding cutting ring and union nut.

³ Standard scope of delivery: Fitting body only.

Port acc. to DIN 3852-2 (Form X) / ISO 1179-1

Male threaded studs were designed for female threaded ports in components made of steel. For applications with components made of softer mating materials (e.g. Aluminium), the use of connectors with additionally rolled male threads is recommended.



Please contact STAUFF prior to the assembly for further information.

Standard seal material is NBR (Buna-N®).

Connecting Parts

-  Cutting Ring
Type **FI-DS** Page 28
-  Soft-Sealing Cutting Ring
Type **FI-WDDS** Page 29
-  Support Sleeve
Type **FI-VH** Page 31
-  STAUFF Form EVO Sealing Ring
Type **FI-FD** Page 32
-  Union Nut
Type **FI-M** Page 33
-  37° Flared Tube Fitting Set
Type **FI-AB** Page 37

Spare Parts / Accessories

-  Retaining Ring with Captive Seal
Type **FI-DIR** Page 245
-  O-Ring
Type **O-RING** Page 239

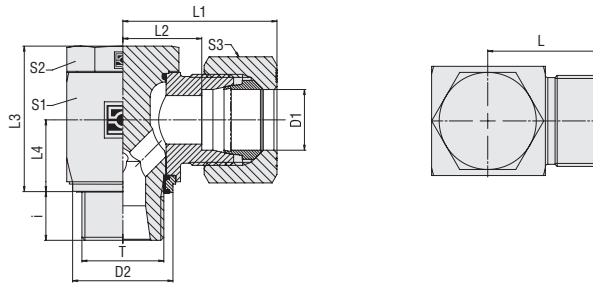

**Banjo Elbow (High-Pressure Version)
Type FI-RSW-...-M-WD ■ Series L / S**

Retaining Ring with Captive Seal
Metric Parallel Thread

Series	Tube OD mm	PB bar	Dimensions mm													Weight kg ca. per 100	Ordering Codes ³
			Thread	T	D2	i	L	L1 ¹	L2	L3	L4	S1	S2	S3			
L	6	500	M10x1	14,9	8	20	28	13	21	10	14	14	14	3,68	FI-RSW-06LM-WD-B-W3		
	8	500	M12x1,5	17,8	10	21	29	14	27	13,5	19	19	17	7,68	FI-RSW-08LM-WD-B-W3		
	10	500	M14x1,5	19,9	10	22	30	15	27	13,5	19	19	19	8,28	FI-RSW-10LM-WD-B-W3		
	12	400	M16x1,5	22,8	10	24,5	32,5	17,5	32,5	16	24	22	22	13,60	FI-RSW-12LM-WD-B-W3		
	12	400	M18x1,5	24,5	14,7	26	32,5	19	37,8	13,6	27	24	22	18,73	FI-RSW-12LM18x1,5-WD-B-W3		
	15	400	M18x1,5	24,9	10	27	35	20	37	18,5	27	24	27	19,21	FI-RSW-15LM-WD-B-W3		
	18	400	M22x1,5	27,9	12	28	37	20,5	43	21,5	30	27	32	27,12	FI-RSW-18LM-WD-B-W3		
	22	250	M26x1,5	32,5	16	34,5	43,5	27	48	24	36	32	36	42,64	FI-RSW-22LM-WD-B-W3		
	28	250	M33x2	40,9	18	39	48	31,5	59	30,5	46	41	41	95,43	FI-RSW-28LM-WD-B-W3		
	35	250	M42x2	50,9	20	46	57	35,5	70	35,5	55	50	50	146,83	FI-RSW-35LM-WD-B-W3		
	42	250	M48x2	55,9	22	51	63	40	80	40,5	65	55	60	221,72	FI-RSW-42LM-WD-B-W3		
	S	6	500	M12x1,5	17,8	10	23	31	16	27	13,5	19	19	17	8,10	FI-RSW-06SM-WD-B-W3	
		8	500	M14x1,5	19,9	10	23	31	16	27	13,5	19	19	19	8,80	FI-RSW-08SM-WD-B-W3	
		10	500	M16x1,5	22,8	10	25,5	34,5	18	32,5	16	24	22	22	14,19	FI-RSW-10SM-WD-B-W3	
12		400	M18x1,5	24,9	10	27	36	19,5	37	18,5	27	24	24	19,53	FI-RSW-12SM-WD-B-W3		
14		400	M20x1,5	27,5	12	30	40	22	41	19,5	30	27	27	29,38	FI-RSW-14SM-WD-B-W3		
16		400	M22x1,5	27,9	12	30	40	21,5	43	21,5	30	27	30	27,53	FI-RSW-16SM-WD-B-W3		
20		315	M27x2	32,9	16	36,5	47,5	26	48	24	36	32	36	44,30	FI-RSW-20SM-WD-B-W3		
25		250	M33x2	40,9	18	43	55	31	59	30,5	46	41	46	224,50	FI-RSW-25SM-WD-B-W3		
30		250	M42x2	50,9	20	50	63	36,5	70	35,5	55	50	50	150,16	FI-RSW-30SM-WD-B-W3		
38		250	M48x2	55,9	22	57	72	41	80	40,5	65	55	60	224,90	FI-RSW-38SM-WD-B-W3		

¹ Approx.imate dimension in assembled condition.

² Weight excluding cutting ring and union nut.

³ Standard scope of delivery: Fitting body only.

Standard seal material is NBR (Buna-N®).

Port acc. to DIN 3852-1 (Form X) / ISO 9974-1

Male threaded studs were designed for female threaded ports in components made of steel. For applications with components made of softer mating materials (e.g. Aluminium), the use of connectors with additionally rolled male threads is recommended.

Please contact STAUFF prior to the assembly for further information.

Ordering Codes
***FI-RSW*-10*L*M*-WD*-B*-W3*-MS**

 * Banjo Elbow (High-Pressure Version) **FI-RSW**

 * Outside Tube Diameter D1 (in mm) **-10**

 * Series Light Series **L**
 Heavy Series **S**

 * Thread Type Metric Parallel Thread **M**

If required, please indicate special sizes, e.g. M12x1.5!

 * Seal Type Retaining Ring with Captive Seal **-WD**

 * Seal Material NBR (Buna-N®) **-B**
 FKM (Viton®) **-V**

 * Material Code Steel, zinc/nickel-plated **-W3**

Please contact STAUFF for alternative materials and surface finishings.

 * Assembling / Kitting Fitting body only **—**

 Fitting body supplied with cutting ring and union nut **-MS**

 Fitting body supplied with soft-sealing cutting ring and union nut **-MSV**
Connecting Parts

	Cutting Ring Type FI-DS	Page 28
	Soft-Sealing Cutting Ring Type FI-WDDS	Page 29
	Support Sleeve Type FI-VH	Page 31
	STAUFF Form EVO Sealing Ring Type FI-FD	Page 32
	Union Nut Type FI-M	Page 33
	37° Flared Tube Fitting Set Type FI-AB	Page 37

Spare Parts / Accessories

	Retaining Ring with Captive Seal Type FI-DIR	Page 245
	O-Ring Type O-RING	Page 239



Banjo Tee (High-Pressure Version) Type FI-RST-...-R-DK ▪ Series L / S

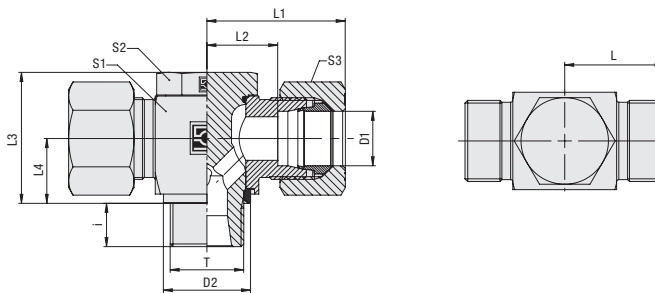

Whitworth Parallel Pipe Thread (BSPP)

External Metallic Sealing Ring

Ordering Codes

***FI-RST*-10*L*R*-DK*-B*-W3*-MS**

* Banjo Tee (High-Pressure Version) **FI-RST**

* Outside Tube Diameter D1 (in mm) **-10**

* Series Light Series **L**
Heavy Series **S**

* Thread Type Whitworth Parallel Pipe Thread (BSPP) **R**

If required, please indicate special sizes, e.g. R1/8!

* Seal Type External Metallic Sealing Ring **-DK**

* Seal Material NBR (Buna-N®) **-B**
FKM (Viton®) **-V**

* Material Code Steel, zinc/nickel-plated **-W3**

Please contact STAUFF for alternative materials and surface finishings.

* Assembling / Kitting Fitting body only **—**

Fitting body supplied with cutting ring and union nut **-MS**

Fitting body supplied with soft-sealing cutting ring and union nut **-MSV**

Series	Tube OD mm D1	PB bar	Dimensions mm											Weight kg ca. per 100	Ordering Codes ³
			Thread	T	D2	i	L	L1 ¹	L2	L3	L4	S1	S2		
L	6	500	G 1/8	13	8	20	28	13	21	10,5	14	14	14	4,57	FI-RST-06LR-DK-B-W3
	8	500	G 1/4	17,8	10	21	29	14	27	13,5	19	19	17	8,60	FI-RST-08LR-DK-B-W3
	10	500	G 1/4	17,8	10	22	30	15	27	13,5	19	19	19	8,93	FI-RST-10LR-DK-B-W3
	12	400	G 3/8	22	12	24,5	32,5	17,5	32,5	16	24	22	22	15,04	FI-RST-12LR-DK-B-W3
	15	400	G 1/2	26	14	27	35	21	43	19,5	30	27	27	30,15	FI-RST-15LR-DK-B-W3
	18	400	G 1/2	26	12	28	37	20,5	43	21,5	30	27	32	31,25	FI-RST-18LR-DK-B-W3
	22	250	G 3/4	32	16	34,5	43,5	27	48	24	36	32	36	46,23	FI-RST-22LR-DK-B-W3
	28	250	G 1	39	18	39	48	31,5	59	30,5	46	41	41	80,19	FI-RST-28LR-DK-B-W3
	35	250	G 1 1/4	49	20	46	57	35,5	70	35,5	55	50	50	145,46	FI-RST-35LR-DK-B-W3
	42	250	G 1 1/2	55	22	51	63	40	80	40,5	65	55	60	217,14	FI-RST-42LR-DK-B-W3
S	6	500	G 1/4	17,8	10	23	31	16	27	13,5	19	19	17	9,48	FI-RST-06SR-DK-B-W3
	8	500	G 1/4	17,8	10	23	31	16	27	13,5	19	19	19	9,97	FI-RST-08SR-DK-B-W3
	10	500	G 3/8	22	10	25,5	34,5	18	32,5	16	24	22	22	19,10	FI-RST-10SR-DK-B-W3
	12	400	G 3/8	22	10	27	36	18	32,5	16	24	22	24	16,38	FI-RST-12SR-DK-B-W3
	14	400	G 1/2	26	14	30	40	22	41	19,5	30	27	27	91,00	FI-RST-14SR-DK-B-W3
	16	400	G 1/2	26	12	30	40	21,5	43	21,5	30	27	30	31,85	FI-RST-16SR-DK-B-W3
	20	315	G 3/4	32	16	36,5	47,5	26	48	24	36	32	36	48,45	FI-RST-20SR-DK-B-W3
	25	250	G 1	39	18	43	55	31	59	30,5	46	41	46	93,55	FI-RST-25SR-DK-B-W3
	30	250	G 1 1/4	49	20	50	63	36,5	70	35,5	55	50	50	153,59	FI-RST-30SR-DK-B-W3
	38	250	G 1 1/2	55	22	57	72	41	80	40,5	65	55	60	236,22	FI-RST-38SR-DK-B-W3

¹ Approximate dimension in assembled condition.

² Weight excluding cutting ring and union nut.

³ Standard scope of delivery: Fitting body only.

Port acc. to DIN 3852-2 (Form X) / ISO 1179-1

Male threaded studs were designed for female threaded ports in components made of steel. For applications with components made of softer mating materials (e.g. Aluminium), the use of connectors with additionally rolled male threads is recommended.

Please contact STAUFF prior to the assembly for further information.



For use with aggressive media and/or at elevated temperatures, please remove the O-ring from the groove located on the banjo bolt prior to installation.

Standard seal material is NBR (Buna-N®).

Connecting Parts

-  Cutting Ring
Type **FI-DS** Page 28
-  Soft-Sealing Cutting Ring
Type **FI-WDDS** Page 29
-  Support Sleeve
Type **FI-VH** Page 31
-  STAUFF Form EVO Sealing Ring
Type **FI-FD** Page 32
-  Union Nut
Type **FI-M** Page 33
-  37° Flared Tube Fitting Set
Type **FI-AB** Page 37

Spare Parts / Accessories

-  External Metallic Sealing Ring
Type **FI-DKR** Page 245
-  O-Ring
Type **O-RING** Page 239

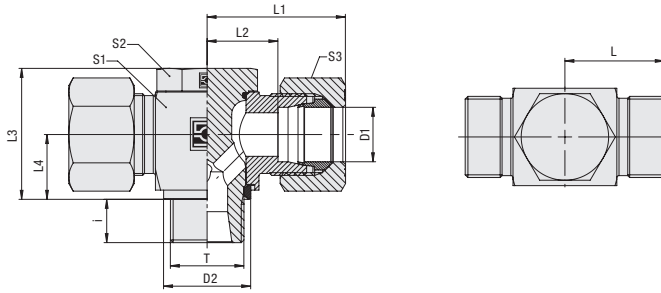

**Banjo Tee (High-Pressure Version)
Type FI-RST-...-M-DK ■ Series L / S**

External Metallic Sealing Ring
Metric Parallel Thread

Series	Tube OD mm	PB bar	Dimensions mm											Weight kg ca. per 100	Ordering Codes ³
			Thread	T	D2	i	L	L1 ¹	L2	L3	L4	S1	S2		
L	6	500	M10x1	13	8	20	28	13	21	10	14	14	14	4,59	FI-RST-06LM-DK-B-W3
	8	500	M12x1,5	17,8	10	21	29	14	27	13,5	19	19	17	9,66	FI-RST-08LM-DK-B-W3
	10	500	M14x1,5	17,8	10	22	30	15	27	13,5	19	19	19	11,05	FI-RST-10LM-DK-B-W3
	12	400	M16x1,5	21	10	24,5	32,5	17,5	32,5	16	24	22	22	14,71	FI-RST-12LM-DK-B-W3
	15	400	M18x1,5	23	10	27	35	20	37	18,5	27	24	27	10,80	FI-RST-15LM-DK-B-W3
	18	400	M22x1,5	27	12	28	37	20,5	43	21,5	30	27	32	31,81	FI-RST-18LM-DK-B-W3
	22	250	M26x1,5	31	16	34,5	43,5	27	48	24	36	32	36	44,90	FI-RST-22LM-DK-B-W3
	28	250	M33x2	39	18	39	48	31,5	59	30,5	46	41	41	85,11	FI-RST-28LM-DK-B-W3
	35	250	M42x2	49	20	46	57	35,5	70	35,5	55	50	50	145,36	FI-RST-35LM-DK-B-W3
	42	250	M48x2	55	22	51	63	40	80	40,5	65	55	60	218,24	FI-RST-42LM-DK-B-W3
S	6	500	M12x1,5	17,8	10	23	31	16	27	13,5	19	19	17	11,23	FI-RST-06SM-DK-B-W3
	8	500	M14x1,5	17,8	10	23	31	16	27	13,5	19	19	19	12,02	FI-RST-08SM-DK-B-W3
	10	500	M16x1,5	21	10	25,5	34,5	18	32,5	16	24	22	22	19,01	FI-RST-10SM-DK-B-W3
	12	400	M18x1,5	23	10	27	36	19,5	37	18,5	27	24	24	21,32	FI-RST-12SM-DK-B-W3
	14	400	M20x1,5	25	12	30	40	22	41	19,5	30	27	27	30,96	FI-RST-14SM-DK-B-W3
	16	400	M22x1,5	27	12	30	40	21,5	43	21,5	30	27	30	32,41	FI-RST-16SM-DK-B-W3
	20	315	M27x2	32	16	36,5	47,5	26	48	24	36	32	36	16,50	FI-RST-20SM-DK-B-W3
	25	250	M33x2	39	18	43	55	31	59	30,5	46	41	46	93,47	FI-RST-25SM-DK-B-W3
	30	250	M42x2	49	20	50	63	36,5	70	35,5	55	50	50	153,16	FI-RST-30SM-DK-B-W3
	38	250	M48x2	55	22	57	72	41	80	40,5	65	55	60	237,04	FI-RST-38SM-DK-B-W3

¹ Approx.imate dimension in assembled condition.

² Weight excluding cutting ring and union nut.

³ Standard scope of delivery: Fitting body only.

Standard seal material is NBR (Buna-N®).



For use with aggressive media and/or at elevated temperatures, please remove the o-ring from the groove located on the banjo bolt prior to installation.

Port acc. to DIN 3852-1 (Form X) / ISO 9974-1

Male threaded studs were designed for female threaded ports in components made of steel. For applications with components made of softer mating materials (e.g. Aluminium), the use of connectors with additionally rolled male threads is recommended.

Please contact STAUFF prior to the assembly for further information.

Ordering Codes
***FI-RST*-10*L*M*-DK*-B*-W3*-MS**

 * Banjo Tee (High-Pressure Version) **FI-RST**

 * Outside Tube Diameter D1 (in mm) **-10**

 * Series Light Series **L**
 Heavy Series **S**

 * Thread Type Metric Parallel Thread **M**

If required, please indicate special sizes, e.g. M12x1.5!

 * Seal Type External Metallic Sealing Ring **-DK**

 * Seal Material NBR (Buna-N®) **-B**
 FKM (Viton®) **-V**

 * Material Code Steel, zinc/nickel-plated **-W3**

Please contact STAUFF for alternative materials and surface finishings.

 * Assembling / Kitting Fitting body only **—**

 Fitting body supplied with cutting ring and union nut **-MS**

 Fitting body supplied with soft-sealing cutting ring and union nut **-MSV**
Connecting Parts

	Cutting Ring Type FI-DS	Page 28
	Soft-Sealing Cutting Ring Type FI-WDDS	Page 29
	Support Sleeve Type FI-VH	Page 31
	STAUFF Form EVO Sealing Ring Type FI-FD	Page 32
	Union Nut Type FI-M	Page 33
	37° Flared Tube Fitting Set Type FI-AB	Page 37

Spare Parts / Accessories

	External Metallic Sealing Ring Type FI-DKR	Page 245
	O-Ring Type O-RING	Page 239



Banjo Tee (High-Pressure Version)
Type FI-RST-...-R-WD • Series L / S

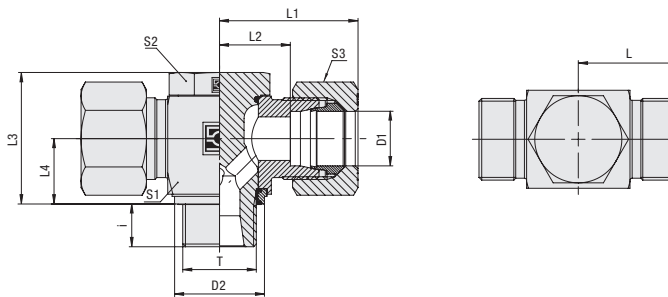

Whitworth Parallel Pipe Thread (BSPP)

Retaining Ring with Captive Seal

Ordering Codes

***FI-RST*-10*L*R*-WD*-B*-W3*-MS**

* Banjo Tee (High-Pressure Version) **FI-RST**

* Outside Tube Diameter D1 (in mm) **-10**

* Series Light Series **L**
 Heavy Series **S**

* Thread Type Whitworth Parallel Pipe Thread (BSPP) **R**

If required, please indicate special sizes, e.g. R1/8!

* Seal Type Retaining Ring with Captive Seal **-WD**

* Seal Material NBR (Buna-N®) **-B**
 FKM (Viton®) **-V**

* Material Code Steel, zinc/nickel-plated **-W3**

Please contact STAUFF for alternative materials and surface finishings.

* Assembling / Kitting Fitting body only **—**

Fitting body supplied with cutting ring and union nut **-MS**

Fitting body supplied with soft-sealing cutting ring and union nut **-MSV**

Series	Tube OD mm D1	PB bar	Dimensions mm											Weight kg ca. per 100	Ordering Codes ³
			Thread	T	D2	i	L	L1 ¹	L2	L3	L4	S1	S2		
L	6	500	G 1/8	14,9	8	20	28	13	21	10,5	14	14	14	4,31	FI-RST-06LR-WD-B-W3
	8	500	G 1/4	18,8	10	21	29	14	27	13,5	19	19	17	8,60	FI-RST-08LR-WD-B-W3
	10	500	G 1/4	18,8	10	22	30	15	27	13,5	19	19	19	8,92	FI-RST-10LR-WD-B-W3
	12	400	G 3/8	22,8	12	24,5	32,5	17,5	32,5	16	24	22	22	14,78	FI-RST-12LR-WD-B-W3
	15	400	G 1/2	27,9	14	27	35	21	43	19,5	30	27	27	27,43	FI-RST-15LR-WD-B-W3
	18	400	G 1/2	27,9	12	28	37	20,5	43	21,5	30	27	32	1,52	FI-RST-18LR-WD-B-W3
	22	250	G 3/4	32,9	16	34,5	43,5	27	48	24	36	32	36	45,42	FI-RST-22LR-WD-B-W3
	28	250	G 1	40,9	18	39	48	31,5	59	30,5	46	41	41	85,48	FI-RST-28LR-WD-B-W3
	35	250	G 1 1/4	50,9	20	46	57	35,5	70	35,5	55	50	50	145,79	FI-RST-35LR-WD-B-W3
	42	250	G 1 1/2	55,9	22	51	63	40	80	40,5	65	55	60	217,42	FI-RST-42LR-WD-B-W3
S	6	500	G 1/4	18,8	10	23	31	16	27	13,5	19	19	17	9,30	FI-RST-06SR-WD-B-W3
	8	500	G 1/4	18,8	10	23	31	16	27	13,5	19	19	19	9,97	FI-RST-08SR-WD-B-W3
	10	500	G 3/8	22,8	10	25,5	34,5	18	32,5	16	24	22	22	19,08	FI-RST-10SR-WD-B-W3
	12	400	G 3/8	22,8	10	27	36	18	32,5	16	24	22	24	16,36	FI-RST-12SR-WD-B-W3
	14	400	G 1/2	27,9	14	30	40	22	41	19,5	30	27	27	31,86	FI-RST-14SR-WD-B-W3
	16	400	G 1/2	27,9	12	30	40	21,5	43	21,5	30	27	30	29,20	FI-RST-16SR-WD-B-W3
	20	315	G 3/4	32,9	16	36,5	47,5	26	48	24	36	32	36	48,66	FI-RST-20SR-WD-B-W3
	25	250	G 1	40,9	18	43	55	31	59	30,5	46	41	46	93,55	FI-RST-25SR-WD-B-W3
	30	250	G 1 1/4	50,9	20	50	63	36,5	70	35,5	55	50	50	153,59	FI-RST-30SR-WD-B-W3
	38	250	G 1 1/2	55,9	22	57	72	41	80	40,5	65	55	60	236,22	FI-RST-38SR-WD-B-W3

¹ Approximate dimension in assembled condition.

² Weight excluding cutting ring and union nut.

³ Standard scope of delivery: Fitting body only.

Standard seal material is NBR (Buna-N®).

Port acc. to DIN 3852-2 (Form X) / ISO 1179-1



Male threaded studs were designed for female threaded ports in components made of steel. For applications with components made of softer mating materials (e.g. Aluminium), the use of connectors with additionally rolled male threads is recommended.

Please contact STAUFF prior to the assembly for further information.

Connecting Parts

-  Cutting Ring
Type **FI-DS** Page 28
-  Soft-Sealing Cutting Ring
Type **FI-WDDS** Page 29
-  Support Sleeve
Type **FI-VH** Page 31
-  STAUFF Form EVO Sealing Ring
Type **FI-FD** Page 32
-  Union Nut
Type **FI-M** Page 33
-  37° Flared Tube Fitting Set
Type **FI-AB** Page 37

Spare Parts / Accessories

-  Retaining Ring with Captive Seal
Type **FI-DIR** Page 245
-  O-Ring
Type **O-RING** Page 239

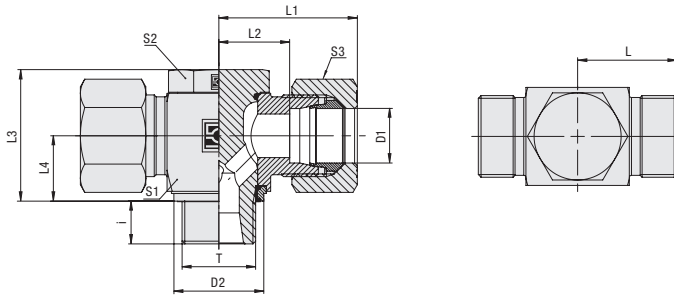

**Banjo Tee (High-Pressure Version)
Type FI-RST-...-M-WD ■ Series L / S**

Retaining Ring with Captive Seal
Metric Parallel Thread

Series	Tube OD mm	PB bar	Dimensions mm	Thread	T	D2	i	L	L1 ¹	L2	L3	L4	S1	S2	S3	Weight kg ca. per 100	Ordering Codes ³
L	6	500	M10x1	14,9	8	20	28	13	21	10	14	14	14	14	14	5,83	FI-RST-06LM-WD-B-W3
	8	500	M12x1,5	17,8	10	21	29	14	27	13,5	19	19	19	17	17	9,66	FI-RST-08LM-WD-B-W3
	10	500	M14x1,5	19,9	10	22	30	15	27	13,5	19	19	19	19	19	13,25	FI-RST-10LM-WD-B-W3
	12	400	M16x1,5	22,8	10	24,5	32,5	17,5	32,5	16	24	22	22	22	22	14,78	FI-RST-12LM-WD-B-W3
	15	400	M18x1,5	24,9	10	27	35	20	37	18,5	27	24	27	27	27	23,90	FI-RST-15LM-WD-B-W3
	18	400	M22x1,5	27,9	12	28	37	20,5	43	21,5	30	27	32	32	32	29,91	FI-RST-18LM-WD-B-W3
	22	250	M26x1,5	32,5	16	34,5	43,5	27	48	24	36	32	36	36	36	42,56	FI-RST-22LM-WD-B-W3
	28	250	M33x2	40,9	18	39	48	31,5	59	30,5	46	41	41	41	41	95,43	FI-RST-28LM-WD-B-W3
	35	250	M42x2	50,9	20	46	57	35,5	70	35,5	55	50	50	50	50	145,36	FI-RST-35LM-WD-B-W3
	42	250	M48x2	55,9	22	51	63	40	80	40,5	65	55	60	60	60	221,72	FI-RST-42LM-WD-B-W3
S	6	500	M12x1,5	17,8	10	23	31	16	27	13,5	19	19	19	17	17	10,08	FI-RST-06SM-WD-B-W3
	8	500	M14x1,5	19,9	10	23	31	16	27	13,5	19	19	19	19	19	10,12	FI-RST-08SM-WD-B-W3
	10	500	M16x1,5	22,8	10	25,5	34,5	18	32,5	16	24	22	22	22	22	14,18	FI-RST-10SM-WD-B-W3
	12	400	M18x1,5	24,9	10	27	36	19,5	37	18,5	27	24	24	24	24	19,66	FI-RST-12SM-WD-B-W3
	14	400	M20x1,5	27,5	12	30	40	22	41	19,5	30	27	27	27	27	29,38	FI-RST-14SM-WD-B-W3
	16	400	M22x1,5	27,9	12	30	40	21,5	43	21,5	30	27	30	30	30	35,10	FI-RST-16SM-WD-B-W3
	20	315	M27x2	32,9	16	36,5	47,5	26	48	24	36	32	36	36	36	45,86	FI-RST-20SM-WD-B-W3
	25	250	M33x2	40,9	18	43	55	31	59	30,5	46	41	46	46	46	82,57	FI-RST-25SM-WD-B-W3
	30	250	M42x2	50,9	20	50	63	36,5	70	35,5	55	50	50	50	50	150,16	FI-RST-30SM-WD-B-W3
	38	250	M48x2	55,9	22	57	72	41	80	40,5	65	55	60	60	60	236,35	FI-RST-38SM-WD-B-W3

Ordering Codes
***FI-RST*-10*L*M*-WD*-B*-W3*-MS**

* Banjo Tee (High-Pressure Version)	FI-RST
* Outside Tube Diameter D1 (in mm)	-10
* Series	Light Series L Heavy Series S
* Thread Type	Metric Parallel Thread M
If required, please indicate special sizes, e.g. M12x1.5!	
* Seal Type	Retaining Ring with Captive Seal -WD
* Seal Material	NBR (Buna-N®) -B FKM (Viton®) -V
* Material Code	Steel, zinc/nickel-plated -W3
Please contact STAUFF for alternative materials and surface finishings.	
* Assembling / Kitting	Fitting body only — Fitting body supplied with cutting ring and union nut -MS Fitting body supplied with soft-sealing cutting ring and union nut -MSV

¹ Approx.imate dimension in assembled condition.

² Weight excluding cutting ring and union nut.

³ Standard scope of delivery: Fitting body only.

Standard seal material is NBR (Buna-N®).

Port acc. to DIN 3852-1 (Form X) / ISO 9974-1

Male threaded studs were designed for female threaded ports in components made of steel. For applications with components made of softer mating materials (e.g. Aluminium), the use of connectors with additionally rolled male threads is recommended.

Please contact STAUFF prior to the assembly for further information.

Connecting Parts

	Cutting Ring Type FI-DS	Page 28
	Soft-Sealing Cutting Ring Type FI-WDDS	Page 29
	Support Sleeve Type FI-VH	Page 31
	STAUFF Form EVO Sealing Ring Type FI-FD	Page 32
	Union Nut Type FI-M	Page 33
	37° Flared Tube Fitting Set Type FI-AB	Page 37

Spare Parts / Accessories

	Retaining Ring with Captive Seal Type FI-DIR	Page 245
	O-Ring Type O-RING	Page 239





Swivel Elbow 196-197
FI-DGWE



Whitworth Parallel Pipe Thread (BSPP) / Retaining Ring with Captive Seal 196
FI-DGWE-...-R-WD



Metric Parallel Thread / Retaining Ring with Captive Seal 197
FI-DGWE-...-M-WD

L



Swivel Elbow
Type FI-DGWE-...-R-WD ▪ Series L / S

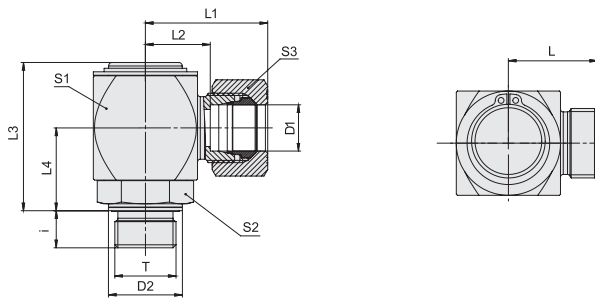

Ordering Codes

***FI-DGWE*-10*L*R*-WD*-B*-W66*-MS**

* Swivel Elbow **FI-DGWE**

* Outside Tube Diameter D1 (in mm) **-10**

* Series Light Series **L**
Heavy Series **S**

* Thread Type Whitworth Parallel Pipe Thread (BSPP) **R**

If required, please indicate special sizes, e.g. R1/8!

* Seal Type Profile Sealing Ring **-WD**

* Seal Material NBR (Buna-N®) **-B**
FKM (Viton®) **-V**

* Material Code Steel, zinc-plated and thick-film-passivated **-W66**

Please contact STAUFF for alternative materials and surface finishings.

* Assembling / Kitting Fitting body only **—**

Fitting body supplied with cutting ring and union nut **-MS**

Fitting body supplied with soft-sealing cutting ring and union nut **-MSV**

Whitworth Parallel Pipe Thread (BSPP)

Profile Sealing Ring

Series	Tube OD mm	PN bar	Dimensions mm											Torque N-m	Weight kg ca. per 100	Ordering Codes ³	
			D1	T	D2	i	L	L1 ¹	L2	L3	L4	S1	S2				S3
L	6	250	G 1/8	14	8	23	31	16	40	21	27	19	14	18	16,00	FI-DGWE-06LR-WD-B-W66	
	6	250	G 1/4	19	12	23	27	16	41	22	27	19	14	40	16,8	FI-DGWE-06LR1/4-WD-B-W66	
	8	250	G 1/4	19	12	25	33	18	46	25	30	22	17	40	23,00	FI-DGWE-08LR-WD-B-W66	
	10	250	G 1/4	19	12	26	34	19	46	25	30	22	19	40	23,40	FI-DGWE-10LR-WD-B-W66	
	10	250	G 3/8	22	12	27	35	20	48	27	32	24	19	80	27,50	FI-DGWE-10LR3/8-WD-B-W66	
	12	250	G 3/8	22	12	27	35	20	48	27	32	24	22	80	28,00	FI-DGWE-12LR-WD-B-W66	
	12	250	G 1/2	27	14	29	37	22	55	30	36	27	22	110	38,80	FI-DGWE-12LR1/2-WD-B-W66	
	15	250	G 1/2	27	14	32	40	25	59	33	40	32	27	110	52,80	FI-DGWE-15LR-WD-B-W66	
	18	160	G 1/2	27	14	32	41	24,5	59	33	40	32	32	110	52,60	FI-DGWE-18LR-WD-B-W66	
	22	160	G 3/4	32	16	36	45	28,5	66	35	45	36	36	180	72,00	FI-DGWE-22LR-WD-B-W66	
	28	100	G 1	40	18	41	50	33,5	78	41	55	41	41	300	126,70	FI-DGWE-28LR-WD-B-W66	
	35	100	G 1 1/4	50	20	48	59	37,5	92	51	65	50	50	470	208,00	FI-DGWE-35LR-WD-B-W66	
	42	100	G 1 1/2	55	22	53	65	42	102	56	75	55	60	540	294,00	FI-DGWE-42LR-WD-B-W66	
	S	6	400	G 1/4	19	12	25	33	18	41	22	27	19	17	50	17,40	FI-DGWE-06SR-WD-B-W66
		8	400	G 1/4	19	12	25	33	18	41	22	27	19	19	50	18,00	FI-DGWE-08SR-WD-B-W66
10		400	G 3/8	22	12	27	36	19,5	46	25	30	22	22	80	24,20	FI-DGWE-10SR-WD-B-W66	
12		400	G 3/8	22	12	28	37	20,5	48	27	32	24	24	80	28,80	FI-DGWE-12SR-WD-B-W66	
14		400	G 1/2	27	14	32	42	24	55	30	36	27	30	120	38,00	FI-DGWE-14SR-WD-B-W66	
16		400	G 1/2	27	14	34	44	25,5	59	33	40	32	30	120	52,80	FI-DGWE-16SR-WD-B-W66	
20		250	G 3/4	32	16	38	49	27,5	66	35	45	36	36	180	74,00	FI-DGWE-20SR-WD-B-W66	
25		250	G 1	40	18	45	57	33	78	41	55	41	46	300	128,00	FI-DGWE-25SR-WD-B-W66	
30		250	G 1 1/4	50	20	52	65	38,5	92	51	65	50	50	470	214,00	FI-DGWE-30SR-WD-B-W66	
38		250	G 1 1/2	55	22	59	74	43	102	56	75	55	60	560	298,00	FI-DGWE-38SR-WD-B-W66	

¹ Approximate dimension in assembled condition.

² Weight excluding cutting ring and union nut.

³ Standard scope of delivery: Fitting body only. Standard seal material is NBR (Buna-N®).

Male stud acc. to ISO 1179-2 (Type E)

Port acc. to ISO 1179-1

Torque recommendations for Steel mating material.

Connecting Parts

- Cutting Ring Type **FI-DS** Page 28
- Soft-Sealing Cutting Ring Type **FI-WDDS** Page 29
- Support Sleeve Type **FI-VH** Page 31
- STAUFF Form EVO Sealing Ring Type **FI-FD** Page 32
- Union Nut Type **FI-M** Page 33
- 37° Flared Tube Fitting Set Type **FI-AB** Page 37

Spare Parts / Accessories

- Profile Sealing Ring Type **WDG** Page 238

Maximum Number of Revolutions per Minute for Permanent Operation

Dimension S1 (mm)	27	30	32	36	40	45	55	65	75
Revolutions Per Minute	6	3	3	1	0,6	0,5	0,4	0,2	0,2

Higher number of revolutions per minute possible when used temporarily / non-permanently. Recommendations for use with hydraulic oil at a static working pressure not exceeding 200 bar.

Male threaded studs were designed for female threaded ports in components made of steel. For applications with components made of softer mating materials (e.g. Aluminium), the use of connectors with additionally rolled male threads is recommended.

Please contact STAUFF prior to the assembly for further information.



Swivel Elbow
Type FI-DGWE-...-M-WD • Series L / S

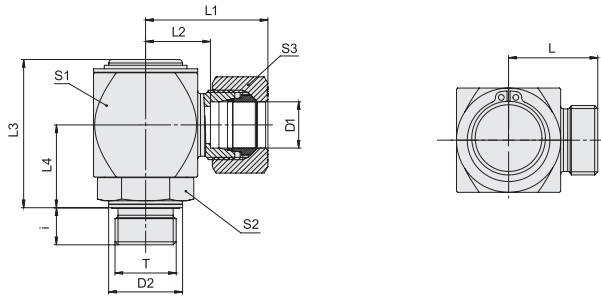

Profile Sealing Ring

Metric Parallel Thread

Series	Tube OD mm D1	PN bar	Dimensions mm													Torque N-m Thread T	Weight kg ca. per 100	Ordering Codes ³
			T	D2	i	L	L ¹	L ²	L ³	L ⁴	S1	S2	S3					
L	6	250	M 10 x 1	14	8	23,5	31,5	16,5	40	21	27	19	14	18	15,60	FI-DGWE-06LM-WD-B-W66		
	6	250	M 12 x 1,5	17	12	23,5	31,5	16,5	41	22	27	19	14	25	16,00	FI-DGWE-06LM12x1.5-WD-B-W66		
	8	250	M 12 x 1,5	17	12	23,5	31,5	16,5	41	22	27	19	17	25	16,80	FI-DGWE-08LM-WD-B-W66		
	8	250	M 14 x 1,5	19	12	25	33	18	46	25	30	22	17	45	23,30	FI-DGWE-08LM14x1.5-WD-B-W66		
	10	250	M 14 x 1,5	19	12	26	34	19	46	25	30	22	19	45	23,00	FI-DGWE-10LM-WD-B-W66		
	10	250	M 16 x 1,5	22	12	27	35	20	48	27	32	24	19	60	24,80	FI-DGWE-10LM16x1.5-WD-B-W66		
	12	250	M 16 x 1,5	22	12	27	35	20	48	27	32	24	22	60	27,50	FI-DGWE-12LM-WD-B-W66		
	12	250	M 18 x 1,5	24	12	29	37	22	55	30	36	27	22	100	39,20	FI-DGWE-12LM18x1.5-WD-B-W66		
	15	250	M 18 x 1,5	24	12	30	38	23	55	30	36	27	27	100	39,00	FI-DGWE-15LM-WD-B-W66		
	15	250	M 22 x 1,5	27	14	32	40	25	59	33	40	32	27	125	52,50	FI-DGWE-15LM22x1.5-WD-B-W66		
	18	160	M 22 x 1,5	27	14	32	41	24,5	59	33	40	32	32	125	53,50	FI-DGWE-18LM-WD-B-W66		
	22	160	M 26 x 1,5	32	16	36,5	45,5	29	66	35	45	36	36	180	70,00	FI-DGWE-22LM-WD-B-W66		
	28	100	M 33 x 2	40	18	41,5	51	34	78	41	55	41	41	300	128,00	FI-DGWE-28LM-WD-B-W66		
	35	100	M 42 x 2	50	20	48,5	59,5	38	92	50	65	50	50	450	206,00	FI-DGWE-35LM-WD-B-W66		
	42	100	M 48 x 2	55	22	53,5	65,5	42,5	102	56	75	55	60	540	294,00	FI-DGWE-42LM-WD-B-W66		
S	6	400	M 12 x 1,5	17	12	25,5	33,5	18,5	41	22	27	19	17	35	17,20	FI-DGWE-06SM-WD-B-W66		
	8	400	M 14 x 1,5	19	12	25,5	33,5	18,5	41	22	27	19	19	55	18,20	FI-DGWE-08SM-WD-B-W66		
	10	400	M 16 x 1,5	22	12	27	36	19,5	46	25	30	22	22	70	23,80	FI-DGWE-10SM-WD-B-W66		
	12	400	M 18 x 1,5	24	12	28	37	20,5	48	27	32	24	24	90	28,20	FI-DGWE-12SM-WD-B-W66		
	14	400	M 20 x 1,5	26	14	32	42	24	55	30	36	27	30	125	45,00	FI-DGWE-14SM-WD-B-W66		
	16	400	M 22 x 1,5	27	14	34	44	25,5	59	33	40	32	30	135	53,60	FI-DGWE-16SM-WD-B-W66		
	20	250	M 27 x 2	32	16	38,5	49,5	28	66	35	45	36	36	180	71,50	FI-DGWE-20SM-WD-B-W66		
	25	250	M 33 x 2	40	18	45,5	57,5	33,5	78	41	55	41	46	310	128,20	FI-DGWE-25SM-WD-B-W66		
	30	250	M 42 x 2	50	20	52,5	65,5	39	92	51	65	50	50	470	210,00	FI-DGWE-30SM-WD-B-W66		
	38	250	M 48 x 2	55	22	59,5	74,5	43,5	102	56	75	55	60	800	300,00	FI-DGWE-38SM-WD-B-W66		

¹ Approx.imate dimension in assembled condition.

² Weight excluding cutting ring and union nut.

³ Standard scope of delivery: Fitting body only.

Standard seal material is NBR (Buna-N®).

Male stud acc. to ISO 9974-2 (Type E)

Port acc. to ISO 9974-1

Torque recommendations for Steel mating material.

Maximum Number of Revolutions per Minute for Permanent Operation

Dimension S1 (mm)	27	30	32	36	40	45	55	65	75
Revolutions Per Minute	6	3	3	1	0,6	0,5	0,4	0,2	0,2

Higher number of revolutions per minute possible when used temporarily / non-permanently.

Recommendations for use with hydraulic oil at a static working pressure not exceeding 200 bar.

Male threaded studs were designed for female threaded ports in components made of steel. For applications with components made of softer mating materials (e.g. Aluminium), the use of connectors with additionally rolled male threads is recommended.

Please contact STAUFF prior to the assembly for further information.

Ordering Codes

***FI-DGWE*-10*L*M*-WD*-B*-W66*-MS**

* Swivel Elbow FI-DGWE

* Outside Tube Diameter D1 (in mm) -10

* Series Light Series L
Heavy Series S

* Thread Type Metric Parallel Thread M

If required, please indicate special sizes, e.g. M27x2!

* Seal Type Profile Sealing Ring -WD

* Seal Material NBR (Buna-N®) -B
FKM (Viton®) -V

* Material Code Steel, zinc-plated and thick-film-passivated -W66

Please contact STAUFF for alternative materials and surface finishings.

* Assembling / Kitting Fitting body only —

Fitting body supplied with cutting ring and union nut -MS

Fitting body supplied with soft-sealing cutting ring and union nut -MSV

Connecting Parts

	Cutting Ring Type FI-DS	Page 28
	Soft-Sealing Cutting Ring Type FI-WDDS	Page 29
	Support Sleeve Type FI-VH	Page 31
	STAUFF Form EVO Sealing Ring Type FI-FD	Page 32
	Union Nut Type FI-M	Page 33
	37° Flared Tube Fitting Set Type FI-AB	Page 37

Spare Parts / Accessories

	Profile Sealing Ring Type WDG	Page 238
--	----------------------------------	----------





	Check Valve High-Pressure Version FI-RV	200
	Check Valve Standard Version FI-RVA	201
	Male Stud Check Valve (Flow from Stud End) FI-RVV / FI-RVVA	202-205
	Whitworth Parallel Pipe Thread (BSPP) / Profile Sealing Ring (High-Pressure Version) FI-RVV-...-R-WD	202
	Metric Parallel Thread / Profile Sealing Ring (High-Pressure Version) FI-RVV-...-M-WD	203
	Whitworth Parallel Pipe Thread (BSPP) / Profile Sealing Ring (Standard Version) FI-RVVA-...-R-WD	204
	Metric Parallel Thread / Profile Sealing Ring (Standard Version) FI-RVVA-...-M-WD	205
	Male Stud Check Valve (Flow to Stud End) FI-RVZ / FI-RVZA	206-209
	Whitworth Parallel Pipe Thread (BSPP) / Profile Sealing Ring (High-Pressure Version) FI-RVZ-...-R-WD	206
	Metric Parallel Thread / Profile Sealing Ring (High-Pressure Version) FI-RVZ-...-M-WD	207
	Whitworth Parallel Pipe Thread (BSPP) / Profile Sealing Ring (Standard Version) FI-RVZA-...-R-WD	208
	Metric Parallel Thread / Profile Sealing Ring (Standard Version) FI-RVZA-...-M-WD	209
	Female Stud Check Valve FI-RVI / FI-RVIA	210-211
	Female Whitworth Parallel Pipe Thread (BSPP) (High-Pressure Version) FI-RVI-...-R	210
	Female Whitworth Parallel Pipe Thread (BSPP) (Standard Version) FI-RVIA-...-R	211
	Check Valve Installation Kit FI-VES	212
	Alternating Valve FI-WV	213



Check Valve
High-Pressure Version
Type FI-RV • Series L / S

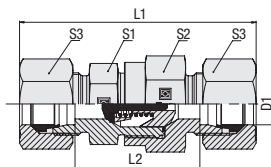

Standard Opening Pressure: 1 bar

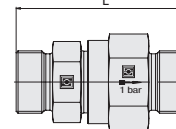

Ordering Codes

***FI-RV*-10*L*-W3*-1*-MS**

- * Check Valve **FI-RV**
- * Outside Tube Diameter D1 (in mm) **-10**
- * Series **L**
S
- * Material Code **-W3**
 Please contact STAUFF for alternative materials and surface finishings.
- * Opening Pressure **1**
 Contact STAUFF for alternative opening pressures.
- * Assembling / Kitting **—**
 Valve body only
- MS**
 Valve body supplied with cutting rings and union nuts
- MSV**
 Valve body supplied with soft-sealing cutting rings and union nuts

Series	Tube OD	PN	Dimensions						Weight kg ca. per 100	Ordering Codes ³
	mm D1		mm L	mm L1 ¹	mm L2	mm S1	mm S2	mm S3		
L	6	400	52	67	38	22	27	14	11,93	FI-RV-06L-W3-1
	8	400	52	67	38	22	27	17	12,41	FI-RV-08L-W3-1
	10	400	52	67	38	22	27	19	11,65	FI-RV-10L-W3-1
	12	400	53	68	39	22	27	22	12,31	FI-RV-12L-W3-1
	15	400	58	74	44	27	32	27	18,29	FI-RV-15L-W3-1
	18	400	63	80	48	27	32	32	22,54	FI-RV-18L-W3-1
	22	250	75	92	60	41	46	36	48,21	FI-RV-22L-W3-1
	28	250	81	99	66	41	46	41	57,90	FI-RV-28L-W3-1
	35	250	92	114	71	60	70	50	129,80	FI-RV-35L-W3-1
	42	250	87	111	65	60	70	60	122,60	FI-RV-42L-W3-1
S	6	400	56	71	42	22	27	17	13,12	FI-RV-06S-W3-1
	8	400	52	67	38	22	27	19	11,98	FI-RV-08S-W3-1
	10	400	54	71	39	22	27	22	13,20	FI-RV-10S-W3-1
	12	400	55	72	40	22	27	24	13,61	FI-RV-12S-W3-1
	14	400	62	81	46	27	32	27	19,98	FI-RV-14S-W3-1
	16	400	65	84	48	27	32	30	21,56	FI-RV-16S-W3-1
	20	400	78	100	57	41	46	36	50,20	FI-RV-20S-W3-1
	25	250	81	105	57	41	46	46	52,60	FI-RV-25S-W3-1
	30	250	91	117	64	50	55	50	80,70	FI-RV-30S-W3-1
	38	250	99	129	67	60	70	60	136,00	FI-RV-38S-W3-1

¹ Approximate dimension in assembled condition.

² Weight excluding cutting rings and union nuts.

³ Standard scope of delivery: Valve body only.

Opening pressure tolerance ± 20%.

Please note: Internal seals are made of FKM (Viton®).

In order to make sure that the valves will be suitable for your particular application, please contact STAUFF with details on media, operating pressure, pressure peaks, operating temperature and the expected frequency of valve actuations.

Connecting Parts

- Cutting Ring
Type **FI-DS** Page 28
- Soft-Sealing Cutting Ring
Type **FI-WDDS** Page 29
- Support Sleeve
Type **FI-VH** Page 31
- STAUFF Form EVO Sealing Ring
Type **FI-FD** Page 32
- Union Nut
Type **FI-M** Page 33
- 37° Flared Tube Fitting Set
Type **FI-AB** Page 37

M



Check Valve Standard Version Type FI-RVA • Series L / S

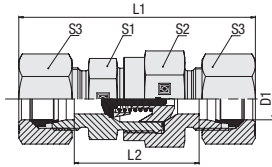

Standard Opening Pressure: 1 bar

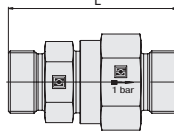

Series	Tube OD mm	PB bar	Dimensions mm						Weight kg ca. per 100	Ordering Codes ³
			L	L1 ¹	L2	S1	S2	S3		
L	6	250	43	58	29	17	17	14	4,4	FI-RVA-06L-W3-1
	8	250	44	59	30	19	19	17	5,5	FI-RVA-08L-W3-1
	10	250	54,5	69,5	40,5	22	24	19	9,8	FI-RVA-10L-W3-1
	12	250	57,5	72,5	43,5	27	30	22	16,5	FI-RVA-12L-W3-1
	15	250	61,5	77,5	47,5	30	32	27	20,5	FI-RVA-15L-W3-1
	18	160	66,5	83,5	51,5	36	36	32	29,0	FI-RVA-18L-W3-1
	22	160	76,5	93,5	61,5	41	46	36	49,5	FI-RVA-22L-W3-1
	28	100	85	103	70	50	55	41	78,4	FI-RVA-28L-W3-1
	35	100	95,5	117,5	74,5	60	65	50	122,7	FI-RVA-35L-W3-1
	42	100	99,5	123,5	77,5	65	75	60	162,6	FI-RVA-42L-W3-1
S	6	630	48,5	63,5	34,5	19	19	17	6,6	FI-RVA-06S-W3-1
	8	630	48,5	63,5	34,5	19	19	19	6,8	FI-RVA-08S-W3-1
	10	630	55,5	72,5	40,5	22	24	22	11,5	FI-RVA-10S-W3-1
	12	630	57,5	74,5	42,5	24	27	24	14,5	FI-RVA-12S-W3-1
	14	630	63,5	82,5	47,5	27	32	27	20,9	FI-RVA-14S-W3-1
	16	400	67,5	86,5	50,5	32	36	30	27,8	FI-RVA-16S-W3-1
	20	400	75,5	97,5	54,5	41	46	36	49,5	FI-RVA-20S-W3-1
	25	400	82,5	106,5	58,5	46	50	46	62,7	FI-RVA-25S-W3-1
	30	250	96	122	69	55	60	50	107,8	FI-RVA-30S-W3-1
	38	250	107,5	137,5	75,5	65	70	60	161,3	FI-RVA-38S-W3-1

¹ Approx.imate dimension in assembled condition.

² Weight excluding cutting rings and union nuts.

³ Standard scope of delivery: Valve body only.

 Opening pressure tolerance \pm 20%.

Please note: Internal seals are made of FKM (Viton®).

In order to make sure that the valves will be suitable for your particular application, please contact STAUFF with details on media, operating pressure, pressure peaks, operating temperature and the expected frequency of valve actuations.

Ordering Codes

***FI-RVA*-10*L*-W3*-1*-MS**

* Check Valve		FI-RVA
* Outside Tube Diameter D1 (in mm)		-10
* Series	Light Series	L
	Heavy Series	S
* Material Code	Steel, zinc/nickel-plated	-W3
Please contact STAUFF for alternative materials and surface finishings.		
* Opening Pressure	1 bar	1
Contact STAUFF for alternative opening pressures.		
* Assembling / Kitting	Valve body only	—
	Valve body supplied with cutting rings and union nuts	-MS
	Valve body supplied with soft-sealing cutting rings and union nuts	-MSV

Connecting Parts

	Cutting Ring Type FI-DS	Page 28
	Soft-Sealing Cutting Ring Type FI-WDDS	Page 29
	Support Sleeve Type FI-VH	Page 31
	STAUFF Form EVO Sealing Ring Type FI-FD	Page 32
	Union Nut Type FI-M	Page 33
	37° Flared Tube Fitting Set Type FI-AB	Page 37



**Male Stud Check Valve
High-Pressure Version
Type FI-RVV-...-R-WD • Series L / S**

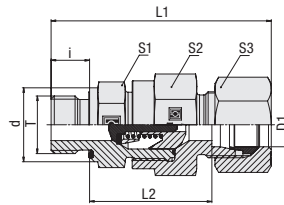

Flow Direction: A > B (from Stud End)

Standard Opening Pressure: 1 bar

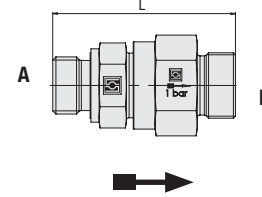

Whitworth Parallel Pipe Thread (BSPP)

Profile Sealing Ring

Ordering Codes

***FI-RVV*-10*L*R*-WD*-B*-W3*-1*-MS**

* Male Stud Check Valve (Flow from Stud End) **FI-RVV**

* Outside Tube Diameter D1 (in mm) **-10**

* Series Light Series **L**
Heavy Series **S**

* Thread Type Whitworth Parallel Pipe Thread (BSPP) **R**

If required, please indicate special sizes, e.g. R1/8!

* Seal Type Profile Sealing Ring **-WD**

* Seal Material NBR (Buna-N®) **-B**
FKM (Viton®) **-V**

* Material Code Steel, zinc/nickel-plated **-W3**

Please contact STAUFF for alternative materials and surface finishings.

* Opening Pressure 1 bar **1**

Contact STAUFF for alternative opening pressures.

* Assembling / Kitting Valve body only **—**

Valve body supplied with cutting ring and union nut **-MS**

Valve body supplied with soft-sealing cutting ring and union nut **-MSV**

Series	Tube OD mm D1	PN bar	Dimensions mm										Torque N-m Thread T	Weight kg ca. per 100	Ordering Codes ³
			Thread	T	d	i	L	L ¹	L2	S1	S2	S3			
L	6	400	G 1/8	13,9	8	51	59	36	22	27	14	18	11,69	FI-RVV-06LR-WD-B-W3-1	
	8	400	G 1/4	18,9	12	55	63	36	22	27	17	35	12,54	FI-RVV-08LR-WD-B-W3-1	
	10	400	G 1/4	18,9	12	53	61	34	22	27	19	35	11,40	FI-RVV-10LR-WD-B-W3-1	
	12	400	G 3/8	21,9	12	58	66	39	22	27	22	70	13,62	FI-RVV-12LR-WD-B-W3-1	
	15	400	G 1/2	26,9	14	60	68	41	27	32	27	90	19,68	FI-RVV-15LR-WD-B-W3-1	
	18	400	G 1/2	26,9	14	67	76	45,5	27	32	32	90	22,68	FI-RVV-18LR-WD-B-W3-1	
	22	250	G 3/4	31,9	16	77	86	53,5	41	46	36	180	46,49	FI-RVV-22LR-WD-B-W3-1	
	28	250	G 1	39,9	18	86	95	60,5	41	46	41	310	59,70	FI-RVV-28LR-WD-B-W3-1	
	35	250	G 1 1/4	49,9	20	97,5	108,5	67	60	70	50	450	132,20	FI-RVV-35LR-WD-B-W3-1	
	42	250	G 1 1/2	54,9	22	97,5	109,5	64,5	60	70	60	540	137,40	FI-RVV-42LR-WD-B-W3-1	
S	6	400	G 1/4	18,9	12	57	65	38	22	27	17	55	12,95	FI-RVV-06SR-WD-B-W3-1	
	8	400	G 1/4	18,9	12	55	63	36	22	27	19	55	12,12	FI-RVV-08SR-WD-B-W3-1	
	10	400	G 3/8	21,9	12	57	66	37,5	22	27	22	80	13,32	FI-RVV-10SR-WD-B-W3-1	
	12	400	G 3/8	21,9	12	59	68	39,5	22	27	24	80	14,64	FI-RVV-12SR-WD-B-W3-1	
	14	400	G 1/2	26,9	14	64	74	42	27	32	27	115	20,26	FI-RVV-14SR-WD-B-W3-1	
	16	400	G 1/2	26,9	14	67	77	44,5	27	32	30	115	21,59	FI-RVV-16SR-WD-B-W3-1	
	20	400	G 3/4	31,9	16	79	90	52,5	41	46	36	180	50,90	FI-RVV-20SR-WD-B-W3-1	
	25	250	G 1	39,9	18	83	95	53	41	46	46	310	53,10	FI-RVV-25SR-WD-B-W3-1	
	30	250	G 1 1/4	49,9	20	94	107	60,5	50	55	50	450	86,00	FI-RVV-30SR-WD-B-W3-1	
	38	250	G 1 1/2	54,9	22	103,5	118,5	65,5	60	70	60	540	143,70	FI-RVV-38SR-WD-B-W3-1	

¹ Approximate dimension in assembled condition.

² Weight excluding cutting ring and union nut.

³ Standard scope of delivery: Valve body only.

Standard seal material is NBR (Buna-N®).

Please note: Internal seals are made of FKM (Viton®).

In order to make sure that the valves will be suitable for your particular application, please contact STAUFF with details on media, operating pressure, pressure peaks, operating temperature and the expected frequency of valve actuations.

Male stud acc. to ISO 1179-2 (Type E)

Port acc. to ISO 1179-1

Torque recommendations for Steel mating material.

Male threaded studs were designed for female threaded ports in components made of steel. For applications with components made of softer mating materials (e.g. Aluminium), the use of connectors with additionally rolled male threads is recommended.

Please contact STAUFF prior to the assembly for further information.

Opening pressure tolerance ± 20%.

Connecting Parts

-  Cutting Ring
Type **FI-DS** Page 28
-  Soft-Sealing Cutting Ring
Type **FI-WDDS** Page 29
-  Support Sleeve
Type **FI-VH** Page 31
-  STAUFF Form EVO Sealing Ring
Type **FI-FD** Page 32
-  Union Nut
Type **FI-M** Page 33
-  37° Flared Tube Fitting Set
Type **FI-AB** Page 37

Spare Parts / Accessories

-  Profile Sealing Ring
Type **WDG** Page 238



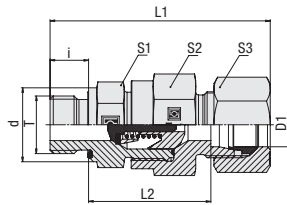

Flow Direction: A > B (from Stud End)

Standard Opening Pressure: 1 bar

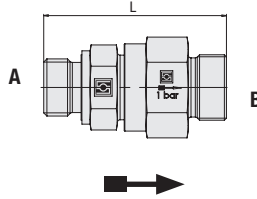

Male Stud Check Valve High-Pressure Version Type FI-RVV-...-M-WD • Series L / S



Profile Sealing Ring

Metric Parallel Thread

Series	Tube OD mm D1	PN bar	Dimensions mm										Torque N-m Thread T	Weight kg ca. per 100	Ordering Codes ³
			Thread	T	d	i	L	L1 ¹	L2	S1	S2	S3			
L	6	400	M 10 x 1	13,9	8	51	59	36	22	27	14	18	10,58	FI-RVV-06LM-WD-B-W3-1	
	8	400	M 12 x 1,5	16,9	12	55	63	36	22	27	17	25	12,28	FI-RVV-08LM-WD-B-W3-1	
	10	400	M 14 x 1,5	18,9	12	53	61	34	22	27	19	45	11,39	FI-RVV-10LM-WD-B-W3-1	
	12	400	M 16 x 1,5	21,9	12	58	66	39	22	27	22	55	13,50	FI-RVV-12LM-WD-B-W3-1	
	15	400	M 18 x 1,5	23,9	12	60	68	41	27	32	27	70	18,42	FI-RVV-15LM-WD-B-W3-1	
	18	400	M 22 x 1,5	26,9	14	67	76	45,5	27	32	32	125	23,09	FI-RVV-18LM-WD-B-W3-1	
	22	250	M 26 x 1,5	31,9	16	77	86	53,5	41	46	36	180	46,70	FI-RVV-22LM-WD-B-W3-1	
	28	250	M 33 x 2	39,9	18	86	95	60,5	41	46	41	310	59,70	FI-RVV-28LM-WD-B-W3-1	
	35	250	M 42 x 2	49,9	20	97,5	108,5	67	60	70	50	450	132,20	FI-RVV-35LM-WD-B-W3-1	
	42	250	M 48 x 2	54,9	22	97,5	109,5	64,5	60	70	60	540	137,20	FI-RVV-42LM-WD-B-W3-1	
	S	6	400	M 12 x 1,5	16,9	12	57	65	38	22	27	17	35	11,23	FI-RVV-06SM-WD-B-W3-1
		8	400	M 14 x 1,5	18,9	12	55	63	36	22	27	19	55	11,55	FI-RVV-08SM-WD-B-W3-1
10		400	M 16 x 1,5	21,9	12	57	66	37,5	22	27	22	70	13,29	FI-RVV-10SM-WD-B-W3-1	
12		400	M 18 x 1,5	23,9	12	59	68	39,5	24	27	24	90	15,56	FI-RVV-12SM-WD-B-W3-1	
14		400	M 20 x 1,5	25,9	14	64	74	42	27	32	27	125	19,94	FI-RVV-14SM-WD-B-W3-1	
16		400	M 22 x 1,5	26,9	14	67	77	44,5	27	32	30	135	21,40	FI-RVV-16SM-WD-B-W3-1	
20		400	M 27 x 2	31,9	16	79	90	52,5	41	46	36	180	50,99	FI-RVV-20SM-WD-B-W3-1	
25		250	M 33 x 2	39,9	18	83	95	53	41	46	46	310	53,50	FI-RVV-25SM-WD-B-W3-1	
30		250	M 42 x 2	49,9	20	94	107	60,5	50	55	50	450	86,80	FI-RVV-30SM-WD-B-W3-1	
38		250	M 48 x 2	54,9	22	104	119	66	60	70	60	540	144,70	FI-RVV-38SM-WD-B-W3-1	

¹ Approx.imate dimension in assembled condition.

² Weight excluding cutting ring and union nut.

³ Standard scope of delivery: Valve body only.

Standard seal material is NBR (Buna-N®).

Please note: Internal seals are made of FKM (Viton®).

In order to make sure that the valves will be suitable for your particular application, please contact STAUFF with details on media, operating pressure, pressure peaks, operating temperature and the expected frequency of valve actuations.

Male stud acc. to ISO 9974-2 (Type E)

Port acc. to ISO 9974-1

Torque recommendations for Steel mating material.

Male threaded studs were designed for female threaded ports in components made of steel. For applications with components made of softer mating materials (e.g. Aluminium), the use of connectors with additionally rolled male threads is recommended.

Please contact STAUFF prior to the assembly for further information.

Opening pressure tolerance ± 20%.

Ordering Codes

***FI-RVV*-10*L*M*-WD*-B*-W3*-1*-MS**

* Male Stud Check Valve (Flow from Stud End) **FI-RVV**

* Outside Tube Diameter D1 (in mm) **-10**

* Series Light Series **L**
Heavy Series **S**

* Thread Type Metric Parallel Thread **M**

If required, please indicate special sizes, e.g. M12x1.5!

* Seal Type Profile Sealing Ring **-WD**

* Seal Material NBR (Buna-N®) **-B**
FKM (Viton®) **-V**

* Material Code Steel, zinc/nickel-plated **-W3**

Please contact STAUFF for alternative materials and surface finishings.

* Opening Pressure 1 bar **1**

Contact STAUFF for alternative opening pressures.

* Assembling / Kitting Fitting body only **-**

Valve body supplied with cutting ring and union nut **-MS**

Valve body supplied with soft-sealing cutting ring and union nut **-MSV**

Connecting Parts

	Cutting Ring Type FI-DS	Page 28
	Soft-Sealing Cutting Ring Type FI-WDDS	Page 29
	Support Sleeve Type FI-VH	Page 31
	STAUFF Form EVO Sealing Ring Type FI-FD	Page 32
	Union Nut Type FI-M	Page 33
	37° Flared Tube Fitting Set Type FI-AB	Page 37

Spare Parts / Accessories

	Profile Sealing Ring Type WDG	Page 238
--	---	----------



**Male Stud Check Valve
Standard Version
Type FI-RVVA-...-R-WD • Series L / S**

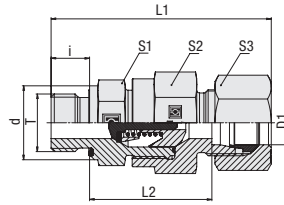

Flow Direction: A > B (from Stud End)

Standard Opening Pressure: 1 bar

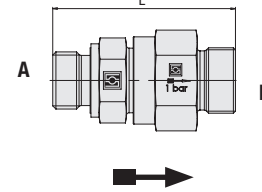

Whitworth Parallel Pipe Thread (BSPP)

Profile Sealing Ring

Ordering Codes

***FI-RVVA*-10*L*R*-WD*-B*-W3*-1*-MS**

* Male Stud Check Valve (Flow from Stud End) **FI-RVVA**

* Outside Tube Diameter D1 (in mm) **-10**

* Series Light Series **L**
Heavy Series **S**

* Thread Type Whitworth Parallel Pipe Thread (BSPP) **R**

If required, please indicate special sizes, e.g. R1/8!

* Seal Type Profile Sealing Ring **-WD**

* Seal Material NBR (Buna-N®) **-B**
FKM (Viton®) **-V**

* Material Code Steel, zinc/nickel-plated **-W3**

Please contact STAUFF for alternative materials and surface finishings.

* Opening Pressure 1 bar **1**

Contact STAUFF for alternative opening pressures.

* Assembling / Kitting Valve body only **—**

Valve body supplied with cutting ring and union nut **-MS**

Valve body supplied with soft-sealing cutting ring and union nut **-MSV**

Series	Tube OD mm D1	PB bar	Dimensions mm										Torque N-m Thread T	Weight kg ca. per 100	Ordering Codes ³
			Thread	T	d	i	L	L ¹	L2	S1	S2	S3			
L	6	250	G 1/8	13,9	8	44	52	29	17	17	14	18	5,7	FI-RVVA-06LR-WD-B-W3-1	
	8	250	G 1/4	18,9	12	49	57	30	19	19	17	35	6,2	FI-RVVA-08LR-WD-B-W3-1	
	10	250	G 1/4	18,9	12	59,5	67,5	40,5	22	24	19	35	10,6	FI-RVVA-10LR-WD-B-W3-1	
	12	250	G 3/8	21,9	12	61,5	69,5	42,5	27	30	22	70	17,2	FI-RVVA-12LR-WD-B-W3-1	
	15	250	G 1/2	26,9	14	66,5	74,5	45,5	30	32	27	90	21,9	FI-RVVA-15LR-WD-B-W3-1	
	18	160	G 1/2	26,9	14	72,5	81,5	51	36	36	32	90	30,1	FI-RVVA-18LR-WD-B-W3-1	
	22	160	G 3/4	31,9	16	80	89	56,5	41	46	36	180	48,8	FI-RVVA-22LR-WD-B-W3-1	
	28	100	G 1	39,9	18	92	101	66,5	50	55	41	310	81,0	FI-RVVA-28LR-WD-B-W3-1	
	35	100	G 1 1/4	49,9	20	102,5	113,5	72	60	65	50	450	126,6	FI-RVVA-35LR-WD-B-W3-1	
	42	100	G 1 1/2	54,9	22	109,5	121,5	76,5	65	75	60	540	170,1	FI-RVVA-42LR-WD-B-W3-1	
S	6	630	G 1/4	18,9	12	50,5	58,5	31,5	19	19	17	55	7,0	FI-RVVA-06SR-WD-B-W3-1	
	8	630	G 1/4	18,9	12	50,5	58,5	31,5	19	19	19	55	6,8	FI-RVVA-08SR-WD-B-W3-1	
	10	630	G 3/8	21,9	12	57,5	66,5	38	22	24	22	80	12,0	FI-RVVA-10SR-WD-B-W3-1	
	12	630	G 3/8	21,9	12	60,5	69,5	41	24	27	24	80	14,9	FI-RVVA-12SR-WD-B-W3-1	
	14	630	G 1/2	26,9	14	66,5	76,5	44,5	27	32	27	115	22,2	FI-RVVA-14SR-WD-B-W3-1	
	16	400	G 1/2	26,9	14	70,5	80,5	48	32	36	30	115	28,1	FI-RVVA-16SR-WD-B-W3-1	
	20	400	G 3/4	31,9	16	78,5	89,5	52	41	46	36	180	50,2	FI-RVVA-20SR-WD-B-W3-1	
	25	400	G 1	39,9	18	87,5	99,5	57,5	46	50	46	310	65,7	FI-RVVA-25SR-WD-B-W3-1	
	30	250	G 1 1/4	49,9	20	97,5	110,5	64	55	60	50	450	108,2	FI-RVVA-30SR-WD-B-W3-1	
	38	250	G 1 1/2	54,9	22	109,5	124,5	71,5	65	70	60	540	162,1	FI-RVVA-38SR-WD-B-W3-1	

¹ Approximate dimension in assembled condition.

² Weight excluding cutting ring and union nut.

³ Standard scope of delivery: Valve body only.

Standard seal material is NBR (Buna-N®).

Please note: Internal seals are made of FKM (Viton®).

In order to make sure that the valves will be suitable for your particular application, please contact STAUFF with details on media, operating pressure, pressure peaks, operating temperature and the expected frequency of valve actuations.

Male stud acc. to ISO 1179-2 (Type E)

Port acc. to ISO 1179-1

Torque recommendations for Steel mating material.

Male threaded studs were designed for female threaded ports in components made of steel. For applications with components made of softer mating materials (e.g. Aluminium), the use of connectors with additionally rolled male threads is recommended.

Please contact STAUFF prior to the assembly for further information.

Opening pressure tolerance ± 20%.

Connecting Parts

-  Cutting Ring
Type **FI-DS** Page 28
-  Soft-Sealing Cutting Ring
Type **FI-WDDS** Page 29
-  Support Sleeve
Type **FI-VH** Page 31
-  STAUFF Form EVO Sealing Ring
Type **FI-FD** Page 32
-  Union Nut
Type **FI-M** Page 33
-  37° Flared Tube Fitting Set
Type **FI-AB** Page 37

Spare Parts / Accessories

-  Profile Sealing Ring
Type **WDG** Page 238



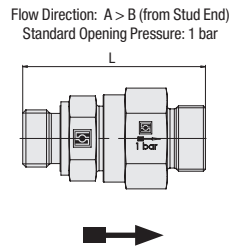
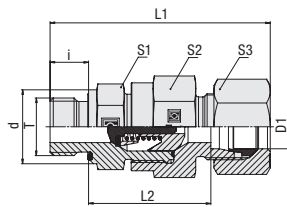

**Male Stud Check Valve
Standard Version
Type FI-RVVA-...-M-WD • Series L / S**



Profile Sealing Ring

Metric Parallel Thread

Series	Tube OD mm D1	PB bar	Dimensions mm										Torque N-m Thread T	Weight kg ca. per 100	Ordering Codes ³
			Thread	T	d	i	L	L1 ¹	L2	S1	S2	S3			
L	6	250	M 10 x 1	13,9	8	44	52	29	17	17	14	18	4,6	FI-RVA-06LM-WD-B-W3-1	
	8	250	M 12 x 1,5	16,9	12	48	56	29	19	19	17	25	7,5	FI-RVA-08LM-WD-B-W3-1	
	10	250	M 14 x 1,5	18,9	12	59	67	40	22	24	19	45	10,6	FI-RVA-10LM-WD-B-W3-1	
	12	250	M 16 x 1,5	21,9	12	61,5	69,5	42,5	27	30	22	55	17,3	FI-RVA-12LM-WD-B-W3-1	
	15	250	M 18 x 1,5	23,9	12	64,5	72,5	45,5	30	32	27	70	20,8	FI-RVA-15LM-WD-B-W3-1	
	18	160	M 22 x 1,5	26,9	14	71,5	80,5	50	36	36	32	125	36,6	FI-RVA-18LM-WD-B-W3-1	
	22	160	M 26 x 1,5	31,9	16	81	90	57,5	41	46	36	180	49,9	FI-RVA-22LM-WD-B-W3-1	
	28	100	M 33 x 2	39,9	18	92	101	66,5	50	55	41	310	81,5	FI-RVA-28LM-WD-B-W3-1	
	35	100	M 42 x 2	49,9	20	101,5	112,5	71	60	65	50	450	124,8	FI-RVA-35LM-WD-B-W3-1	
	42	100	M 48 x 2	54,9	22	109,5	121,5	76,5	65	75	60	540	169,6	FI-RVA-42LM-WD-B-W3-1	
	S	6	630	M 12 x 1,5	16,9	12	50,5	58,5	31,5	19	19	17	35	9,0	FI-RVA-06SM-WD-B-W3-1
		8	630	M 14 x 1,5	18,9	12	50,5	58,5	31,5	19	19	19	55	7,0	FI-RVA-08SM-WD-B-W3-1
10		630	M 16 x 1,5	21,9	12	57,5	66,5	38	22	24	22	70	15,6	FI-RVA-10SM-WD-B-W3-1	
12		630	M 18 x 1,5	23,9	12	60,5	69,5	41	24	27	24	90	15,4	FI-RVA-12SM-WD-B-W3-1	
14		630	M 20 x 1,5	25,9	14	66,5	76,5	44,5	27	32	27	125	27,2	FI-RVA-14SM-WD-B-W3-1	
16		400	M 22 x 1,5	26,9	14	70,5	80,5	48	32	36	30	135	36,0	FI-RVA-16SM-WD-B-W3-1	
20		400	M 27 x 2	31,9	16	78,5	89,5	52	41	46	36	180	50,3	FI-RVA-20SM-WD-B-W3-1	
25		400	M 33 x 2	39,9	18	87	99	57	46	50	46	310	87,3	FI-RVA-25SM-WD-B-W3-1	
30		250	M 42 x 2	49,9	20	99,5	112,5	66	55	60	50	450	113,2	FI-RVA-30SM-WD-B-W3-1	
38		250	M 48 x 2	54,9	22	110	125	72	65	70	60	540	197,3	FI-RVA-38SM-WD-B-W3-1	

¹ Approx.imate dimension in assembled condition.
² Weight excluding cutting ring and union nut.
³ Standard scope of delivery: Valve body only.

Standard seal material is NBR (Buna-N®).
 Please note: Internal seals are made of FKM (Viton®).

In order to make sure that the valves will be suitable for your particular application, please contact STAUFF with details on media, operating pressure, pressure peaks, operating temperature and the expected frequency of valve actuations.

Male stud acc. to ISO 9974-2 (Type E)
 Port acc. to ISO 9974-1

Torque recommendations for Steel mating material.

Male threaded studs were designed for female threaded ports in components made of steel. For applications with components made of softer mating materials (e.g. Aluminium), the use of connectors with additionally rolled male threads is recommended.
 Please contact STAUFF prior to the assembly for further information.

Opening pressure tolerance ± 20%.

Ordering Codes

- *FI-RVVA*-10*L*M*-WD*-B*-W3*-1*-MS
- * Male Stud Check Valve (Flow from Stud End) **FI-RVVA**
- * Outside Tube Diameter D1 (in mm) **-10**
- * Series Light Series **L**
Heavy Series **S**
- * Thread Type Metric Parallel Thread **M**
- If required, please indicate special sizes, e.g. M12x1.5!
- * Seal Type Profile Sealing Ring **-WD**
- * Seal Material NBR (Buna-N®) **-B**
FKM (Viton®) **-V**
- * Material Code Steel, zinc/nickel-plated **-W3**
- Please contact STAUFF for alternative materials and surface finishings.
- * Opening Pressure 1 bar **1**
- Contact STAUFF for alternative opening pressures.
- * Assembling / Kitting Fitting body only **—**
Valve body supplied with cutting ring and union nut **-MS**
Valve body supplied with soft-sealing cutting ring and union nut **-MSV**



Connecting Parts

- Cutting Ring
Type **FI-DS** Page 28
- Soft-Sealing Cutting Ring
Type **FI-WDDS** Page 29
- Support Sleeve
Type **FI-VH** Page 31
- STAUFF Form EVO Sealing Ring
Type **FI-FD** Page 32
- Union Nut
Type **FI-M** Page 33
- 37° Flared Tube Fitting Set
Type **FI-AB** Page 37

Spare Parts / Accessories

- Profile Sealing Ring
Type **WDG** Page 238



**Male Stud Check Valve
High-Pressure Version
Type FI-RVZ-...-R-WD • Series L / S**

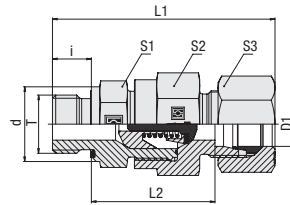

Flow Direction: B > A (to Stud End)
Standard Opening Pressure: 1 bar

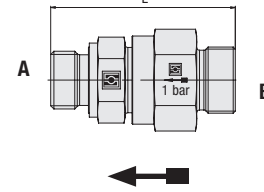

Whitworth Parallel Pipe Thread (BSPP)

Profile Sealing Ring

Ordering Codes

***FI-RVZ*-10*L*R*-WD*-B*-W3*-1*-MS**

* Male Stud Check Valve (Flow to Stud End) **FI-RVZ**

* Outside Tube Diameter D1 (in mm) **-10**

* Series Light Series **L**
Heavy Series **S**

* Thread Type Whitworth Parallel Pipe Thread (BSPP) **R**

If required, please indicate special sizes, e.g. R1/8!

* Seal Type Profile Sealing Ring **-WD**

* Seal Material NBR (Buna-N®) **-B**
FKM (Viton®) **-V**

* Material Code Steel, zinc/nickel-plated **-W3**

Please contact STAUFF for alternative materials and surface finishings.

* Opening Pressure 1 bar **1**

Contact STAUFF for alternative opening pressures.

* Assembling / Kitting Valve body only **—**

Valve body supplied with cutting ring and union nut **-MS**

Valve body supplied with soft-sealing cutting ring and union nut **-MSV**

Series	Tube OD mm D1	PN bar	Dimensions mm										Torque N-m Thread T	Weight kg ca. per 100	Ordering Codes ³
			Thread	T	d	i	L	L ¹	L2	S1	S2	S3			
L	6	400	G 1/8	13,9	8	51	59	36	22	27	14	18	12,07	FI-RVZ-06LR-WD-B-W3-1	
	8	400	G 1/4	18,9	12	55	63	36	22	27	17	35	12,56	FI-RVZ-08LR-WD-B-W3-1	
	10	400	G 1/4	18,9	12	53	61	34	22	27	19	35	11,38	FI-RVZ-10LR-WD-B-W3-1	
	12	400	G 3/8	21,9	12	58	66	39	22	27	22	70	13,64	FI-RVZ-12LR-WD-B-W3-1	
	15	400	G 1/2	26,9	14	62	70	41	27	32	27	90	19,15	FI-RVZ-15LR-WD-B-W3-1	
	18	400	G 1/2	26,9	14	67	76	45,5	27	32	32	90	22,67	FI-RVZ-18LR-WD-B-W3-1	
	22	250	G 3/4	31,9	16	77	86	53,5	46	41	36	180	45,69	FI-RVZ-22LR-WD-B-W3-1	
	28	250	G 1	39,9	18	80	89	54,5	46	41	41	310	52,60	FI-RVZ-30LR-WD-B-W3-1	
	35	250	G 1 1/4	49,9	20	97,5	108,5	67	60	70	50	450	130,70	FI-RVZ-35LR-WD-B-W3-1	
	42	250	G 1 1/2	54,9	22	97,5	109,5	64,5	60	70	60	540	137,40	FI-RVZ-42LR-WD-B-W3-1	
S	6	400	G 1/4	18,9	12	57	65	38	22	27	17	55	12,92	FI-RVZ-06SR-WD-B-W3-1	
	8	400	G 1/4	18,9	12	55	63	36	22	27	19	55	12,18	FI-RVZ-08SR-WD-B-W3-1	
	10	400	G 3/8	21,9	12	57	66	37,5	22	27	22	80	13,30	FI-RVZ-10SR-WD-B-W3-1	
	12	400	G 3/8	21,9	12	59	68	39,5	22	27	24	80	14,64	FI-RVZ-12SR-WD-B-W3-1	
	14	400	G 1/2	26,9	14	64	74	42	27	32	27	115	20,23	FI-RVZ-14SR-WD-B-W3-1	
	16	400	G 1/2	26,9	14	67	77	44,5	27	32	30	115	21,61	FI-RVZ-16SR-WD-B-W3-1	
	20	400	G 3/4	31,9	16	79,5	90,5	53	46	41	36	180	46,63	FI-RVZ-20SR-WD-B-W3-1	
	25	250	G 1	39,9	18	83	95	53	46	41	46	310	53,10	FI-RVZ-25SR-WD-B-W3-1	
	30	250	G 1 1/4	49,9	20	94	107	60,5	50	55	50	450	85,80	FI-RVZ-30SR-WD-B-W3-1	
	38	250	G 1 1/2	54,9	22	103,5	118,5	65,5	60	70	60	540	143,40	FI-RVZ-38SR-WD-B-W3-1	

¹ Approximate dimension in assembled condition.

² Weight excluding cutting ring and union nut.

³ Standard scope of delivery: Valve body only.

Standard seal material is NBR (Buna-N®).

Please note: Internal seals are made of FKM (Viton®).

In order to make sure that the valves will be suitable for your particular application, please contact STAUFF with details on media, operating pressure, pressure peaks, operating temperature and the expected frequency of valve actuations.

Male stud acc. to ISO 1179-2 (Type E)

Port acc. to ISO 1179-1

Torque recommendations for Steel mating material.

Male threaded studs were designed for female threaded ports in components made of steel. For applications with components made of softer mating materials (e.g. Aluminium), the use of connectors with additionally rolled male threads is recommended.

Please contact STAUFF prior to the assembly for further information.

Opening pressure tolerance ± 20%.

Connecting Parts

-  Cutting Ring
Type **FI-DS** Page 28
-  Soft-Sealing Cutting Ring
Type **FI-WDDS** Page 29
-  Support Sleeve
Type **FI-VH** Page 31
-  STAUFF Form EVO Sealing Ring
Type **FI-FD** Page 32
-  Union Nut
Type **FI-M** Page 33
-  37° Flared Tube Fitting Set
Type **FI-AB** Page 37

Spare Parts / Accessories

-  Profile Sealing Ring
Type **WDG** Page 238



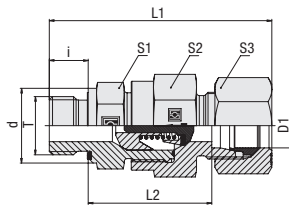

Flow Direction: B > A (to Stud End)
Standard Opening Pressure: 1 bar

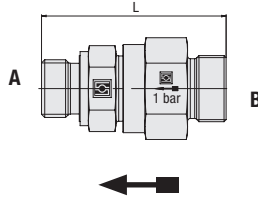

**Male Stud Check Valve
High-Pressure Version
Type FI-RVZ-...-M-WD • Series L / S**



Profile Sealing Ring

Metric Parallel Thread

Series	Tube OD mm D1	PN bar	Dimensions mm										Torque N-m Thread T	Weight kg ca. per 100	Ordering Codes ³
			Thread	T	d	i	L	L1 ¹	L2	S1	S2	S3			
L	6	400	M 10 x 1	13,9	8	51	59	36	22	27	14	18	12,20	FI-RVZ-06LM-WD-B-W3-1	
	8	400	M 12 x 1,5	16,9	12	55	63	36	22	27	17	25	12,31	FI-RVZ-08LM-WD-B-W3-1	
	10	400	M 14 x 1,5	18,9	12	53	61	34	22	27	19	45	11,40	FI-RVZ-10LM-WD-B-W3-1	
	12	400	M 16 x 1,5	21,9	12	58	66	39	22	27	22	55	14,02	FI-RVZ-12LM-WD-B-W3-1	
	15	400	M 18 x 1,5	23,9	12	60	68	41	27	32	27	70	19,06	FI-RVZ-15LM-WD-B-W3-1	
	18	400	M 22 x 1,5	26,9	14	67	76	45,5	27	32	32	125	10,27	FI-RVZ-18LM-WD-B-W3-1	
	22	250	M 26 x 1,5	31,9	16	78	87	54,5	46	41	36	180	46,73	FI-RVZ-22LM-WD-B-W3-1	
	28	250	M 33 x 2	39,9	18	80	89	54,5	46	41	41	310	52,70	FI-RVZ-28LM-WD-B-W3-1	
	35	250	M 42 x 2	49,9	20	97,5	108,5	67	60	70	50	450	132,30	FI-RVZ-35LM-WD-B-W3-1	
	42	250	M 48 x 2	54,9	22	97,5	109,5	64,5	60	70	60	540	137,70	FI-RVZ-42LM-WD-B-W3-1	
	S	6	400	M 12 x 1,5	16,9	12	57	65	38	22	27	17	35	12,66	FI-RVZ-06SM-WD-B-W3-1
		8	400	M 14 x 1,5	18,9	12	55	63	36	22	27	19	55	12,21	FI-RVZ-08SM-WD-B-W3-1
10		400	M 16 x 1,5	21,9	12	57	66	37,5	22	27	22	70	6,64	FI-RVZ-10SM-WD-B-W3-1	
12		400	M 18 x 1,5	23,9	12	59	68	39,5	24	27	24	90	15,58	FI-RVZ-12SM-WD-B-W3-1	
14		400	M 20 x 1,5	25,9	14	64	74	42	27	32	27	125	19,98	FI-RVZ-14SM-WD-B-W3-1	
16		400	M 22 x 1,5	26,9	14	67	77	44,5	27	32	30	135	21,94	FI-RVZ-16SM-WD-B-W3-1	
20		400	M 27 x 2	31,9	16	78	89	51,5	46	41	36	180	53,51	FI-RVZ-20SM-WD-B-W3-1	
25		250	M 33 x 2	39,9	18	83	95	53	46	41	46	310	53,10	FI-RVZ-25SM-WD-B-W3-1	
30		250	M 42 x 2	49,9	20	94	107	60,5	50	55	50	450	86,00	FI-RVZ-30SM-WD-B-W3-1	
38		250	M 48 x 2	54,9	22	103,5	118,5	65,5	60	70	60	540	143,90	FI-RVZ-38SM-WD-B-W3-1	

¹ Approx.imate dimension in assembled condition.
² Weight excluding cutting ring and union nut.
³ Standard scope of delivery: Valve body only.

Standard seal material is NBR (Buna-N®).
Please note: Internal seals are made of FKM (Viton®).

In order to make sure that the valves will be suitable for your particular application, please contact STAUFF with details on media, operating pressure, pressure peaks, operating temperature and the expected frequency of valve actuations.

Male stud acc. to ISO 9974-2 (Type E)
Port acc. to ISO 9974-1

Torque recommendations for Steel mating material.

Male threaded studs were designed for female threaded ports in components made of steel. For applications with components made of softer mating materials (e.g. Aluminium), the use of connectors with additionally rolled male threads is recommended.
Please contact STAUFF prior to the assembly for further information.

Opening pressure tolerance ± 20%.

Ordering Codes

***FI-RVZ*-10*L*M*-WD*-B*-W3*-1*-MS**

- * Male Stud Check Valve (Flow to Stud End) **FI-RVZ**
- * Outside Tube Diameter D1 (in mm) **-10**
- * Series **L**
Light Series
S
Heavy Series
- * Thread Type **M**
Metric Parallel Thread
- If required, please indicate special sizes, e.g. M12x1.5!
- * Seal Type **-WD**
Profile Sealing Ring
- * Seal Material **-B**
NBR (Buna-N®)
-V
FKM (Viton®)
- * Material Code **-W3**
Steel, zinc/nickel-plated
- Please contact STAUFF for alternative materials and surface finishings.
- * Opening Pressure **1**
1 bar
Contact STAUFF for alternative opening pressures.
- * Assembling / Kitting **-**
Valve body supplied with cutting ring and union nut **-MS**
Valve body supplied with soft-sealing cutting ring and union nut **-MSV**

M

Connecting Parts

- Cutting Ring
Type **FI-DS** Page 28
- Soft-Sealing Cutting Ring
Type **FI-WDDS** Page 29
- Support Sleeve
Type **FI-VH** Page 31
- STAUFF Form EVO Sealing Ring
Type **FI-FD** Page 32
- Union Nut
Type **FI-M** Page 33
- 37° Flared Tube Fitting Set
Type **FI-AB** Page 37

Spare Parts / Accessories

- Profile Sealing Ring
Type **WDG** Page 238



**Male Stud Check Valve
Standard Version
Type FI-RVZA...-R-WD • Series L / S**

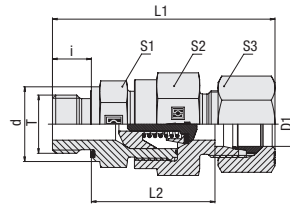

Flow Direction: B > A (to Stud End)
Standard Opening Pressure: 1 bar

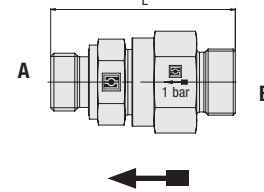

Whitworth Parallel Pipe Thread (BSPP)

Profile Sealing Ring

Ordering Codes

***FI-RVZA*-10*L*R*-WD*-B*-W3*-1*-MS**

* Male Stud Check Valve (Flow to Stud End) **FI-RVZA**

* Outside Tube Diameter D1 (in mm) **-10**

* Series Light Series **L**
Heavy Series **S**

* Thread Type Whitworth Parallel Pipe Thread (BSPP) **R**

If required, please indicate special sizes, e.g. R1/8!

* Seal Type Profile Sealing Ring **-WD**

* Seal Material NBR (Buna-N®) **-B**
FKM (Viton®) **-V**

* Material Code Steel, zinc/nickel-plated **-W3**

Please contact STAUFF for alternative materials and surface finishings.

* Opening Pressure 1 bar **1**

Contact STAUFF for alternative opening pressures.

* Assembling / Kitting Valve body only **—**

Valve body supplied with cutting ring and union nut **-MS**

Valve body supplied with soft-sealing cutting ring and union nut **-MSV**

Series	Tube OD mm D1	PB bar	Dimensions mm										Torque N-m Thread T	Weight kg ca. per 100	Ordering Codes ³
			Thread	T	d	i	L	L1 ¹	L2	S1	S2	S3			
L	6	250	G 1/8	13,9	8	43	51	28	17	17	14	18	4,5	FI-RVZA-06LR-WD-B-W3-1	
	8	250	G 1/4	18,9	12	47,5	55,5	28,5	19	19	17	35	5,8	FI-RVZA-08LR-WD-B-W3-1	
	10	250	G 1/4	18,9	12	59	67	40	22	24	19	35	10,6	FI-RVZA-10LR-WD-B-W3-1	
	12	250	G 3/8	21,9	12	60,5	68,5	41,5	27	30	22	70	16,8	FI-RVZA-12LR-WD-B-W3-1	
	15	250	G 1/2	26,9	14	65	73	44	30	32	27	90	20,8	FI-RVZA-15LR-WD-B-W3-1	
	18	160	G 1/2	26,9	14	69,5	78,5	48	36	36	32	90	28,0	FI-RVZA-18LR-WD-B-W3-1	
	22	160	G 3/4	31,9	16	80,5	89,5	57	41	46	36	180	49,4	FI-RVZA-22LR-WD-B-W3-1	
	28	100	G 1	39,9	18	92,5	101,5	67	50	55	41	310	81,9	FI-RVZA-28LR-WD-B-W3-1	
	35	100	G 1 1/4	49,9	20	102	113	71,5	60	65	50	450	121,7	FI-RVZA-35LR-WD-B-W3-1	
	42	100	G 1 1/2	54,9	22	108,5	120,5	75,5	65	75	60	540	167,2	FI-RVZA-42LR-WD-B-W3-1	
S	6	630	G 1/4	18,9	12	50,5	58,5	31,5	19	19	17	55	7,0	FI-RVZA-06SR-WD-B-W3-1	
	8	630	G 1/4	18,9	12	50,5	58,5	31,5	19	19	19	55	6,9	FI-RVZA-08SR-WD-B-W3-1	
	10	630	G 3/8	21,9	12	57,5	66,5	38	22	24	22	80	12,0	FI-RVZA-10SR-WD-B-W3-1	
	12	630	G 3/8	21,9	12	60,5	69,5	41	24	27	24	80	15,0	FI-RVZA-12SR-WD-B-W3-1	
	14	630	G 1/2	26,9	14	65,5	75,5	43,5	27	32	27	115	21,6	FI-RVZA-14SR-WD-B-W3-1	
	16	400	G 1/2	26,9	14	70,5	80,5	48	32	36	30	115	28,0	FI-RVZA-16SR-WD-B-W3-1	
	20	400	G 3/4	31,9	16	78,5	89,5	52	41	46	36	180	50,7	FI-RVZA-20SR-WD-B-W3-1	
	25	400	G 1	39,9	18	87	99	57	46	50	46	310	65,6	FI-RVZA-25SR-WD-B-W3-1	
	30	250	G 1 1/4	49,9	20	99,5	112,5	66	55	60	50	450	108,5	FI-RVZA-30SR-WD-B-W3-1	
	38	250	G 1 1/2	54,9	22	110,5	125,5	72,5	65	70	60	540	161,8	FI-RVZA-38SR-WD-B-W3-1	

¹ Approximate dimension in assembled condition.

² Weight excluding cutting ring and union nut.

³ Standard scope of delivery: Valve body only.

Standard seal material is NBR (Buna-N®).

Please note: Internal seals are made of FKM (Viton®).

In order to make sure that the valves will be suitable for your particular application, please contact STAUFF with details on media, operating pressure, pressure peaks, operating temperature and the expected frequency of valve actuations.

Male stud acc. to ISO 1179-2 (Type E)

Port acc. to ISO 1179-1

Torque recommendations for Steel mating material.

Male threaded studs were designed for female threaded ports in components made of steel. For applications with components made of softer mating materials (e.g. Aluminium), the use of connectors with additionally rolled male threads is recommended.

Please contact STAUFF prior to the assembly for further information.

Opening pressure tolerance ± 20%.

Connecting Parts

-  Cutting Ring
Type **FI-DS** Page 28
-  Soft-Sealing Cutting Ring
Type **FI-WDDS** Page 29
-  Support Sleeve
Type **FI-VH** Page 31
-  STAUFF Form EVO Sealing Ring
Type **FI-FD** Page 32
-  Union Nut
Type **FI-M** Page 33
-  37° Flared Tube Fitting Set
Type **FI-AB** Page 37

Spare Parts / Accessories

-  Profile Sealing Ring
Type **WDG** Page 238



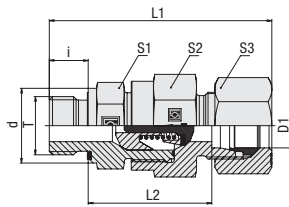

Flow Direction: B > A (to Stud End)
Standard Opening Pressure: 1 bar

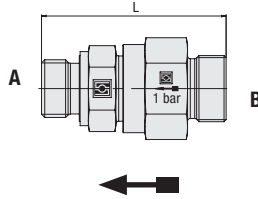

**Male Stud Check Valve
Standard Version
Type FI-RVZA-...-M-WD • Series L / S**



Profile Sealing Ring

Metric Parallel Thread

Series	Tube OD mm D1	PB bar	Dimensions mm										Torque N-m Thread T	Weight kg ca. per 100	Ordering Codes ³
			Thread	T	d	i	L	L1 ¹	L2	S1	S2	S3			
L	6	250	M 10 x 1	13,9	8	43	51	28	17	17	14	18	5,7	FI-RVZA-06LM-WD-B-W3-1	
	8	250	M 12 x 1,5	16,9	12	47,5	55,5	28,5	19	19	17	25	5,5	FI-RVZA-08LM-WD-B-W3-1	
	10	250	M 14 x 1,5	18,9	12	57,5	65,5	38,5	22	24	19	45	10,3	FI-RVZA-10LM-WD-B-W3-1	
	12	250	M 16 x 1,5	21,9	12	60	68	41	27	30	22	55	16,5	FI-RVZA-12LM-WD-B-W3-1	
	15	250	M 18 x 1,5	23,9	12	63	71	44	30	32	27	70	19,9	FI-RVZA-15LM-WD-B-W3-1	
	18	160	M 22 x 1,5	26,9	14	69,5	78,5	48	36	36	32	125	28,3	FI-RVZA-18LM-WD-B-W3-1	
	22	160	M 26 x 1,5	31,9	16	79,5	88,5	56	41	46	36	180	47,9	FI-RVZA-22LM-WD-B-W3-1	
	28	100	M 33 x 2	39,9	18	91	100	65,5	50	55	41	310	79,4	FI-RVZA-28LM-WD-B-W3-1	
	35	100	M 42 x 2	49,9	20	102	113	71,5	60	65	50	450	125,8	FI-RVZA-35LM-WD-B-W3-1	
	42	100	M 48 x 2	54,9	22	108,5	120,5	75,5	65	75	60	540	194,0	FI-RVZA-42LM-WD-B-W3-1	
S	6	630	M 12 x 1,5	16,9	12	50,5	58,5	31,5	19	19	17	35	9,3	FI-RVZA-06SM-WD-B-W3-1	
	8	630	M 14 x 1,5	18,9	12	50,5	58,5	31,5	19	19	19	55	9,2	FI-RVZA-08SM-WD-B-W3-1	
	10	630	M 16 x 1,5	21,9	12	57,5	66,5	38	22	24	22	70	11,8	FI-RVZA-10SM-WD-B-W3-1	
	12	630	M 18 x 1,5	23,9	12	60,5	69,5	41	24	27	24	90	18,9	FI-RVZA-12SM-WD-B-W3-1	
	14	630	M 20 x 1,5	25,9	14	65,5	75,5	43,5	27	32	27	125	27,9	FI-RVZA-14SM-WD-B-W3-1	
	16	400	M 22 x 1,5	26,9	14	69	79	46,5	32	36	30	135	27,5	FI-RVZA-16SM-WD-B-W3-1	
	20	400	M 27 x 2	31,9	16	78,5	89,5	52	41	46	36	180	50,3	FI-RVZA-20SM-WD-B-W3-1	
	25	400	M 33 x 2	39,9	18	87	99	57	46	50	46	310	65,5	FI-RVZA-25SM-WD-B-W3-1	
	30	250	M 42 x 2	49,9	20	99,5	112,5	66	55	60	50	450	133,8	FI-RVZA-30SM-WD-B-W3-1	
	38	250	M 48 x 2	54,9	22	110,5	125,5	72,5	65	70	60	540	196,9	FI-RVZA-38SM-WD-B-W3-1	

¹ Approx.imate dimension in assembled condition.
² Weight excluding cutting ring and union nut.
³ Standard scope of delivery: Valve body only.

Standard seal material is NBR (Buna-N®).
Please note: Internal seals are made of FKM (Viton®).

In order to make sure that the valves will be suitable for your particular application, please contact STAUFF with details on media, operating pressure, pressure peaks, operating temperature and the expected frequency of valve actuations.

Male stud acc. to ISO 9974-2 (Type E)
Port acc. to ISO 9974-1

Torque recommendations for Steel mating material.

Male threaded studs were designed for female threaded ports in components made of steel. For applications with components made of softer mating materials (e.g. Aluminium), the use of connectors with additionally rolled male threads is recommended.
Please contact STAUFF prior to the assembly for further information.

Opening pressure tolerance ± 20%.

Ordering Codes

- *FI-RVZA*-10*L*M*-WD*-B*-W3*-1*-MS**
- * Male Stud Check Valve (Flow to Stud End) **FI-RVZA**
- * Outside Tube Diameter D1 (in mm) **-10**
- * Series Light Series **L**
Heavy Series **S**
- * Thread Type Metric Parallel Thread **M**
- If required, please indicate special sizes, e.g. M12x1.5!
- * Seal Type Profile Sealing Ring **-WD**
- * Seal Material NBR (Buna-N®) **-B**
FKM (Viton®) **-V**
- * Material Code Steel, zinc/nickel-plated **-W3**
- Please contact STAUFF for alternative materials and surface finishings.
- * Opening Pressure 1 bar **1**
- Contact STAUFF for alternative opening pressures.
- * Assembling / Kitting Valve body only **—**
Valve body supplied with cutting ring and union nut **-MS**
Valve body supplied with soft-sealing cutting ring and union nut **-MSV**

M

Connecting Parts

- Cutting Ring
Type **FI-DS** Page 28
- Soft-Sealing Cutting Ring
Type **FI-WDDS** Page 29
- Support Sleeve
Type **FI-VH** Page 31
- STAUFF Form EVO Sealing Ring
Type **FI-FD** Page 32
- Union Nut
Type **FI-M** Page 33
- 37° Flared Tube Fitting Set
Type **FI-AB** Page 37

Spare Parts / Accessories

- Profile Sealing Ring
Type **WDG** Page 238



**Female Stud Check Valve
High-Pressure Version
Type FI-RVI-...-R**

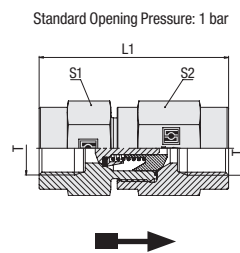

Female Whitworth Parallel Pipe Thread (BSPP)

Ordering Codes

***FI-RVI*-R*1/2*-W3*-1**

- * Female Stud Check Valve **F-RVI**
- * Thread Type Female Whitworth Parallel Pipe Thread (BSPP) **R**
- * Thread Size acc. to dimension table **1/2**
- Please always indicate thread sizes, e.g. 1/2!
- * Material Code Steel, zinc/nickel-plated **-W3**
- Please contact STAUFF for alternative materials and surface finishings.
- * Opening Pressure 1 bar **1**
- Contact STAUFF for alternative opening pressures.

PN bar	Dimensions mm				Weight kg ca. per 100	Ordering Codes
	Thread T	L1	S1	S2		
400	G 1/8	53	22	27	17,72	FI-RVI-R1/8-W3-1
400	G 1/4	63	22	27	18,60	FI-RVI-R1/4-W3-1
400	G 3/8	62	24	27	17,69	FI-RVI-R3/8-W3-1
315	G 1/2	73,5	32	32	34,03	FI-RVI-R1/2-W3-1
250	G 3/4	94,5	41	46	75,00	FI-RVI-R3/4-W3-1
250	G 1	99,5	46	46	84,34	FI-RVI-R1-W3-1
250	G 1 1/4	114,5	60	60	168,10	FI-RVI-R1-1/4-W3-1
250	G 1 1/2	118,5	65	70	210,90	FI-RVI-R1-1/2-W3-1

Please note: Internal seals are made of FKM (Viton®).

Opening pressure tolerance ± 20%.

In order to make sure that the valves will be suitable for your particular application, please contact STAUFF with details on media, operating pressure, pressure peaks, operating temperature and the expected frequency of valve actuations.



Female Stud Check Valve Standard Version Type FI-RVIA-...-R

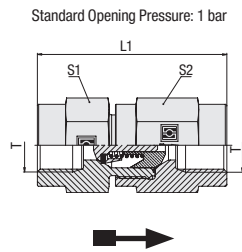

Female Whitworth Parallel Pipe Thread (BSPP)

PB bar	Dimensions mm				Weight kg ca. per 100	Ordering Codes
	Thread T	L1	S1	S2		
250	G 1/8	50,5	19	19	10,4	FI-RVIA-R1/8-W3-1
250	G 1/4	55	19	19	11,7	FI-RVIA-R1/4-W3-1
250	G 3/8	68,5	24	27	21,0	FI-RVIA-R3/8-W3-1
250	G 1/2	74	32	36	35,5	FI-RVIA-R1/2-W3-1
160	G 3/4	84	41	46	80,7	FI-RVIA-R3/4-W3-1
160	G 1	96,5	46	50	89,2	FI-RVIA-R1-W3-1
100	G 1 1/4	110	60	60	189,0	FI-RVIA-R1-1/4-W3-1
100	G 1 1/2	119	65	70	237,6	FI-RVIA-R1-1/2-W3-1

Please note: Internal seals are made of FKM (Viton®).

Opening pressure tolerance $\pm 20\%$.

In order to make sure that the valves will be suitable for your particular application, please contact STAUFF with details on media, operating pressure, pressure peaks, operating temperature and the expected frequency of valve actuations.

Ordering Codes

***FI-RVIA*-R*1/2*-W3*-1**

* Female Stud Check Valve FI-RVIA

* Thread Type Female Whitworth Parallel Pipe Thread (BSPP) R

* Thread Size acc. to dimension table 1/2

Please always indicate thread sizes, e.g. 1/2!

* Material Code Steel, zinc/nickel-plated -W3

Please contact STAUFF for alternative materials and surface finishings.

* Opening Pressure 1 bar 1

Contact STAUFF for alternative opening pressures.



Check Valve Installation Kit Type FI-VES • Design A

Standard Opening Pressure: 1 bar

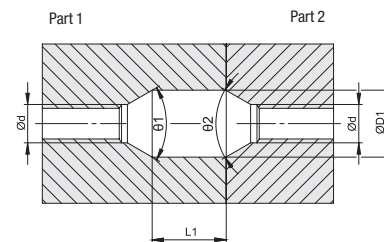
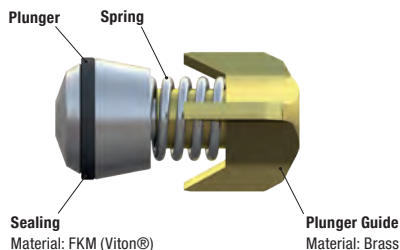

Tube OD mm				Dimensions mm						Ordering Codes
				d	D1	L1	Ø1	Ø2		
6	8	10	12	7,5	13,1	14,5	60	60	FI-VES-NW06-1	
14	15	16	18	11,5	17,6	17	60	60	FI-VES-NW10-1	

Check Valve Installation Kit Type FI-VES • Design B

Standard Opening Pressure: 1 bar

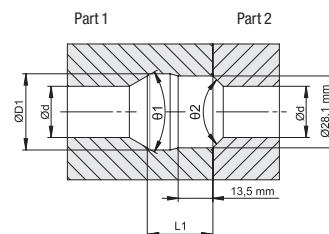
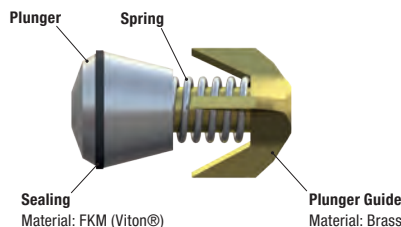
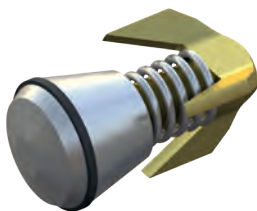

Tube OD mm				Dimensions mm						Ordering Codes
				d	D1	L1	Ø1	Ø2		
20	22	25	28	20	29,8	25,7	60	90	FI-VES-NW16-1	

Check Valve Installation Kit Type FI-VES • Design C

Standard Opening Pressure: 1 bar

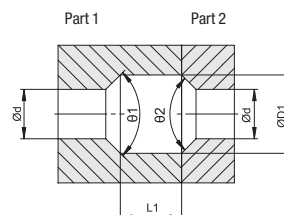
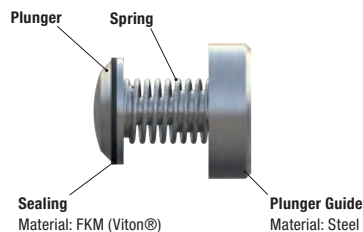

Tube OD mm				Dimensions mm						Ordering Codes
				d	D1	L1	Ø1	Ø2		
30				24	38	33	90	90	FI-VES-NW25-1	
35	38	42		29	46	36	90	90	FI-VES-NW32-1	

M



Alternating Valve Type FI-WV • Series L / S

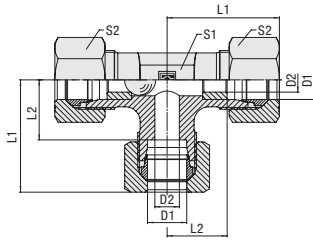

Flow Directions:
A > C (B closed) or B > C (A closed)

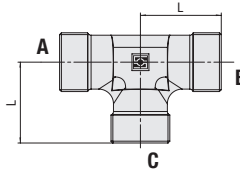

Recommended Installation Position



Series	Tube OD		PB	Dimensions				Weight kg ca. per 100	Ordering Codes ³	
	mm	bar		mm	L	L1 ¹	L2			S1
L	8	250	4	21	29	14	14	17	5,50	FI-WV-08L-W3
	10	250	6	22	30	15	17	19	7,30	FI-WV-10L-W3
	12	250	8	24	32	17	19	22	10,27	FI-WV-12L-W3
	15	250	9	28	36	21	19	27	10,95	FI-WV-15L-W3
S	6	630	4	23	31	16	14	17	7,04	FI-WV-06S-W3
	8	630	4	24	32	17	17	19	9,49	FI-WV-08S-W3
	10	630	6	25	34	17,5	19	22	12,41	FI-WV-10S-W3
	12	630	8	29	38	21,5	22	24	17,10	FI-WV-12S-W3
	16	400	10	33	43	24,5	24	30	19,60	FI-WV-16S-W3

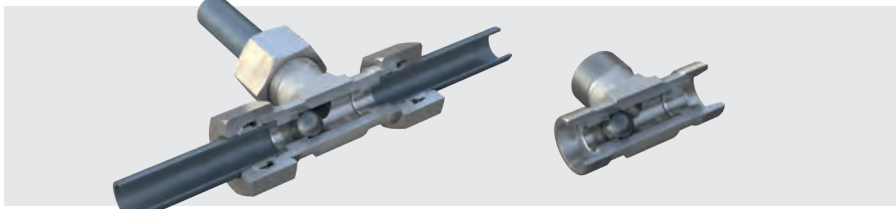

¹ Approx.imate dimension in assembled condition.
² Weight excluding cutting rings and union nuts.
³ Standard scope of delivery: Valve body only.

In order to make sure that the valves will be suitable for your particular application, please contact STAUFF with details on media, operating pressure, pressure peaks, operating temperature and the expected frequency of valve actuations.

Do not use with compressed air or gas!

Spillage: 1-1,5cm³/min at Pmax

Please note: Alternating valves have been designed as switching devices for hydraulic fluids, where the non-pressurized connection of the valve is automatically closed off and sealed by a moving ball made of steel.

Alternating valves are only suitable for connections that fit directly against the tube end stop of the valve body. Do not use in combination with 24° weld cone fittings, 24° DKO taper fittings and other types of fittings with no direct contact to the tube end stop of the valve body.

Ordering Codes

***FI-WV*-10*L*-W3*-MS**

* Alternating Valve		FI-WV
* Outside Tube Diameter D1 (in mm)		-10
* Series	Light Series	L
	Heavy Series	S
* Material Code	Steel, zinc/nickel-plated	-W3
Please contact STAUFF for alternative materials and surface finishings.		
* Assembling / Kitting	Valve body only	—
	Valve body supplied with cutting rings and union nuts	-MS
	Valve body supplied with soft-sealing cutting rings and union nuts	-MSV

Connecting Parts

	Cutting Ring Type FI-DS	Page 28
	Soft-Sealing Cutting Ring Type FI-WDDS	Page 29
	Support Sleeve Type FI-VH	Page 31
	STAUFF Form EVO Sealing Ring Type FI-FD	Page 32
	Union Nut Type FI-M	Page 33
	37° Flared Tube Fitting Set Type FI-AB	Page 37



Maximum opening pressure for Hydraulic Valves

Series	Tube OD	max. opening pressure (FI-RVA, FI-RVVA, FI-RVZA, FI-RVIA)	max. opening pressure (FI-RV, FI-RVV, FI-RVZ, FI-RVI)
	mm	Standard Version bar	High-Pressure Version bar
L	6	6	3
	8	6	3
	10	6	3
	12	6	3
	15	6	3
	18	6	3
	22	6	3
	28	6	3
	35	5	3
	42	2	3
	S	6	6
8		6	3
10		6	3
12		6	3
14		6	3
16		6	3
20		6	3
25		6	3
30		6	3
38		5	3



Pressure Loss Graphs for Check Valves
High-Pressure Version
Type FI-RV • Series L / S

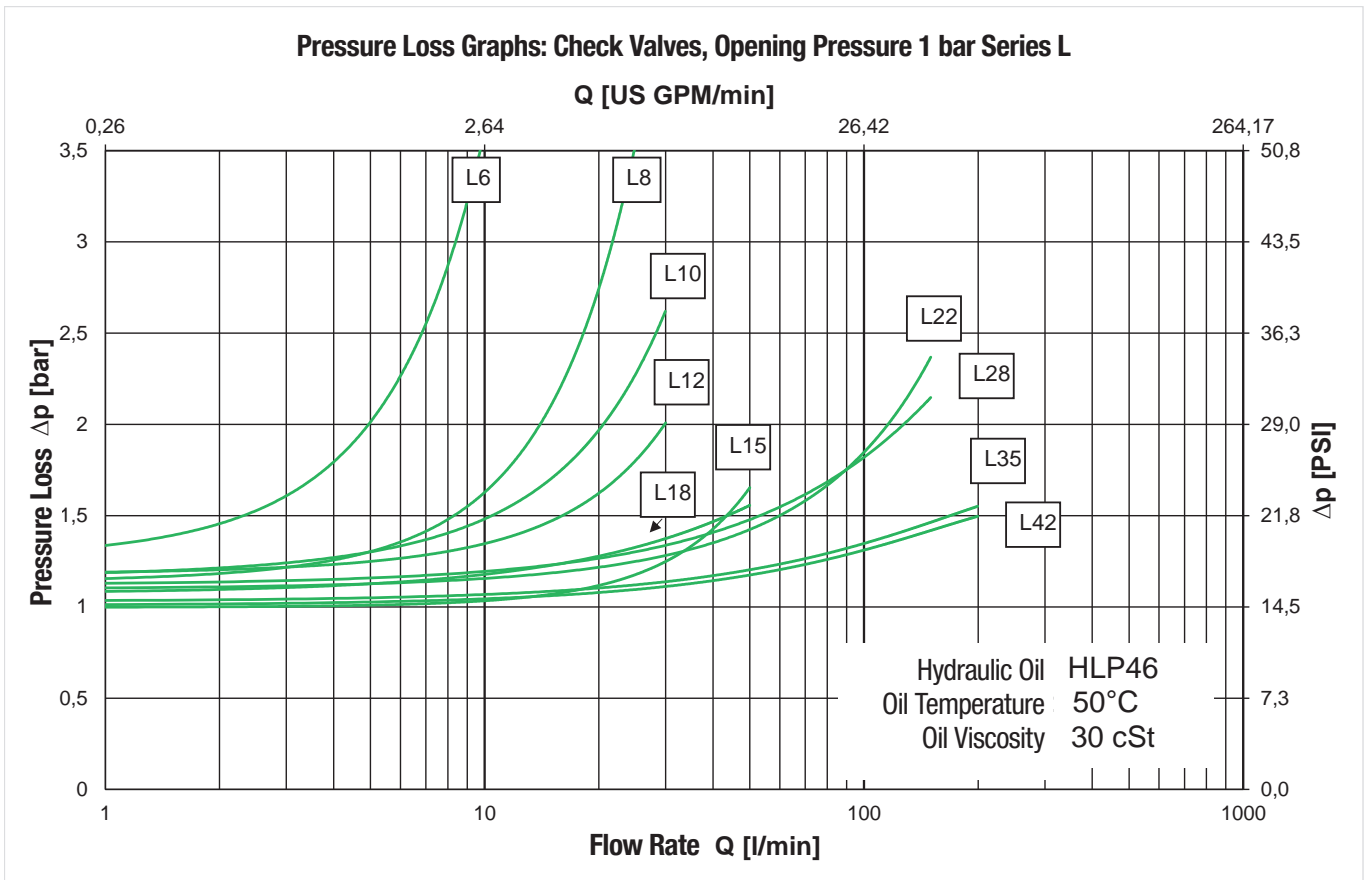

M

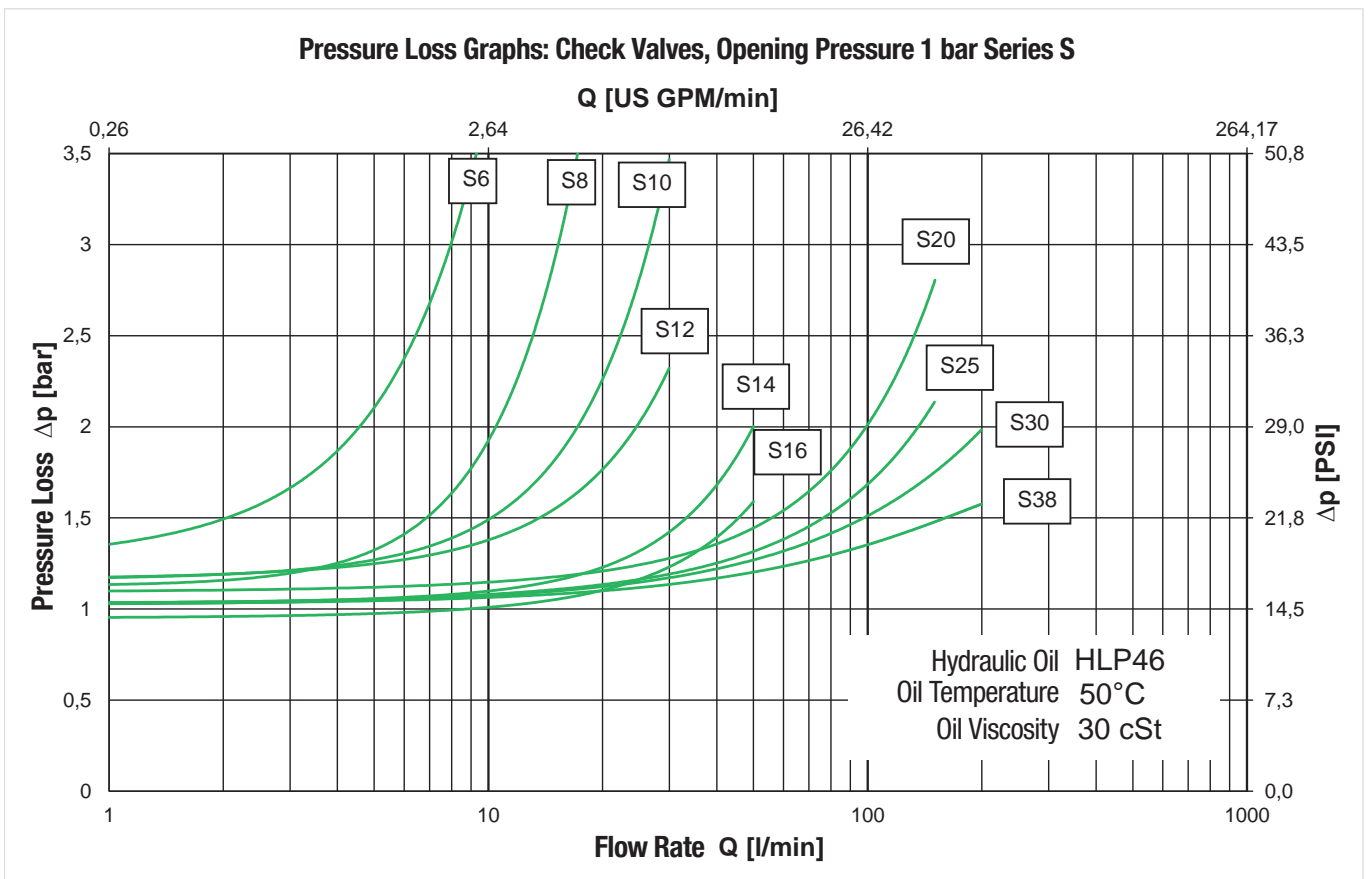

Pressure Loss Graphs for Check Valves
Standard Version
Type FI-RVA • Series L / S

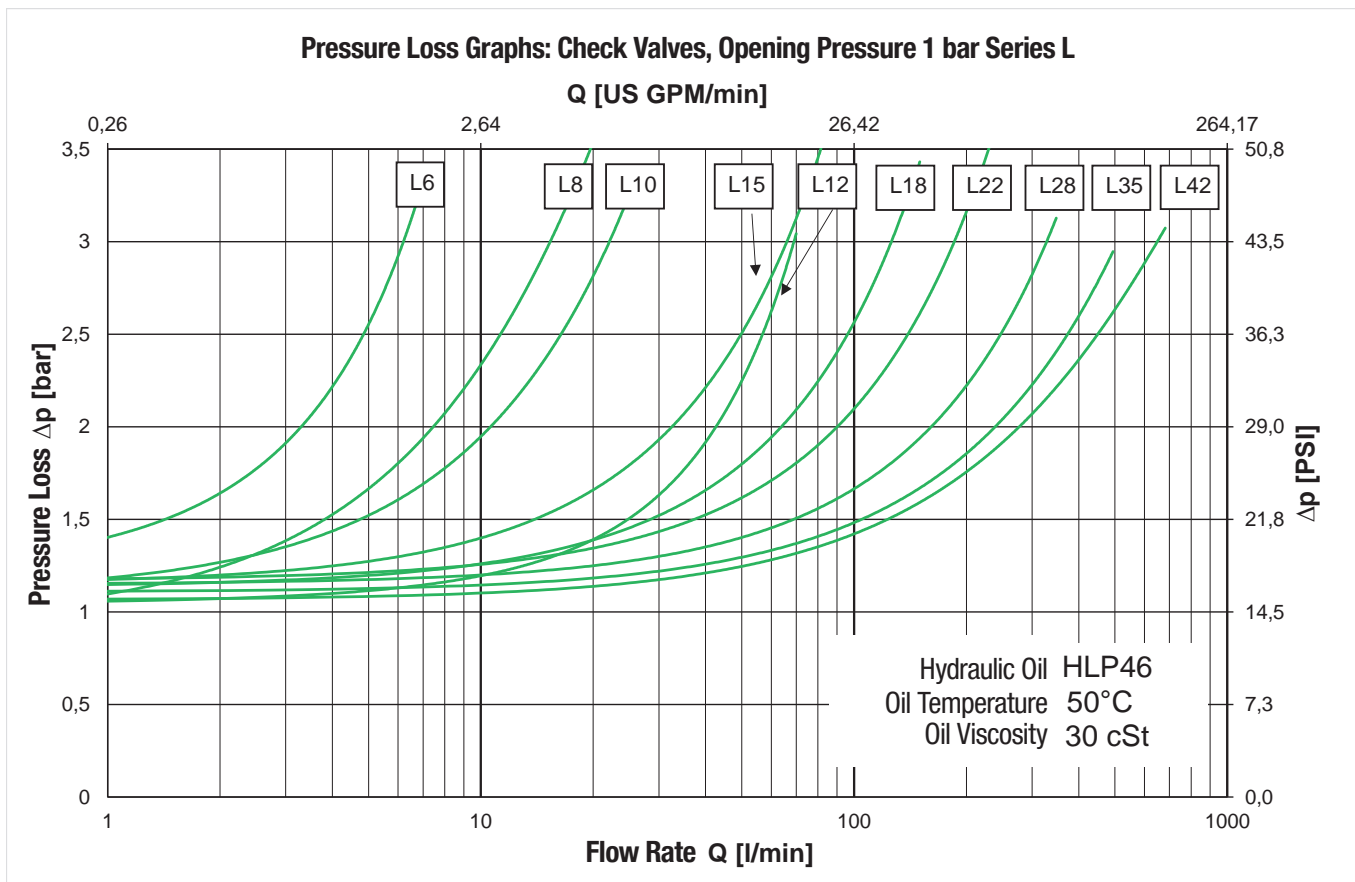

M

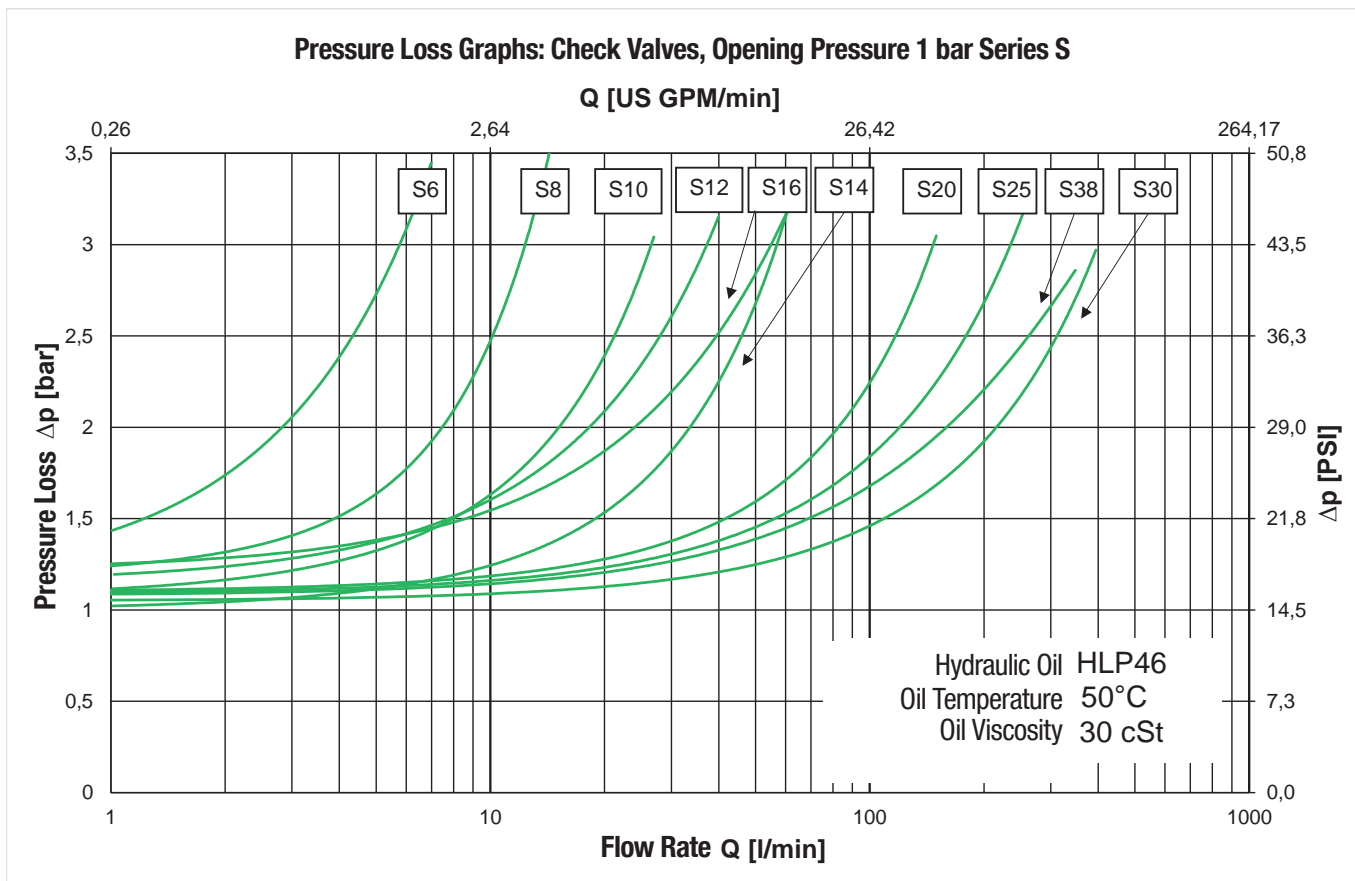

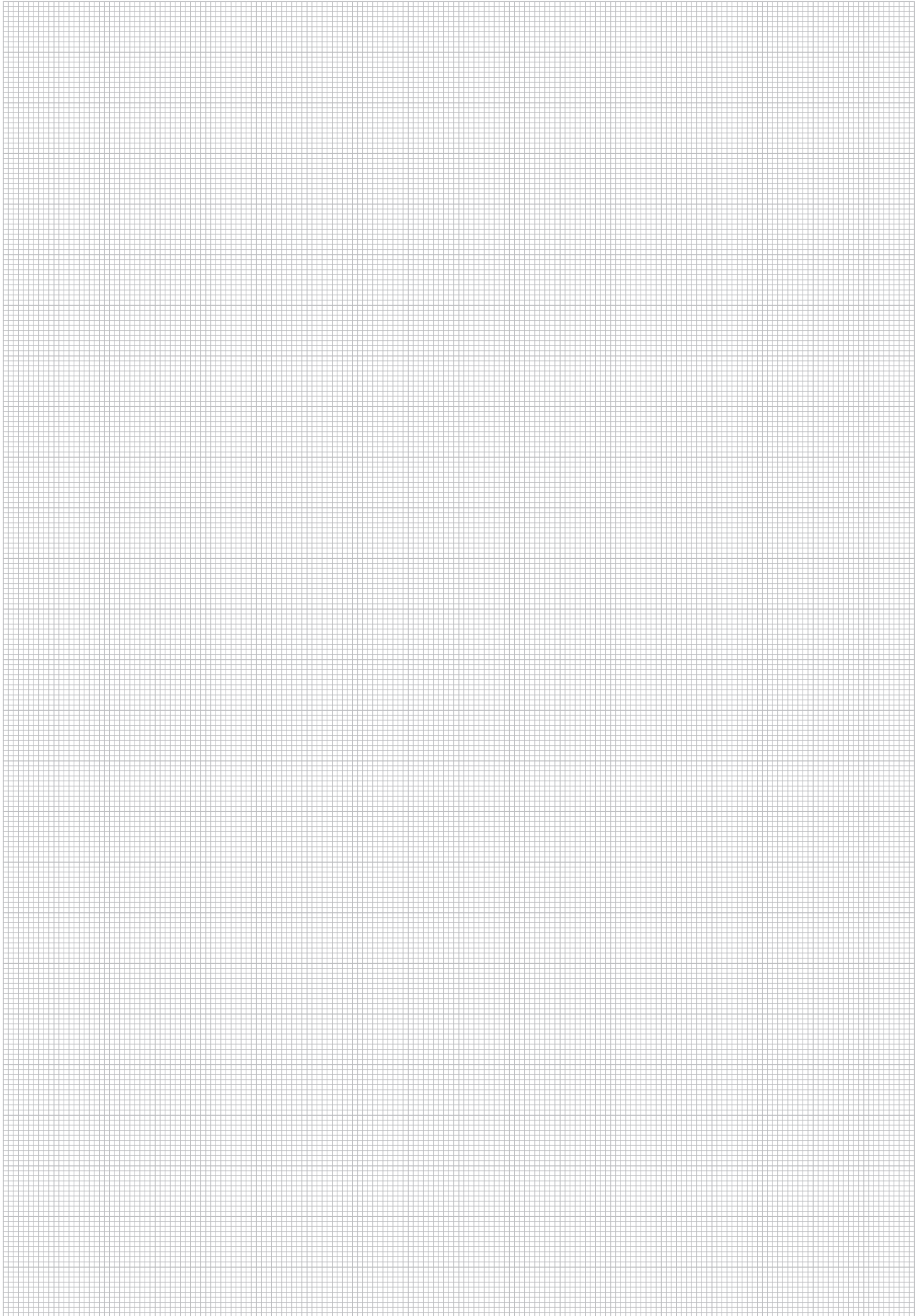

M



Kommissionier-Shuttle WALTER II



**Custom-Designed Solutions**

220

In addition to a complete range of standard components, STAUFF is also able offer individually designed special solutions according to customer's specifications or based on own developments.

Options include tube connectors with non-standard connection types and combinations, in special lengths and jump sizes or with throttle bores as well as distributors and manifolds in single-piece, soldered, brazed and welded construction.

Please do not hesitate to contact STAUFF for further information.





N



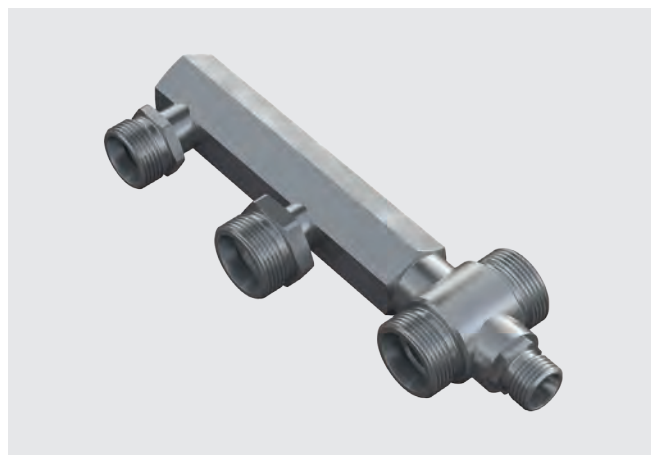
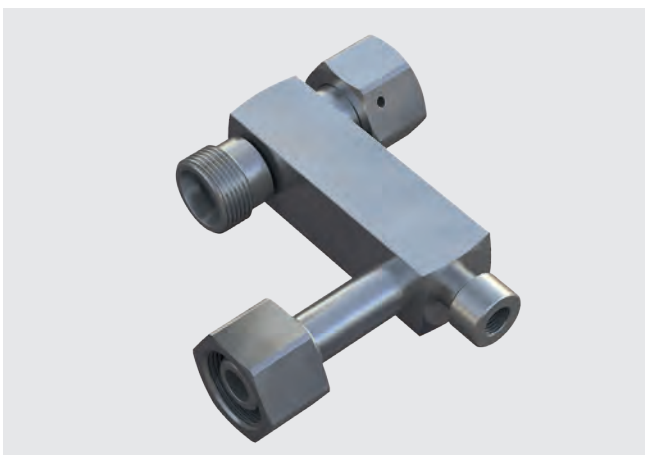



















N





	Thread Reducer FI-RED	224-226		Profile Sealing Ring WDG	238
	Whitworth Parallel Pipe Thread (BSPP) / Profile Sealing Ring FI-RED-...-R-WD	224		O-Ring O-RING	239
	Whitworth Parallel Pipe Thread (BSPP) / Metallic Sealing Edge FI-RED-...-R	226		External Metallic Sealing Ring FI-DKR	244
	Blanking Screw for Ports (Heavy Duty) FI-VSV	228-229		Retaining Ring with Captive Seal FI-DIR	245
	Whitworth Parallel Pipe Thread (BSPP) / Profile Sealing Ring FI-VSV-...-R-WD	228		Internal Metallic Sealing Ring FI-DKI	246
	Metric Parallel Thread / Profile Sealing Ring FI-VSV-...-M-WD	229		Retaining Ring (Small) FI-KR	247
	Blanking Screw for Ports FI-VS	230-233			
	Whitworth Parallel Pipe Thread (BSPP) / Profile Sealing Ring FI-VS-...-R-WD	230			
	Metric Parallel Thread / Profile Sealing Ring FI-VS-...-M-WD	231			
	Whitworth Parallel Pipe Thread (BSPP) / Metallic Sealing Edge FI-VS-...-R	232			
	Metric Parallel Thread / O-Ring FI-VS-...-M-OR	233			
	Blanking Plug with 24° Taper / O-Ring (DK0) FI-VD	234			
	Blanking Plug with Sealing Edge FI-BUZ	235			
	Blanking Plug for Tube Ends FI-VSK	236			
	Hexagon Lock Nut FI-SKM	237			



Thread Reducer Type FI-RED-...-R-WD

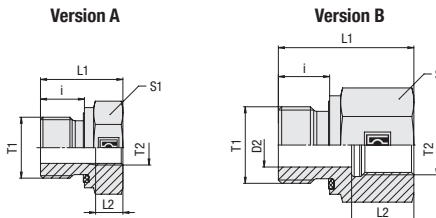

Male / Female Whitworth Parallel Pipe Thread (BSPP)

Profile Sealing Ring

Ordering Codes

***FI-RED*-R*1/2*-WD*-R*3/8*-B*-W3**

- * Thread Reducer **FI-RED**
- * Thread Type T1 Whitworth Parallel Pipe Thread (BSPP) **R**
- * Thread Size T1 acc. to dimension table **1/2**
- Please always indicate thread sizes, e.g. 1/2!
- * Seal Type Profile Sealing Ring **-WD**
- * Thread Type T2 Whitworth Parallel Pipe Thread (BSPP) **R**
- * Thread Size T2 acc. to dimension table **3/8**
- Please always indicate thread sizes, e.g. 3/8!
- * Seal Material NBR (Buna-N®) **-B**
FKM (Viton®) **-V**
- * Material Code Steel, zinc/nickel-plated **-W3**

Please contact STAUFF for alternative materials and surface finishings.

PN bar	Dimensions mm								Version	Torque N-m	Weight kg ca. per 100	Ordering Codes
	Thread T1	Thread T2	D2	i	L1	L2	S1	Thread T				
630	G 1/8	G 1/4	4	8	31	17	19	B	25	4,30	FI-RED-R1/8-WD-R1/4-B-W3	
630	G 1/8	G 3/8	4	8	32	17	24	B	25	6,70	FI-RED-R1/8-WD-R3/8-B-W3	
630	G 1/4	G 1/8	5	12	29	12	19	B	55	4,40	FI-RED-R1/4-WD-R1/8-B-W3	
630	G 1/4	G 1/4	8	12	35,5	17	22	B	55	4,26	FI-RED-R1/4-WD-R1/4-B-W3	
630	G 1/4	G 3/8	5	12	36	17	24	B	55	7,30	FI-RED-R1/4-WD-R3/8-B-W3	
630	G 1/4	G 1/2	5	12	40	20	30	B	55	12,80	FI-RED-R1/4-WD-R1/2-B-W3	
630	G 1/4	G 3/4	5	12	43	22	36	B	55	18,80	FI-RED-R1/4-WD-R3/4-B-W3	
630	G 3/8	G 1/8	12	22,5	8,5	22	A	80	4,20	FI-RED-R3/8-WD-R1/8-B-W3		
630	G 3/8	G 1/4	8	12	36	17	22	B	80	7,40	FI-RED-R3/8-WD-R1/4-B-W3	
630	G 3/8	G 1/2	8	12	41	20	30	B	80	13,60	FI-RED-R3/8-WD-R1/2-B-W3	
400	G 3/8	G 3/4	8	12	44	22	36	B	80	19,70	FI-RED-R3/8-WD-R3/4-B-W3	
630	G 1/2	G 1/8	14	24	8	27	A	115	7,00	FI-RED-R1/2-WD-R1/8-B-W3		
630	G 1/2	G 1/4	14	24	12	27	A	115	6,20	FI-RED-R1/2-WD-R1/4-B-W3		
630	G 1/2	G 3/8	12	14	37	17	27	B	115	10,40	FI-RED-R1/2-WD-R3/8-B-W3	
630	G 1/2	G 1/2	12	14	43	20	30	B	115	13,11	FI-RED-R1/2-WD-R1/2-B-W3	
400	G 1/2	G 3/4	12	14	46	22	36	B	115	20,10	FI-RED-R1/2-WD-R3/4-B-W3	
400	G 1/2	G 1	12	14	49	24,5	41	B	115	25,10	FI-RED-R1/2-WD-R1-B-W3	
250	G 1/2	G 1 1/4	10	14	53	26,5	55	B	115	52,10	FI-RED-R1/2-WD-R1-1/4-B-W3	

Standard seal material is NBR (Buna-N®).

Male threaded studs were designed for female threaded ports in components made of steel. For applications with components made of softer mating materials (e.g. Aluminium), the use of connectors with additionally rolled male threads is recommended.

Please contact STAUFF prior to the assembly for further information.

Spare Parts / Accessories



Profile Sealing Ring
Type **WDG**

Page 238



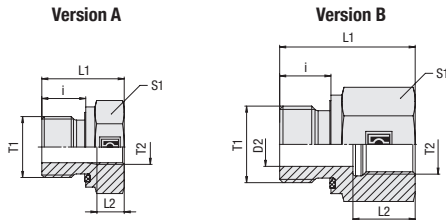

**Thread Reducer
Type FI-RED-...-R-WD**



Profile Sealing Ring

Male / Female Whitworth Parallel Pipe Thread (BSPP)

PN bar	Dimensions mm							Version	Torque N-m	Weight kg ca. per 100	Ordering Codes
	Thread T1	Thread T2	D2	i	L1	L2	S1				
400	G 3/4	G 1/4		16	26	12,5	32	A	180	10,90	FI-RED-R3/4-WD-R1/4-B-W3
400	G 3/4	G 3/8		16	26	12,5	32	A	180	9,40	FI-RED-R3/4-WD-R3/8-B-W3
400	G 3/4	G 1/2	16	16	43	20	32	B	180	16,90	FI-RED-R3/4-WD-R1/2-B-W3
400	G 3/4	G 3/4	16	16	48	22	41	B	180	18,96	FI-RED-R3/4-WD-R3/4-B-W3
400	G 3/4	G 1	16	16	51	24,5	41	B	180	26,60	FI-RED-R3/4-WD-R1-B-W3
250	G 3/4	G 1 1/4	16	16	55	26,5	55	B	180	52,70	FI-RED-R3/4-WD-R1-1/4-B-W3
250	G 3/4	G 1 1/2	16	16	57	28,5	60	B	180	61,10	FI-RED-R3/4-WD-R1-1/2-B-W3
400	G 1	G 1/4		18	29	12,5	41	A	310	20,70	FI-RED-R1-WD-R1/4-B-W3
400	G 1	G 3/8		18	29	12,5	41	A	310	19,10	FI-RED-R1-WD-R3/8-B-W3
400	G 1	G 1/2		18	29	14,5	41	A	310	16,80	FI-RED-R1-WD-R1/2-B-W3
400	G 1	G 3/4	20	18	49	22	41	B	310	31,30	FI-RED-R1-WD-R3/4-B-W3
400	G 1	G 1	20	18	52	24,5	41	B	310	26,21	FI-RED-R1-WD-R1-B-W3
250	G 1	G 1 1/4	20	18	57	26,5	55	B	310	58,80	FI-RED-R1-WD-R1-1/4-B-W3
250	G 1	G 1 1/2	20	18	59	28,5	60	B	310	63,90	FI-RED-R1-WD-R1-1/2-B-W3
400	G 1 1/4	G 1/2		20	32	14,5	50	A	450	33,00	FI-RED-R1-1/4-WD-R1/2-B-W3
400	G 1 1/4	G 3/4		20	32	16,5	50	A	450	28,30	FI-RED-R1-1/4-WD-R3/4-B-W3
400	G 1 1/4	G 1	25	20	53	24,5	50	B	450	50,60	FI-RED-R1-1/4-WD-R1-B-W3
250	G 1 1/4	G 1 1/2	25	20	60	28,5	60	B	450	67,30	FI-RED-R1-1/4-WD-R1-1/2-B-W3
400	G 1 1/2	G 1/2		22	36	14,5	55	A	540	49,60	FI-RED-R1-1/2-WD-R1/2-B-W3
400	G 1 1/2	G 3/4		22	36	16	55	A	540	44,40	FI-RED-R1-1/2-WD-R3/4-B-W3
400	G 1 1/2	G 1		22	36	18,5	55	A	540	36,90	FI-RED-R1-1/2-WD-R1-B-W3
250	G 1 1/2	G 1 1/4		22	58	26,5	55	B	540	57,80	FI-RED-R1-1/2-WD-R1-1/4-B-W3
160	G 2	G 1		24	46	19,5	75	A	700	99,8	FI-RED-R2-WD-R1-B-W3
160	G 2	G 1 1/4		24	48	20,5	75	A	700	93,70	FI-RED-R2-WD-R1-1/4-B-W3
160	G 2	G 1 1/2	40	24	65	29	75	B	700	132,20	FI-RED-R2-WD-R1-1/2-B-W3

Ordering Codes

***FI-RED*-R*1/2*-WD*-R*3/8*-B*-W3**

- * Thread Reducer FI-RED
- * Thread Type T1 Whitworth Parallel Pipe Thread (BSPP) R
- * Thread Size T1 acc. to dimension table 1/2
- Please always indicate thread sizes, e.g. 1/2!
- * Seal Type Profile Sealing Ring -WD
- * Thread Type T2 Whitworth Parallel Pipe Thread (BSPP) R
- * Thread Size T2 acc. to dimension table 3/8
- Please always indicate thread sizes, e.g. 3/8!
- * Seal Material NBR (Buna-N®) -B
FKM (Viton®) -V
- * Material Code Steel, zinc/nickel-plated -W3

Please contact STAUFF for alternative materials and surface finishings.

Standard seal material is NBR (Buna-N®).

Male threaded studs were designed for female threaded ports in components made of steel. For applications with components made of softer mating materials (e.g. Aluminium), the use of connectors with additionally rolled male threads is recommended. Please contact STAUFF prior to the assembly for further information.

Spare Parts / Accessories



Profile Sealing Ring
Type **WDG**

Page 238



**Thread Reducer
Type FI-RED-...-R**

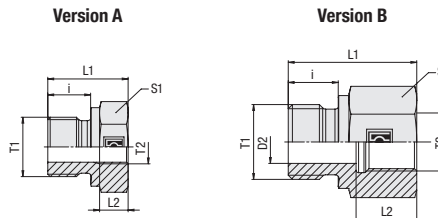

Male / Female Whitworth Parallel Pipe Thread (BSPP)

Metallic Sealing Edge

Ordering Codes

***FI-RED*-R*1/2*-R*3/8*-B*-W3**

- * Thread Reducer **FI-RED**
- * Thread Type T1 **R**
Whitworth Parallel Pipe Thread (BSPP)
- * Thread Size T1 **1/2**
acc. to dimension table
Please always indicate thread sizes, e.g. 1/2!
- * Thread Type T2 **R**
Whitworth Parallel Pipe Thread (BSPP)
- * Thread Size T2 **3/8**
acc. to dimension table
Please always indicate thread sizes, e.g. 3/8!
- * Seal Material **-B**
NBR (Buna-N®)
-V FKM (Viton®)
- * Material Code **-W3**
Steel, zinc/nickel-plated

Please contact STAUFF for alternative materials and surface finishings.

PN bar	Dimensions mm								Version	Torque N-m	Weight kg ca. per 100	Ordering Codes
	Thread T1	Thread T2	D2	i	L1	L2	S1					
400	G 1/8	G 1/4	4	8	31	17	19	B	25	4,25	FI-RED-R1/8-R1/4-W3	
400	G 1/8	G 3/8	4	8	32	17	24	B	25	6,15	FI-RED-R1/8-R3/8-W3	
400	G 1/4	G 1/8	5	12	28	12	19	B	60	3,91	FI-RED-R1/4-R1/8-W3	
400	G 1/4	G 3/8	5	12	36	17	24	B	60	6,80	FI-RED-R1/4-R3/8-W3	
400	G 1/4	G 1/2	5	12	40	20	30	B	60	11,80	FI-RED-R1/4-R1/2-W3	
315	G 1/4	G 3/4	5	12	43	22	36	B	60	17,50	FI-RED-R1/4-R3/4-W3	
400	G 3/8	G 1/8	8	12	22,5	8	22	A	110	4,20	FI-RED-R3/8-R1/8-W3	
400	G 3/8	G 1/4	8	12	36	17	22	B	110	7,05	FI-RED-R3/8-R1/4-W3	
400	G 3/8	G 1/2	8	12	41	20	30	B	110	17,80	FI-RED-R3/8-R1/2-W3	
315	G 3/8	G 3/4	8	12	44	22	36	B	110	18,40	FI-RED-R3/8-R3/4-W3	
400	G 1/2	G 1/8	14	14	24	8	27	A	200	6,58	FI-RED-R1/2-R1/8-W3	
315	G 1/2	G 1/4	14	14	24	12,5	27	A	200	5,53	FI-RED-R1/2-R1/4-W3	
315	G 1/2	G 3/8	12	14	36	17	27	B	200	9,30	FI-RED-R1/2-R3/8-W3	
315	G 1/2	G 3/4	12	14	46	22	36	B	200	18,50	FI-RED-R1/2-R3/4-W3	
315	G 1/2	G 1	12	14	49	24,5	41	B	200	22,70	FI-RED-R1/2-R1-W3	
160	G 1/2	G 1 1/4	12	14	53	26,5	55	B	200	48,10	FI-RED-R1/2-R1-1/4-W3	

Male threaded studs were designed for female threaded ports in components made of steel. For applications with components made of softer mating materials (e.g. Aluminium), the use of connectors with additionally rolled male threads is recommended.

Please contact STAUFF prior to the assembly for further information.



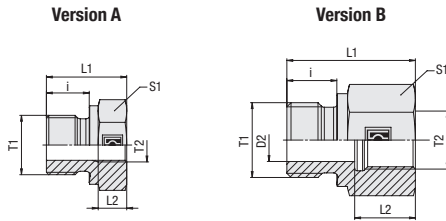

Thread Reducer Type FI-RED-...-R



Metallic Sealing Edge

Male / Female Whitworth Parallel Pipe Thread (BSPP)

PN bar	Dimensions mm								Version	Torque N-m	Weight kg ca. per 100	Ordering Codes
	Thread T1	Thread T2	D2	i	L1	L2	S1	Thread T				
400	G 3/4	G 1/4		16	26	12,5	32	A	320	10,20	FI-RED-R3/4-R1/4-W3	
400	G 3/4	G 3/8		16	26	12,5	32	A	320	8,70	FI-RED-R3/4-R3/8-W3	
400	G 3/4	G 1/2	16	16	41	20	32	B	320	14,60	FI-RED-R3/4-R1/2-W3	
400	G 3/4	G 1	16	16	51	24,5	41	B	320	24,60	FI-RED-R3/4-R1-W3	
400	G 3/4	G 1 1/4	16	16	55	26,5	55	B	320	48,40	FI-RED-R3/4-R1-1/4-W3	
250	G 3/4	G 1 1/2	16	16	57	28,5	60	B	320	57,00	FI-RED-R3/4-R1-1/2-W3	
315	G 1	G 1/4		18	29	12,5	41	A	500	19,10	FI-RED-R1-R1/4-W3	
315	G 1	G 3/8		18	29	12,5	41	A	500	17,90	FI-RED-R1-R3/8-W3	
315	G 1	G 1/2		18	29	14,5	41	A	500	15,40	FI-RED-R1-R1/2-W3	
315	G 1	G 3/4	20	18	47	22	41	B	500	27,60	FI-RED-R1-R3/4-W3	
160	G 1	G 1 1/4	20	18	57	26,5	55	B	500	52,10	FI-RED-R1-R1-1/4-W3	
160	G 1	G 1 1/2	20	18	59	28,5	60	B	500	59	FI-RED-R1-R1-1/2-W3	
160	G 1 1/4	G 1/2		20	32	14,5	50	A	600	31,30	FI-RED-R1-1/4-R1/2-W3	
160	G 1 1/4	G 3/4		20	32	16,5	50	A	600	26,50	FI-RED-R1-1/4-R3/4-W3	
160	G 1 1/4	G 1	25	20	53	24,5	50	B	600	4,7	FI-RED-R1-1/4-R1-W3	
160	G 1 1/4	G 1 1/2	25	20	60	28,5	60	B	600	63,3	FI-RED-R1-1/4-R1-1/2-W3	
160	G 1 1/2	G 1 1/4	32	22	58	26,5	55	B	800	53	FI-RED-R1-1/2-R1-1/4-W3	
160	G 1 1/2	G 1/2		22	36	14,5	55	A	800	47,30	FI-RED-R1-1/2-R1/2-W3	
160	G 1 1/2	G 3/4		22	36	14,5	55	A	800	41,90	FI-RED-R1-1/2-R3/4-W3	
160	G 1 1/2	G 1		22	36	18	55	A	800	34,10	FI-RED-R1-1/2-R1-W3	
160	G 2	G 1 1/4		24	62	20,5	70	A	1000	99,50	FI-RED-R2-R1-1/4-W3	
160	G 2	G 1 1/2	40	24	62	28,5	70	B	1000	107,30	FI-RED-R2-R1-1/2-W3	

Ordering Codes

FI-RED-R*1/2*-R*3/8*-B*-W3

* Thread Reducer		FI-RED
* Thread Type T1	Whitworth Parallel Pipe Thread (BSPP)	R
* Thread Size T1	acc. to dimension table	1/2
Please always indicate thread sizes, e.g. 1/2!		
* Thread Type T2	Whitworth Parallel Pipe Thread (BSPP)	R
* Thread Size T2	acc. to dimension table	3/8
Please always indicate thread sizes, e.g. 3/8!		
* Seal Material	NBR (Buna-N®) FKM (Viton®)	-B -V
* Material Code	Steel, zinc/nickel-plated	-W3

Please contact STAUFF for alternative materials and surface finishings.

Male threaded studs were designed for female threaded ports in components made of steel. For applications with components made of softer mating materials (e.g. Aluminium), the use of connectors with additionally rolled male threads is recommended.

Please contact STAUFF prior to the assembly for further information.



Blanking Screw for Ports (Heavy Duty) Type FI-VSV-...-R-WD

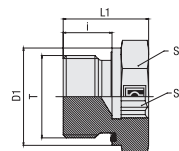

Ordering Codes

FI-VSV-R*1/2*-WD*-B*-W3

* Blanking Screw for Ports		FI-VSV
* Thread Type	Whitworth Parallel Pipe Thread (BSPP)	R
* Thread Size	acc. to dimension table	1/2
Please always indicate thread sizes, e.g. 1/2!		
* Seal Type	Profile Sealing Ring	-WD
* Seal Material	NBR (Buna-N®) FKM (Viton®)	-B -V
* Material Code	Steel, zinc/nickel-plated	-W3

Please contact STAUFF for alternative materials and surface finishings.

Spare Parts / Accessories



Profile Sealing Ring
Type **WDG**

Page 238

Whitworth Parallel Pipe Thread (BSPP)

Profile Sealing Ring

PN bar	Dimensions mm						Torque N·m Thread T	Weight kg ca. per 100	Ordering Codes
	Thread T	D1	i	L1	S1	S2			
400	G 1/8	14	8	18	5	14	18	1,56	FI-VSV-R1/8-WD-B-W3
400	G 1/4	19	12	20	6	19	33	2,73	FI-VSV-R1/4-WD-B-W3
400	G 3/8	22	12	22	8	22	70	4,48	FI-VSV-R3/8-WD-B-W3
400	G 1/2	27	14	24	10	27	90	7,27	FI-VSV-R1/2-WD-B-W3
400	G 3/4	32	16	28	12	32	181	13,02	FI-VSV-R3/4-WD-B-W3
400	G 1	39,9	18	33	17	41	250	23,80	FI-VSV-R1-WD-B-W3
400	G 1 1/4	49,9	20	38	22	50	400	42,00	FI-VSV-R1-1/4-WD-B-W3
400	G 1 1/2	54,9	22	40	24	55	500	55,60	FI-VSV-R1-1/2-WD-B-W3

Standard seal material is NBR (Buna-N®).

Male threaded studs were designed for female threaded ports in components made of steel. For applications with components made of softer mating materials (e.g. Aluminium), the use of connectors with additionally rolled male threads is recommended.

Please contact STAUFF prior to the assembly for further information.

Male stud acc. to ISO 1179-2 (Type E)
Port acc. to ISO 1179-1

Torque recommendations with a tolerance of +10% and refer to original components from the STAUFF Connect product range made of steel with zinc/nickel coating and apply for Steel mating material.



Blanking Screw for Ports (Heavy Duty) Type FI-VSV-...-M-WD

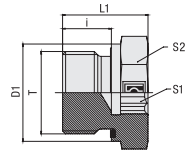

Profile Sealing Ring

Metric Parallel Thread

PN bar	Dimensions mm						Torque N-m	Weight kg ca. per 100	Ordering Codes
	Thread T	D1	i	L1	S1	S2			
400	M 10 x 1	14	8	18	5	14	12	1,58	FI-VSV-M10x1-WD-B-W3
400	M 12 x 1,5	17	12	20	6	17	25	2,13	FI-VSV-M12x1.5-WD-B-W3
400	M 14 x 1,5	19	12	22	6	19	45	3,35	FI-VSV-M14x1.5-WD-B-W3
400	M 16 x 1,5	22	12	22	8	22	55	4,30	FI-VSV-M16x1.5-WD-B-W3
400	M 18 x 1,5	24	12	22	8	24	70	5,38	FI-VSV-M18x1.5-WD-B-W3
400	M 20 x 1,5	27	14	22	10	27	80	6,09	FI-VSV-M20x1.5-WD-B-W3
400	M 22 x 1,5	27	14	22	10	27	125	6,77	FI-VSV-M22x1.5-WD-B-W3
400	M 26 x 1,5	32	16	30	12	32	180	14,33	FI-VSV-M26x1.5-WD-B-W3
400	M 27 x 2	32	16	28	12	32	180	13,23	FI-VSV-M27x2-WD-B-W3
400	M 33 x 2	40	18	33	17	41	250	29,32	FI-VSV-M33x2-WD-B-W3
400	M 42 x 2	50	20	38	22	50	400	57,35	FI-VSV-M42x2-WD-B-W3
400	M 48 x 2	55	22	40	24	55	500	73,79	FI-VSV-M48x2-WD-B-W3

Standard seal material is NBR (Buna-N®).

Male threaded studs were designed for female threaded ports in components made of steel. For applications with components made of softer mating materials (e.g. Aluminium), the use of connectors with additionally rolled male threads is recommended.

Please contact STAUFF prior to the assembly for further information.

Male stud acc. to ISO 9974-2 (Type E)
Port acc. to ISO 9974-1

Torque recommendations with a tolerance of +10% and refer to original components from the STAUFF Connect product range made of steel with zinc/nickel coating and apply for Steel mating material.

Ordering Codes

FI-VSV-M*12x1.5*-WD*-B*-W3

* Blanking Screw for Ports		FI-VSV
* Thread Type	Metric Parallel Thread	M
* Thread Size	acc. to dimension table	12x1.5
Please always indicate thread sizes, e.g. 12x1.5!		
* Seal Type	Profile Sealing Ring	-WD
* Seal Material	NBR (Buna-N®) FKM (Viton®)	-B -V
* Material Code	Steel, zinc/nickel-plated	-W3

Please contact STAUFF for alternative materials and surface finishings.

Spare Parts / Accessories



Profile Sealing Ring
Type WDG

Page 238



Blanking Screw for Ports Type FI-VS-...-R-WD

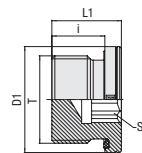

Ordering Codes

FI-VS-R*1/2*-WD*-B*-W3

* Blanking Screw for Ports		FI-VS
* Thread Type	Whitworth Parallel Pipe Thread (BSPP)	R
* Thread Size	acc. to dimension table	1/2
Please always indicate thread sizes, e.g. 1/2!		
* Seal Type	Profile Sealing Ring	-WD
* Seal Material	NBR (Buna-N®) FKM (Viton®)	-B -V
* Material Code	Steel, zinc/nickel-plated	-W3

Please contact STAUFF for alternative materials and surface finishings.

Spare Parts / Accessories



Profile Sealing Ring
Type **WDG**

Page 238

Whitworth Parallel Pipe Thread (BSPP)

Profile Sealing Ring

PN bar	Dimensions mm					Torque N-m Thread T	Weight kg ca. per 100	Ordering Codes
	Thread T	D1	i	L1	S1			
400	G 1/8	14	8	12,3	5	15	0,70	FI-VS-R1/8-WD-B-W3
400	G 1/4	19	12	17,3	6	25	1,90	FI-VS-R1/4-WD-B-W3
400	G 3/8	22	12	17,3	8	50	2,70	FI-VS-R3/8-WD-B-W3
400	G 1/2	27	14	19,3	10	70	4,60	FI-VS-R1/2-WD-B-W3
400	G 3/4	32	16	21,3	12	120	8,00	FI-VS-R3/4-WD-B-W3
400	G 1	40	16	22,8	17	200	12,80	FI-VS-R1-WD-B-W3
315	G 1 1/4	50	16	22,8	22	320	19,90	FI-VS-R1-1/4-WD-B-W3
315	G 1 1/2	55	16	22,8	24	400	26,20	FI-VS-R1-1/2-WD-B-W3
250	G 2	75	24	34	24	750	73	FI-VS-R2-WD-B-W3

Standard seal material is NBR (Buna-N®).

Male threaded studs were designed for female threaded ports in components made of steel. For applications with components made of softer mating materials (e.g. Aluminium), the use of connectors with additionally rolled male threads is recommended.

Please contact STAUFF prior to the assembly for further information.

Male stud acc. to ISO 1179-2 (Type E)
Port acc. to ISO 1179-1

Torque recommendations with a tolerance of +10% and refer to original components from the STAUFF Connect product range made of steel with zinc/nickel coating and apply for Steel mating material.



Blanking Screw for Ports
Type FI-VS-...-M-WD

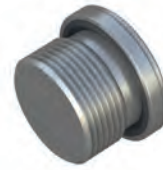
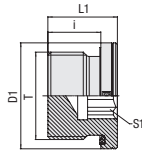

Profile Sealing Ring

Metric Parallel Thread

PN bar	Dimensions mm					Torque N-m	Weight kg ca. per 100	Ordering Codes
	Thread T	D1	i	L1	S1			
400	M 8 x 1	12	8	12	4	10	0,50	FI-VS-M8x1-WD-B-W3
400	M 10 x 1	14	8	12,3	5	12	0,70	FI-VS-M10x1-WD-B-W3
400	M 12 x 1,5	17	12	17,3	6	23	1,50	FI-VS-M12x1.5-WD-B-W3
400	M 14 x 1,5	19	12	17,3	6	30	2,00	FI-VS-M14x1.5-WD-B-W3
400	M 16 x 1,5	22	12	17,3	8	50	2,60	FI-VS-M16x1.5-WD-B-W3
400	M 18 x 1,5	24	12	17,3	8	65	3,30	FI-VS-M18x1.5-WD-B-W3
400	M 20 x 1,5	26	14	19,3	10	80	4,30	FI-VS-M20x1.5-WD-B-W3
400	M 22 x 1,5	27	14	19,3	10	90	5,10	FI-VS-M22x1.5-WD-B-W3
400	M 26 x 1,5	32	16	21,3	12	100	8,00	FI-VS-M26x1.5-WD-B-W3
400	M 27 x 2	32	16	21,3	12	130	8,20	FI-VS-M27x2-WD-B-W3
400	M 33 x 2	40	16	22,8	17	250	13,10	FI-VS-M33x2-WD-B-W3
250	M 42 x 2	50	16	22,8	22	310	20,40	FI-VS-M42x2-WD-B-W3
250	M 48 x 2	55	16	22,8	24	380	26,90	FI-VS-M48x2-WD-B-W3

Standard seal material is NBR (Buna-N®).

Male threaded studs were designed for female threaded ports in components made of steel. For applications with components made of softer mating materials (e.g. Aluminium), the use of connectors with additionally rolled male threads is recommended.

Please contact STAUFF prior to the assembly for further information.

Male stud acc. to ISO 9974-2 (Type E)
Port acc. to ISO 9974-1

Torque recommendations with a tolerance of +10% and refer to original components from the STAUFF Connect product range made of steel with zinc/nickel coating and apply for Steel mating material.

Ordering Codes

***FI-VS*-M*12x1.5*-WD*-B*-W3**

* Blanking Screw for Ports		FI-VS
* Thread Type	Metric Parallel Thread	M
* Thread Size	acc. to dimension table	12x1.5
Please always indicate thread sizes, e.g. 12x1.5!		
* Seal Type	Profile Sealing Ring	-WD
* Seal Material	NBR (Buna-N®) FKM (Viton®)	-B -V
* Material Code	Steel, zinc/nickel-plated	-W3

Please contact STAUFF for alternative materials and surface finishings.

Spare Parts / Accessories



Profile Sealing Ring
Type **WDG**

Page 238



Blanking Screw for Ports Type FI-VS-...-R

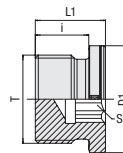

Ordering Codes

FI-VS-R*1/2*-W3

* Blanking Screw for Ports

* Thread Type Whitworth Parallel
Pipe Thread (BSPP)

* Thread Size acc. to dimension table

Please always indicate thread sizes, e.g. 1/2!

* Material Code Steel, zinc/nickel-plated

Please contact STAUFF for alternative
materials and surface finishings.

FI-VS

R

1/2

-W3

Whitworth Parallel Pipe Thread (BSPP)

PN bar	Dimensions mm					Torque N-m	Weight kg ca. per 100	Ordering Codes
	Thread T	D1	i	L1	S1			
400	G 1/8	14	8	12,3	5	25	0,70	FI-VS-R1/8-W3
400	G 1/4	18	12	17,3	6	40	1,80	FI-VS-R1/4-W3
400	G 3/8	22	12	17,3	8	95	2,70	FI-VS-R3/8-W3
400	G 1/2	26	14	19,3	10	130	4,60	FI-VS-R1/2-W3
400	G 3/4	32	16	21,3	12	250	7,90	FI-VS-R3/4-W3
400	G 1	39	16	22,8	17	400	12,80	FI-VS-R1-W3
315	G 1 1/4	49	16	22,8	22	600	19,30	FI-VS-R1-1/4-W3
315	G 1 1/2	55	16	22,8	24	800	26,10	FI-VS-R1-1/2-W3

Metallic Sealing Edge

Male threaded studs were designed for female threaded ports in components made of steel. For applications with components made of softer mating materials (e.g. Aluminium), the use of connectors with additionally rolled male threads is recommended.

Please contact STAUFF prior to the assembly for further information.

Male stud acc. to DIN 3852-2 (Form B) / ISO 1179-4 (Type B)
Port acc. to DIN 3852-2 (Form X) / ISO 1179-1

Torque recommendations with a tolerance of +10% and refer to original components from the STAUFF Connect product range made of steel with zinc/nickel coating and apply for Steel mating material.



Blanking Screw for Ports Type FI-VS-...-M-OR

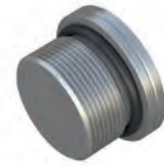
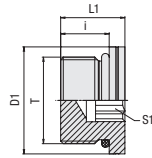

O-Ring

Metric Parallel Thread

PN bar	Dimensions mm					Torque N-m	Weight kg ca. per 100	Ordering Codes
	Thread T	D1	i	L1	S1			
630	M 10 x 1	13,8	9,5	13,5	5	15	0,8	FI-VS-M10x1-OR-B-W3
630	M 12 x 1,5	16,8	11	15,5	6	22	1,4	FI-VS-M12x1.5-OR-B-W3
630	M 14 x 1,5	18,8	11	16	6	45	2,0	FI-VS-M14x1.5-OR-B-W3
630	M 16 x 1,5	21,8	12,5	17,5	8	55	2,7	FI-VS-M16x1.5-OR-B-W3
630	M 18 x 1,5	23,8	14	19	8	70	3,8	FI-VS-M18x1.5-OR-B-W3
630	M 22 x 1,5	26,8	15	20	10	100	5,5	FI-VS-M22x1.5-OR-B-W3
400	M 26 x 1,5	31,8	16	21	12	170	7,7	FI-VS-M26x1.5-OR-B-W3
400	M 27 x 2	31,8	18,5	23,5	12	180	9,4	FI-VS-M27x2-OR-B-W3
400	M 33 x 2	40,8	18,5	24,5	14	215	15,6	FI-VS-M33x2-OR-B-W3
400	M 42 x 2	49,8	19	25	22	330	24,5	FI-VS-M42x2-OR-B-W3
400	M 48 x 2	54,8	21,5	27,5	24	420	37,1	FI-VS-M48x2-OR-B-W3

Standard seal material is NBR (Buna-N®).

Male stud acc. to ISO 6149-2/-3
Port acc. to ISO 6149-1

Male threaded studs were designed for female threaded ports in components made of steel. For applications with components made of softer mating materials (e.g. Aluminium), the use of connectors with additionally rolled male threads is recommended.

Please contact STAUFF prior to the assembly for further information.

Torque recommendations with a tolerance of +10% and refer to original components from the STAUFF Connect product range made of steel with zinc/nickel coating and apply for Steel mating material.

Ordering Codes

FI-VS-M*12x1.5*-OR*-B*-W3

* Blanking Screw for Ports		FI-VS
* Thread Type	Metric Parallel Thread	M
* Thread Size	acc. to dimension table	12x1.5
Please always indicate thread sizes, e.g. 12x1.5!		
* Seal Type	O-Ring	-OR
* Seal Material	NBR (Buna-N®) FKM (Viton®)	-B -V
* Material Code	Steel, zinc/nickel-plated	-W3

Please contact STAUFF for alternative materials and surface finishings.

Spare Parts / Accessories



O-Ring
Type **O-RING**

Page 239



Blanking Plug with 24° Taper / O-Ring (DKO) Type FI-VD ▪ Series L / S

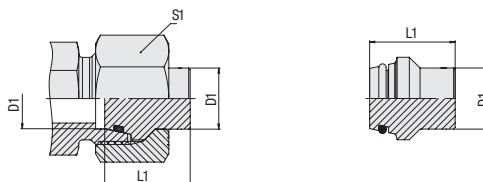

Ordering Codes

***FI-VD*-15*L*-V*-W3*-M**

* Blanking Plug with 24° Taper / O-Ring (DKO)		FI-VD
* Outside Tube Diameter D1 (in mm)		-15
* Series	Light Series	L
	Heavy Series	S
* Seal Material	FKM (Viton®)	-V
* Material Code	Steel, zinc/nickel-plated	-W3
Please contact STAUFF for alternative materials and surface finishings.		
* Assembling	Blanking plug only	—
	Blanking plug assembled with union nut	-M

Series	Tube OD	PN bar	Dimensions mm		Weight kg ca. per 100	Ordering Codes ³ Blanking plug only	Ordering Codes Blanking plug with union nut	
	mm D1		L1 ¹	S1				
L	6	800	16,5	14	0,57	FI-VD-06L/S-V-W3	FI-VD-06L-V-W3-M	
	8	800	16,5	17	0,90	FI-VD-08L/S-V-W3	FI-VD-08L-V-W3-M	
	10	800	17	19	1,37	FI-VD-10L/S-V-W3	FI-VD-10L-V-W3-M	
	12	630	17	22	1,88	FI-VD-12L/S-V-W3	FI-VD-12L-V-W3-M	
	15	400	18	27	3,00	FI-VD-15L-V-W3	FI-VD-15L-V-W3-M	
	18	400	18,5	32	4,36	FI-VD-18L-V-W3	FI-VD-18L-V-W3-M	
	22	250	19,3	36	6,52	FI-VD-22L-V-W3	FI-VD-22L-V-W3-M	
	28	250	19,7	41	10,45	FI-VD-28L-V-W3	FI-VD-28L-V-W3-M	
	35	250	23,2	50	19,66	FI-VD-35L-V-W3	FI-VD-35L-V-W3-M	
	42	250	23,2	60	27,73	FI-VD-42L-V-W3	FI-VD-42L-V-W3-M	
	S	6	800	16,5	17	0,57	FI-VD-06L/S-V-W3	FI-VD-06S-V-W3-M
		8	800	16,5	19	0,90	FI-VD-08L/S-V-W3	FI-VD-08S-V-W3-M
10		800	17	22	1,37	FI-VD-10L/S-V-W3	FI-VD-10S-V-W3-M	
12		630	17	24	1,88	FI-VD-12L/S-V-W3	FI-VD-12S-V-W3-M	
14		630	19	27	2,78	FI-VD-14S-V-W3	FI-VD-14S-V-W3-M	
16		630	19	30	3,54	FI-VD-16S-V-W3	FI-VD-16S-V-W3-M	
20		420	23,3	36	6,97	FI-VD-20S-V-W3	FI-VD-20S-V-W3-M	
25		420	24,2	46	10,94	FI-VD-25S-V-W3	FI-VD-25S-V-W3-M	
30		420	25,4	50	16,34	FI-VD-30S-V-W3	FI-VD-30S-V-W3-M	
38		420	26,7	60	27,11	FI-VD-38S-V-W3	FI-VD-38S-V-W3-M	

Connecting Parts



Union Nut
Type **FI-M**

Page 33

Spare Parts / Accessories



O-Ring
Type **O-RING**

Page 239

¹ Approximate dimension in assembled condition.

² Weight excluding union nut.

³ Standard scope of delivery: Blanking plug only.

Standard seal material is FKM (Viton®).



Blanking Plug with Sealing Edge Type FI-BUZ • Series L / S

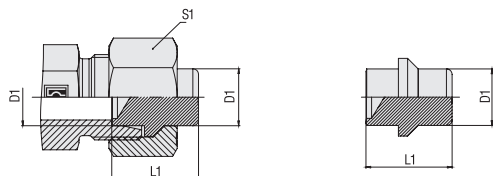

Series	Tube OD mm D1	PN bar	Dimensions mm		Weight kg ca. per 100	Ordering Codes ³
			L1 ¹	S1		
L	6	500	19,5	14	0,55	FI-BUZ-06L/S-W3
	8	500	19,5	17	0,90	FI-BUZ-08L/S-W3
	10	500	21,5	19	1,48	FI-BUZ-10L/S-W3
	12	400	22	22	2,13	FI-BUZ-12L/S-W3
	15	400	22	27	3,20	FI-BUZ-15L-W3
	18	400	24	32	5,00	FI-BUZ-18L-W3
	22	250	26	36	7,90	FI-BUZ-22L-W3
	28	250	25,5	41	11,90	FI-BUZ-28L-W3
	35	250	32	50	23,50	FI-BUZ-35L-W3
	42	250	32,5	60	38,50	FI-BUZ-42L-W3
S	6	800	19,5	17	0,55	FI-BUZ-06L/S-W3
	8	800	19,5	19	0,90	FI-BUZ-08L/S-W3
	10	800	21,5	22	1,48	FI-BUZ-10L/S-W3
	12	630	22	24	2,13	FI-BUZ-12L/S-W3
	14	630	23,5	27	3,12	FI-BUZ-14S-W3
	16	630	25,5	30	4,27	FI-BUZ-16S-W3
	20	400	30,5	36	8,00	FI-BUZ-20S-W3
	25	400	32,5	46	17,90	FI-BUZ-25S-W3
	30	400	35,5	50	20,00	FI-BUZ-30S-W3
	38	400	42	60	36,60	FI-BUZ-38S-W3

¹ Approximate dimension in assembled condition.

² Weight excluding union nut.

³ Standard scope of delivery: Blanking plug only.

Ordering Codes

***FI-BUZ*-15*L*-W3*-M**

* Blanking Plug with Sealing Edge	FI-BUZ
* Outside Tube Diameter D1 (in mm)	-15
* Series	Light Series L Heavy Series S
* Material Code	Steel, zinc/nickel-plated -W3
Please contact STAUFF for alternative materials and surface finishings.	
* Assembling / Kitting	Blanking plug only — Blanking plug supplied with union nut -M

Connecting Parts



Union Nut
Type FI-M

Page 33



Blanking Plug for Tube Ends Type FI-VSK ▪ Series L / S

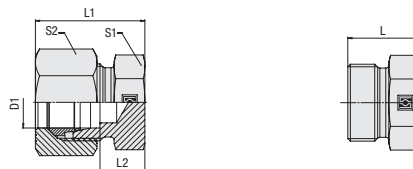

Ordering Codes

FI-VSK-10*L*-W3*-MS

* Blanking Plug for Tube Ends		FI-VSK
* Outside Tube Diameter D1 (in mm)		-10
* Series	Light Series	L
	Heavy Series	S
* Material Code	Steel, zinc/nickel-plated	-W3
Please contact STAUFF for alternative materials and surface finishings.		
* Assembling / Kitting	Blanking plug only	—
	Blanking plug supplied with cutting ring and union nut	-MS
	Blanking plug supplied with soft-sealing cutting ring and union nut	-MSV

Series	Tube OD mm D1	PN bar	Dimensions mm					Weight kg ca. per 100	Ordering Codes ³
			L	L1 ¹	L2	S1	S2		
L	6	315	17	22	7	14	14	1,40	FI-VSK-06L-W3
	8	315	17	23	8	17	17	1,93	FI-VSK-08L-W3
	10	315	20	24	9	17	19	2,55	FI-VSK-10L-W3
	12	315	21	25	10	19	22	3,44	FI-VSK-12L-W3
	15	315	20	26	11	24	27	4,90	FI-VSK-15L-W3
	18	315	21	28	11,5	27	32	6,80	FI-VSK-18L-W3
	22	160	23	30	13,5	32	36	10,70	FI-VSK-22L-W3
	28	160	23	31	14,5	41	41	15,20	FI-VSK-28L-W3
	35	160	29	36	14,5	46	50	25,90	FI-VSK-35L-W3
	42	160	30	39	16	55	60	35,30	FI-VSK-42L-W3
S	6	630	17	26	11	17	17	1,80	FI-VSK-06S-W3
	8	630	17	28	13	17	19	2,16	FI-VSK-08S-W3
	10	630	20	29	12,5	19	22	3,34	FI-VSK-10S-W3
	12	630	21	31	14,5	22	24	4,60	FI-VSK-12S-W3
	14	630	23	34	16	24	27	5,88	FI-VSK-14S-W3
	16	420	24	34	15,5	27	30	7,54	FI-VSK-16S-W3
	20	420	28	39	17,5	32	36	12,50	FI-VSK-20S-W3
	25	420	31	44	20	41	46	21,40	FI-VSK-25S-W3
	30	420	34	47	20,5	46	50	30,40	FI-VSK-30S-W3
	38	420	38	54	23	55	60	40,80	FI-VSK-38S-W3

Connecting Parts

	Cutting Ring Type FI-DS	Page 28
	Soft-Sealing Cutting Ring Type FI-WDDS	Page 29
	Support Sleeve Type FI-VH	Page 31
	STAUFF Form EVO Sealing Ring Type FI-FD	Page 32
	Union Nut Type FI-M	Page 33
	37° Flared Tube Fitting Set Type FI-AB	Page 37

¹ Approximate dimension in assembled condition.

² Weight excluding cutting ring and union nut.

³ Standard scope of delivery: Blanking plug only.

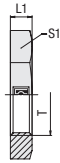

Hexagon Lock Nut
 Type FI-SKM • Series L / S

for Straight Bulkhead Fittings / Bulkhead Elbows

Series	Dimensions mm			Weight kg ca. per 100	Ordering Codes
	Thread T	L1	S1		
L	M 12 x 1,5	6	17	0,66	FI-SKM-06L-W3
	M 14 x 1,5	6	19	0,76	FI-SKM-08L/06S-W3
	M 16 x 1,5	6	22	1,04	FI-SKM-10L/08S-W3
	M 18 x 1,5	6	24	1,17	FI-SKM-12L/10S-W3
	M 22 x 1,5	7	30	2,25	FI-SKM-15L/14S-W3
	M 26 x 1,5	8	36	3,75	FI-SKM-18L-W3
	M 30 x 2	8	41	4,79	FI-SKM-22L/20S-W3
	M 36 x 2	9	46	5,90	FI-SKM-28L/25S-W3
	M 45 x 2	9	55	7,60	FI-SKM-35L-W3
S	M 52 x 2	10	65	12,20	FI-SKM-42L/38S-W3
	M 14 x 1,5	6	19	0,76	FI-SKM-08L/06S-W3
	M 16 x 1,5	6	22	1,04	FI-SKM-10L/08S-W3
	M 18 x 1,5	6	24	1,17	FI-SKM-12L/10S-W3
	M 20 x 1,5	6	27	1,54	FI-SKM-12S-W3
	M 22 x 1,5	7	30	2,25	FI-SKM-15L/14S-W3
	M 24 x 1,5	7	32	2,40	FI-SKM-16S-W3
	M 30 x 2	8	41	4,79	FI-SKM-22L/20S-W3
	M 36 x 2	9	46	5,90	FI-SKM-28L/25S-W3
	M 42 x 2	9	50	5,70	FI-SKM-30S-W3
	M 52 x 2	10	65	12,20	FI-SKM-42L/38S-W3

Ordering Codes

***FI-SKM*-06*L*-W3**

* Hexagon Lock Nut for Bulkhead Fittings	FI-SKM
* Outside Tube Diameter D1 (in mm)	-06
* Series	Light Series L Heavy Series S
* Material Code	Steel, zinc/nickel-plated -W3

Please contact STAUFF for alternative materials and surface finishings.



Profile Sealing Ring for Male Studs Type WDG



Whitworth Parallel Pipe Thread (BSPP)

Male stud acc. to ISO 1179-2 (Type E) / Port according to ISO 1179-1

Dimensions mm				Ordering Codes	
for Thread	D1	D2	L1	NBR (Buna-N®)	FKM (Viton®)
G 1/8	8,4	11,9	1	WDG-8.4x11.9x1-B90	WDG-8.4x11.9x1-V90
G 1/4	11,6	16,5	1,5	WDG-11.6x16.5x1.5-B90	WDG-11.6x16.5x1.5-V90
G 3/8	14,7	18,9	1,5	WDG-14.7x18.9x1.5-B90	WDG-14.7x18.9x1.5-V90
G 1/2	18,5	23,9	1,5	WDG-18.5x23.9x1.5-B90	WDG-18.5x23.9x1.5-V80
G 3/4	23,9	29,2	1,5	WDG-23.9x29.2x1.5-B90	WDG-23.9x29.2x1.5-V80
G 1	29,7	35,7	2	WDG-29.7x35.7x2-B90	WDG-29.7x35.7x2-V80
G 1 1/4	38,8	45,8	2	WDG-38.8x45.8x2-B90	WDG-38.8x45.8x2-V80
G 1 1/2	44,7	50,7	2	WDG-44.7x50.7x2-B90	WDG-44.7x50.7x2-V80

Metric Parallel Thread

Male stud according to ISO 9974-2 (Type E) / Port according to ISO 9974-1

Dimensions mm				Ordering Codes	
for Thread	D1	D2	L1	NBR (Buna-N®)	FKM (Viton®)
M 8 x 1	6,5	9,9	1	WDG-6.5x9.9x1-B90	WDG-6.5x9.9x1-V90
M 10 x 1	8,4	11,9	1	WDG-8.4x11.9x1-B90	WDG-8.4x11.9x1-V90
M 12 x 1,5	9,8	14,5	1,5	WDG-9.8x14.5x1.5-B90	WDG-9.8x14.5x1.5-V90
M 14 x 1,5	11,6	16,5	1,5	WDG-11.6x16.5x1.5-B90	WDG-11.6x16.5x1.5-V90
M 16 x 1,5	13,8	18,9	1,5	WDG-13.8x18.9x1.5-B80	WDG-13.8x18.9x1.5-V80
M 18 x 1,5	15,7	20,9	1,5	WDG-15.7x20.9x1.5-B90	WDG-15.7x20.9x1.5-V80
M 20 x 1,5	17,8	22,9	1,5	WDG-17.8x22.9x1.5-B90	WDG-17.8x22.9x1.5-V90
M 22 x 1,5	19,6	24,3	1,5	WDG-19.6x24.3x1.5-B90	WDG-19.6x24.3x1.5-V90
M 26 x 1,5	23,9	29,2	1,5	WDG-23.9x29.2x1.5-B90	WDG-23.9x29.2x1.5-V80
M 27 x 2	23,9	29,2	1,5	WDG-23.9x29.2x1.5-B90	WDG-23.9x29.2x1.5-V80
M 33 x 2	29,7	35,7	2	WDG-29.7x35.7x2-B90	WDG-29.7x35.7x2-V80
M 42 x 2	38,8	45,8	2	WDG-38.8x45.8x2-B90	WDG-38.8x45.8x2-V80
M 48 x 2	44,7	50,7	2	WDG-44.7x50.7x2-B90	WDG-44.7x50.7x2-V80



O-Ring for Male Studs
 Type O-RING

Male stud according to ISO 6149-2/-3 / Port according to ISO 6149-1

Metric Parallel Thread

Dimensions mm for Thread	Ordering Codes	
	NBR (Buna-N®)	FKM (Viton®)
M 8 x 1	O-RING-6.07x1.63-B90	O-RING-6.07x1.63-V90
M 10 x 1	O-RING-8.1x1.6-B90	O-RING-8.1x1.6-V90
M 12 x 1,5	O-RING-9.3x2.2-B90	O-RING-9.3x2.2-V90
M14 x 1,5	O-RING-11.3x2.2-B90	O-RING-11.3x2.2-V90
M16 x 1,5	O-RING-13.3x2.2-B90	O-RING-13.3x2.2-V90
M18 x 1,5	O-RING-15.3x2.2-B90	O-RING-15.3x2.2-V90
M22 x 1,5	O-RING-19.3x2.2-B90	O-RING-19.3x2.2-V90
M26 x 1,5	O-RING-23.3x2.4-B90	O-RING-23.3x2.4-V90
M27 x 2	O-RING-23.6x2.9-B90	O-RING-23.6x2.9-V90
M30 x 2	O-RING-26.62 x2.95-B90	O-RING-26.62 x2.95-V90
M33 x 2	O-RING-29.6x2.9-B90	O-RING-29.6x2.9-V90
M42 x 2	O-RING-38.6x2.9-B90	O-RING-38.6x2.9-V90
M48 x 2	O-RING-44.6x2.9-B90	O-RING-44.6x2.9-V90

Male stud according to ISO 11926-2/-3 / Port according to ISO 11926-1

UN / UNF Thread

Dimensions mm for Thread	Ordering Codes	
	NBR (Buna-N®)	FKM (Viton®)
7/16-20 UNF	O-RING-8.92x1.83-B90	O-RING-8.92x1.83-V90
1/2-20 UNF	O-RING-10.52x1.83-B90	O-RING-10.52x1.83-V90
9/16-18 UNF	O-RING-11.89x1.98-B90	O-RING-11.89x1.98-V90
3/4-16 UNF	O-RING-16.36x2.2-B90	O-RING-16.36x2.2-V90
7/8-14 UNF	O-RING-19.18x2.46-B90	O-RING-19.18x2.46-V 90
1 1/16-12 UN	O-RING-23.47x2.95-B90	O-RING-23.47x2.95-V80
1 3/16-12 UN	O-RING-26.62 x2.95-B90	O-RING-26.62 x 2.95-V90
1 5/16-12 UN	O-RING-29.74x2.95-B90	O-RING-29.74x2.95-V90
1 5/8-12 UN	O-RING-37.47x3-B90	O-RING-37.47x3-V90
1 7/8-12 UN	O-RING-43.69x3-B90	O-RING-43.69x3-V90

Whitworth Parallel Pipe Thread (BSPP)

Dimensions mm for Thread	Ordering Codes	
	NBR (Buna-N®)	FKM (Viton®)
G 1/8	O-RING-7.97x1.88-B90	O-RING-7.97x1.88-V90
G 1/4	O-RING-10.77x2.62-B90	O-RING-10.77x2.62-V90
G 3/8	O-RING-13.94x2.62-B90	O-RING-13.94x2.62-V90
G 1/2	O-RING-17.86x2.62-B90	O-RING-17.86x2.62-V90
G 3/4	O-RING-23.47x2.62-B90	O-RING-23.47x2.62-V90
G 1	O-RING-29.74x3.53-B90	O-RING-29.74x3.53-V90
G 1 1/4	O-RING-37.69x3.53-B90	O-RING-37.69x3.53-V90
G 1 1/2	O-RING-44.04x3.53-B90	O-RING-44.04x3.53-V90



O-Ring for 24°/37° Flared Cone Adaptors Type O-RING



24° Taper of the Flared Cone Adaptor

Series	Tube OD mm	Ordering Codes	
		NBR (Buna-N®)	FKM (Viton®)
L	6	O-RING-4.5x1.5-B90	O-RING-4.5x1.5-V90
	8	O-RING-6.5x1.5-B90	O-RING-6.5x1.5-V90
	10	O-RING-8.5x1.5-B90	O-RING-8.5x1.5-V90
	12	O-RING-10x1.5-B90	O-RING-10x1.5-V90
	15	O-RING-12.5x2-B90	O-RING-12.5x2-V90
	18	O-RING-16x2-B90	O-RING-16x2-V90
	22	O-RING-20x2-B90	O-RING-20x2-V90
	28	O-RING-26x2-B90	O-RING-26x2-V90
	35	O-RING-32x2.5-B90	O-RING-32x2.5-V90
	42	O-RING-38x2.5-B90	O-RING-38x2.5-V90
S	6	O-RING-4.5x1.5-B90	O-RING-4.5x1.5-V90
	8	O-RING-6.5x1.5-B90	O-RING-6.5x1.5-V90
	10	O-RING-8.5x1.5-B90	O-RING-8.5x1.5-V90
	12	O-RING-10x1.5-B90	O-RING-10x1.5-V90
	14	O-RING-12x2-B90	O-RING-12x2-V90
	16	O-RING-14x2-B90	O-RING-14x2-V90
	20	O-RING-17.3x2.4-B90	O-RING-17.3x2.4-V90
	25	O-RING-22.3x2.4-B90	O-RING-22.3x2.4-V90
	30	O-RING-27.3x2.4-B90	O-RING-27.3x2.4-V90
	38	O-RING-35x2.5-B90	O-RING-35x2.5-V90



O-Ring for 24°/37° Flared Cone Adaptors Type O-RING



37° Taper of the Flared Cone Adaptor

Series	Tube OD mm	Ordering Codes	
		NBR (Buna-N®)	FKM (Viton®)
L	6	O-RING-4.4x0.8-B90	O-RING-4.4x0.8-V90
	8	O-RING-6x0.8-B90	O-RING-6x0.8-V90
	10	O-RING-7.5x0.8-B90	O-RING-7.5x0.8-V90
	12	O-RING-9.5x0.8-B90	O-RING-9.5x0.8-V90
	15	O-RING-12.5x0.8-B90	O-RING-12.5x0.8-V90
	18	O-RING-15x1-B90	O-RING-15x1-V90
	22	O-RING-18x1-B90	O-RING-18x1-V90
	28	O-RING-23x1-B90	O-RING-23x1-V90
	35	O-RING-30x1-B90	O-RING-30x1-V90
	42	O-RING-37x1-B90	O-RING-37x1-V90
S	6	O-RING-4.4x0.8-B90	O-RING-4.4x0.8-V90
	8	O-RING-6x0.8-B90	O-RING-6x0.8-V90
	10	O-RING-7.5x0.8-B90	O-RING-7.5x0.8-V90
	12	O-RING-9.5x0.8-B90	O-RING-9.5x0.8-V90
	14	O-RING-11x1-B90	O-RING-11x1-V90
	16	O-RING-12.5x1-B90	O-RING-12.5x1-V90
	20	O-RING-16x1-B90	O-RING-16x1-V90
	25	O-RING-20x1-B90	O-RING-20x1-V90
	30	O-RING-25x1-B90	O-RING-25x1-V90
	38	O-RING-32x1.8-B90	O-RING-32x1.8-V90



O-Ring for for DKO Taper Fittings / 24° Weld Cones Type O-RING



Series	Tube OD mm	Ordering Codes	
		NBR (Buna-N®)	FKM (Viton®)
L	6	O-RING-4.5x1.5-B90	O-RING-4.5x1.5-V90
	8	O-RING-6.5x1.5-B90	O-RING-6.5x1.5-V90
	10	O-RING-8.5x1.5-B90	O-RING-8.5x1.5-V90
	12	O-RING-10x1.5-B90	O-RING-10x1.5-V90
	15	O-RING-12.5x2-B90	O-RING-12.5x2-V90
	18	O-RING-16x2-B90	O-RING-16x2-V90
	22	O-RING-20x2-B90	O-RING-20x2-V90
	28	O-RING-26x2-B90	O-RING-26x2-V90
	35	O-RING-32x2.5-B90	O-RING-32x2.5-V90
	42	O-RING-38x2.5-B90	O-RING-38x2.5-V90
S	6	O-RING-4.5x1.5-B90	O-RING-4.5x1.5-V90
	8	O-RING-6.5x1.5-B90	O-RING-6.5x1.5-V90
	10	O-RING-8.5x1.5-B90	O-RING-8.5x1.5-V90
	12	O-RING-10x1.5-B90	O-RING-10x1.5-V90
	14	O-RING-12x2-B90	O-RING-12x2-V90
	16	O-RING-14x2-B90	O-RING-14x2-V90
	20	O-RING-17.3x2.4-B90	O-RING-17.3x2.4-V90
	25	O-RING-22.3x2.4-B90	O-RING-22.3x2.4-V90
	30	O-RING-27.3x2.4-B90	O-RING-27.3x2.4-V90
	38	O-RING-35x2.5-B90	O-RING-35x2.5-V90



O-Ring for Banjo Bolts of Banjo Fittings Type O-RING



Dimensions mm for Thread		for Tube Size / Series	Ordering Codes	
			NBR (Buna-N®)	FKM (Viton®)
G 1/8		4LL / 6LL / 8LL / 6L	O-RING-8.5x1.5-B90	O-RING-8.5x1.5-V90
G 1/4		8L / 10L / 12L / 6S / 8S	O-RING-11x2-B90	O-RING-11x2-V90
G 3/8		12L / 10S / 12S	O-RING-14.5x2-B90	O-RING-14.5x2-V90
G 1/2		15L / 18L / 14S / 16S	O-RING-19.5x2-B90	O-RING-19.5x2-V90
G 3/4		22L / 20S	O-RING-26x1.5-B90	O-RING-26x1.5-V90
G 1		28L / 25S	O-RING-31x2-B90	O-RING-31x2-V90
G 1 1/4		35L / 30S	O-RING-40x2-B90	O-RING-40x2-V90
G 1 1/2		42L / 38S	O-RING-46x2-B90	O-RING-46x2-V90
M 8 x 1		4LL	O-RING-6.5x1.5-B90	O-RING-6.5x1.5-V90
M 10 x 1		6LL / 8LL / 6L	O-RING-8.5x1.5-B90	O-RING-8.5x1.5-V90
M 12 x 1,5		8L / 6S	O-RING-11x2-B90	O-RING-11x2-V90
M 14 x 1,5		10L / 8S / 12L	O-RING-11x2-B90	O-RING-11x2-V90
M 16 x 1,5		12L / 10S	O-RING-14.5x2-B90	O-RING-14.5x2-V90
M 18 x 1,5		12L / 10S	O-RING-14.5x2-B90	O-RING-14.5x2-V90
M 18 x 1,5		15L / 12S	O-RING-16.5x2-B90	O-RING-16.5x2-V90
M 20 x 1,5		14S	O-RING-19.5x2-B90	O-RING-19.5x2-V90
M 22 x 1,5		18L / 16S	O-RING-19.5x2-B90	O-RING-19.5x2-V90
M 26 x 1,5		22L	O-RING-26x1.5-B90	O-RING-26x1.5-V90
M 27 x 2		20S	O-RING-26x1.5-B90	O-RING-26x1.5-V90
M 33 x 2		28L / 25S	O-RING-31x2-B90	O-RING-31x2-V90
M 42 x 2		35L / 30S	O-RING-40x2-B90	O-RING-40x2-V90
M 48 x 2		42L / 38S	O-RING-46x2-B90	O-RING-46x2-V90



External Metallic Sealing Ring for Male Studs of Banjo Fittings Type FI-DKR



Dimensions mm					Ordering Codes
for Thread		D1	D2	L1	
M 8 x 1		8,05	10,8	4	FI-DKR-M8x1-W3-WOB
M 10 x 1	G 1/8	10,1	13	4	FI-DKR-M10x1-R1/8-W3-WOB
M 12 x 1,5		12,2	17,8	4	FI-DKR-M12x1.5-W3-WOB
	G 1/4	13,2	17,7	4	FI-DKR-R1/4-W3-WOB
M 14 x 1,5		14,1	17,7	4,4	FI-DKR-M14x1.5-W3-WOB
M 16 x 1,5		16,1	21,5	5	FI-DKR-M16x1.5-W3-WOB
	G 3/8	16,7	22	5	FI-DKR-R3/8-W3-WOB
M 18 x 1,5		18,1	23	5	FI-DKR-M18x1.5-W3-WOB
	G 1/2	21	26	7	FI-DKR-18L/16S-R1/2-W3-WOB
M 20 x 1,5	G 1/2	21	26	5	FI-DKR-15L/14S-M20x1.5-R1/2-W3-WOB
M 22 x 1,5		22,1	27	7	FI-DKR-M22x1.5-W3-WOB
M 26 x 1,5		26,1	31,5	5,5	FI-DKR-M26x1.5-W3-WOB
M 27 x 2	G 3/4	27,1	32	5,5	FI-DKR-M27x2-R3/4-W3-WOB
M 33 x 2		33,3	39	5,5	FI-DKR-M33x2-R1-W3-WOB
M 42 x 2	G 1 1/4	42,1	49	5,5	FI-DKR-M42x2-R1-1/4-W3-WOB
M 48 x 2	G 1 1/2	48,1	55	5,5	FI-DKR-M48x2-R1-1/2-W3-WOB



Retaining Ring with Captive Seal for Male Studs of Banjo Fittings Type FI-DIR

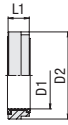

Dimensions mm for Thread						Ordering Codes
		Positioning	D1	D2	L1	
M 10 x 1	G 1/8	2	10,2	14,9	4,0	FI-DIR-M10x1-R1/8-B-W3
M 12 x 1,5		1	12,2	17,8	4,0	FI-DIR-M12x1.5-B-W3
	G 1/4	2	13,3	18,8	4,0	FI-DIR-R1/4-B-W3
M 14 x 1,5		2	14,1	19,9	4,0	FI-DIR-M14x1.5-B-W3
M 16 x 1,5	G 3/8	1	16,8	22,8	4,4	FI-DIR-M16x1.5-R3/8-B-W3/2
M 18 x 1,5		1	18,1	24,9	5,0	FI-DIR-M18x1.5-B-W3/2
M 18 x 1,5 (nur 12L)		1	18,1	24,5	4,6	FI-DIR-12LM18x1.5-B-W3
	G 1/2 (nur 15L / 14S)	1	21	27,9	5,0	FI-DIR-15L/14S-R1/2-B-W3/2
	G 1/2 (nur 18L / 16S)	1	21	27,9	7,0	FI-DIR-18L/16S-R1/2-B-W3/2
M 20 x 1,5		1	20,2	27,5	5,0	FI-DIR-M20x1.5-B-W3
M 22 x 1,5		1	22,1	27,9	7,0	FI-DIR-M22x1.5-B-W3
M 26 x 1,5		1	26,1	32,5	5,5	FI-DIR-M26x1.5-B-W3
M 27 x 2	G 3/4	1	27	32,9	5,5	FI-DIR-M27X2-R3/4-B-W3/2
M 33 x 2	G 1	1	33,4	40,9	5,5	FI-DIR-M33X2-R1-B-W3/2
M 42 x 2	G 1 1/4	1	42,1	50,9	5,5	FI-DIR-M42x2-R1-1/4-B-W3
M 48 x 2	G 1 1/2	1	47,8	55,9	5,5	FI-DIR-M48x2-R1-1/2-B-W3

Positioning and Orientation (also see page 320)

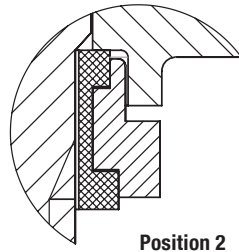
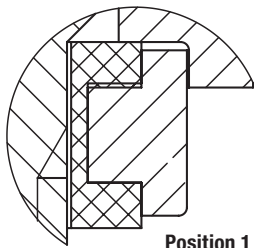

Internal Metallic Sealing Ring for Female Studs of Gauge Fittings Type FI-DKI



Dimensions mm				Ordering Codes
for Thread	D1	D2	L1	
G 1/4	6	11,3	4,5	FI-DKI-R1/4-W3-WOB
G 1/2	12	18,5	5	FI-DKI-R1/2-W3-WOB



Retaining Ring (Small) for Male Studs of Fittings with Lock Nut Type FI-KR

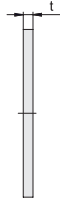
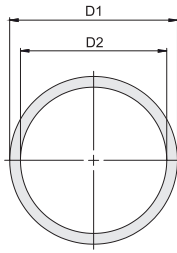

Dimensions mm for Thread	D1	D2	t	Ordering Codes
G 1/8	14,8	11,8	1,4	FI-KR-R1/8-W3-WOB
G 1/4	19,8	16,15	1,9	FI-KR-R1/4-W3-WOB
G 3/8	22,8	19,4	1,9	FI-KR-R3/8-W3-WOB
G 1/2	27,8	23,2	1,9	FI-KR-R1/2-W3-WOB
G 3/4	32,8	28,6	1,9	FI-KR-R3/4-W3-WOB
G 1	40,8	36,6	2,6	FI-KR-R1-W3-WOB
G 1 1/4	50,8	44,9	2,6	FI-KR-R1-1/4-W3-WOB
G 1 1/2	55,8	50,9	2,6	FI-KR-R1-1/2-W3-WOB
M 10 x 1	14,8	11,4	1,1	FI-KR-M10x1-W3-WOB
M 12 x 1,5	17,8	13,9	1,7	FI-KR-M12x1.5-W3-WOB
M 14 x 1,5	19,8	15,9	1,7	FI-KR-M14x1.5-W3-WOB
M 16 x 1,5	22,8	17,9	1,7	FI-KR-M16x1.5-W3-WOB
M 18 x 1,5	24,8	19,9	1,7	FI-KR-M18x1.5-W3-WOB
M 22 x 1,5	27,8	23,9	1,7	FI-KR-M22x1.5-W3-WOB
M 27 x 2	32,8	29,6	2,2	FI-KR-M27x2-W3-WOB
M 33 x 2	40,8	35,6	2,2	FI-KR-M33x2-W3-WOB
M 42 x 2	50,8	44,6	2,2	FI-KR-M42x2-W3-WOB
M 48 x 2	55,8	50,6	2,2	FI-KR-M48x2-W3-WOB
7/16-20 UNF	17	13	1,3	FI-KR-7/16U-W3-WOB
9/16-18 UNF	21	16,1	1,4	FI-KR-9/16U-W3-WOB
3/4-16 UNF	26,5	21	1,6	FI-KR-3/4U-W3-WOB
7/8-14 UNF	30	24,3	1,8	FI-KR-7/8U-W3-WOB
1 1/16-12 UN	37,5	29,6	2,2	FI-KR-1-1/16U-W3-WOB
1 5/16-12 UN	45	35,8	2,2	FI-KR-1-5/16U-W3-WOB
1 5/8-12 UN	56,5	43,7	2,2	FI-KR-1-5/8U-W3-WOB
1 7/8-12 UN	64	49,9	2,2	FI-KR-1-7/8U-W3-WOB





	Cutting Ring Final Assembly Machine with Cloud connection SPR-PRC-POC-A-A-IOT	250		STAUFF Form EVO Tube Forming Machine with Cloud connection SFO-F-A-A-IOT	272
	Cutting Ring Assembly Stud for Machine-Assisted Assembly FI-MFK	252		Cloud connection SFO-F-A-A-IOT	272
	Support Plate for Machine-Assisted Assembly FI-GP	253		Tube Shapers FI-FST	274
	Cloud connection SPR-PRC-POC-A-A-IOT	254		Internal Tube Supports FI-ID	274
	Optional tool holder for tubes with small bending radii SPR-PRC-POC-RTH	254		Clamping Jaws FI-FB	275
	Accessories	254		Accessories	276
	Cutting Ring Assembly and 37° Flaring Machine with Automatic / Manual Pressure Setting SPR-PRC-MA-D-A	256			
	Accessories	258			
	Cutting Ring Assembly Stud for Machine-Assisted Assembly FI-MFK	259			
	Support Plate for Machine-Assisted Assembly FI-GP-PRC	260			
	Clamping Jaws for 37° Flaring FI-KB-PRC	261			
	Portable Cutting Ring Assembly Machine with Manual Pressure Setting (Set) SPR-PRC-H-E-SET	262			
	Cutting Ring Assembly Stud for Machine-Assisted Assembly FI-MVK-PRC-H-M	264			
	Manual Cutting Ring Pre-Assembly Device SPR-PRC-MP	266			
	Cutting Ring Assembly Stud for Manual Assembly FI-MFK	267			
	Support Plate for Manual Assembly FI-GP-PRC	268			
	Final Assembly Stud for the Manual Cutting Ring Assembly FI-FK	270			
	Pre-Assembly Stud for the Manual Cutting Ring Assembly FI-VK	271			



STAUFF Press Cutting Ring Final Assembly Machine Type SPR-PRC-POC-A-A-IOT



Product Description

The STAUFF Press Assembly Machine SPR-PRC-POC-A-A-IOT allows the pressure/position-controlled final assembly of cutting rings from the Extra-Light Series (LL), the Light Series (L) and the Heavy Series (S) according to ISO 8434-1 / DIN 2353 on tube ends with outer diameters between 4 mm and 42 mm.

The machine is designed as a robust table-top device for continuous operation in the workshop. It is used in connection with hardened and wear-resistant assembly studs FI-FMK and support plates FI-GP which are specially designed for the machine-assisted assembly.

The combined pressure/position-control of the device allows wear on the assembly tools to be detected in time before it can have a negative influence on the assembly result. Maximum service life of the tools is achieved through careful handling of the components and practical operation of the assembly machine. Other factors are proper storage (protected against contamination and corrosion), regular cleaning and lubrication (with suitable lubricants) and thorough preparation of the tube ends before assembly (cutting, deburring and cleaning).

Short times for tool changes, setup and assembly make it possible to carry out series assembly of cutting rings as well as assembly of small and medium quantities with a high level of economic efficiency, reproducibility and process reliability. Among other things, this is achieved with the RFID transponders – which are integrated into the support plates for automatic tool size identification as a standard – and with the tool contact switch: this allows assembly processes to be automatically started and completed by simply pushing the tube end into the assembly stud without having to press any buttons. The assembly area is secured against interference by a light grid to comply with current accident prevention regulations.

With machine-assisted **final assembly**, the cutting ring has already cut 100% into the tube and the fitter only has to tighten the union nut by 30° (corresponds to 1/12 turns) from the fix point. Please pay attention to the corresponding assembly instruction.

Final assembly (100%) minimises the risk for errors (insufficient or excessive manual tightening) and the resulting leak potentials which can often lead to time consuming and expensive machine downtimes and environmental impact. Due to the time benefits during final tightening, final assembly by machine also generates clear saving potentials compared to manual direct assembly as well as to machine-assisted pre-assembly.

In case of incorrect or incomplete assembly where pressure and position parameters significantly deviate from the values stored in the machine, it automatically stops the assembly process and displays a corresponding warning message on the operating panel.

The integrated Cloud connection allows preventive maintenance via remote access and facilitates the documentation of assembly process. For more information please see page 256.



Operating elements of the assembly machine



Noise-reducing tool tray with durable rubber mat

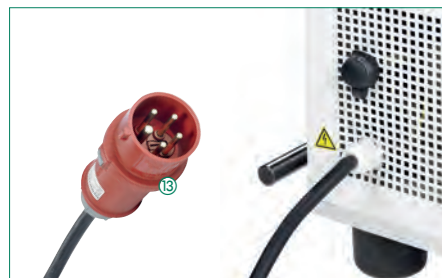

Electrical connection plug and Ethernet port (RJ45)



Lateral handle bars and rubber machine feet with suitable clearance height

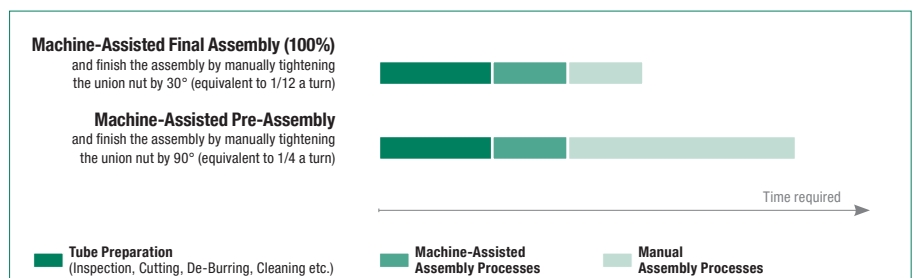

Comparison of the total times required for the assembly and installation of cutting ring connections (medium size)

P



STAUFF Press Cutting Ring Final Assembly Machine Type SPR-PRC-POC-A-A-IOT

Characteristics

Performance

- final assembly (100 %)
- Short times for tool changes, setup and assembly
- Tool size detection via RFID transponders in the support plates
- Automatic assembly start through integrated tool contact switch
- Tool wear detection through combined pressure/position-control
- Internal memory for up to 9 assembly programs which can be selected on the operating panel: predefined are tube materials steel E235 and E355 as well as stainless steel 316; parameters for other materials (copper, CuNiFe, Tungum, polyamide etc.) can be added by the manufacturer if required
- Counters for lot/batch sizes and total quantities (separated by tool size)
- Documented process control through programmable logic control (PLC)
- Predefined menu languages: English, German, French and Italian
- Manual pressure adjustment possible

Design

- ① Robust and ergonomically designed machine housing
- ② Optimised assembly area, which allows processing of tubes with low bending radii (to at least 31 mm distance from the tube axis to the interfering edge of the machine housing) or complex geometries
- ③ Noise-reducing tool tray with durable rubber mat
- ④ Lateral handle bars as attachment points for transport (e.g. with lifting belts)
- ⑤ Secure positioning thanks to flexible rubber machine feet
- ⑥ Type plate, with technical data, serial number, year of manufacture, etc.

Technical Data

Area of Application

- Function: final assembly (100%) of cutting rings on metric tube ends
- Operating principle: Assembly with combined pressure/position-control
- Series and diameters: Extra-Light Series (LL): 4, 6, 8, 10, 12 mm
Light Series (L): 6, 8, 10, 12, 15, 18, 22, 28, 35, 42 mm
Heavy Series (S): 6, 8, 10, 12, 14, 16, 20, 25, 30, 38 mm

Dimensions / Weight

- Dimensions (W x D x H): 780 mm x 650 mm x 305 mm with lateral handle bars (detachable)
- Distance from the tube axis to the interfering edge of the machine housing: 80 mm
- Clearance height: 65 mm (height of the machine feet) enables simple and safe transport using a forklift or pallet jack
- Weight: 95 kg (incl. operating fluid, excl. assembly tools)

Materials

- Machine frame: Aluminium
- Machine housing: Steel, painted
- Tool tray: NBR (Perbunan®)
- Machine feet: Natural rubber
- Assembly studs: Steel, PVD coated
- Support plates: Steel, browned

Operating Elements

- ⑦ Operating panel for display and selection of all relevant settings and assembly parameters
- ⑧ Button for definite confirmation of entries made on the operating panel
- ⑨ Status light to indicate readiness for operation and running assembly processes

Safety Devices

- ⑩ Main power switch (can be secured against unauthorised actuation when required)
- ⑪ Separate emergency stop button to immediately stop all machine movements
- ⑫ Light grid to protect users when reaching into the assembly area

Connections (at the back of the machine)

- ⑬ Electrical connection according to IEC 60309 CEE 16A (cable length: 4 m) and Ethernet connection (RJ45) for maintenance and data input by the manufacturer

Assembly Tools

- ⑭ Wear-resistant assembly stud FI-MFK
- ⑮ Support plate FI-GP with RFID transponder

Motor Configuration

- Power supply: 400 V AC @ 50 Hz - 3 phases
460 V AC @ 60 Hz - 3 phases
- Current consumption: 2,7 A
- Connected load: 0,9 kW
- Electrical connection: Phase reversing plug according to IEC 60309 CEE 16A
- Cable length: 4 m

Alternative motor configurations and plug types are available on request. Please contact STAUFF for details.

Hydraulic System

- Operating fluid: Hydraulic oil Shell Tellus S2 MA 46 or equivalent (filled and ready for operation when delivered)
- Fluid volume: 4 litres
- Max working pressure: 450 bar

Operating Conditions

- Storage temperature: -10°C ... +70°C
- Ambient temperature: +15°C ... +35°C
- Ambient conditions: Dry, no condensing humidity, operation in horizontal position only
- Noise emission: less than 66 dB(A) as per EN ISO 11202 at full-load operation with maximum tube dimensions

P



STAUFF Maintenance Contracts

Please contact STAUFF for a maintenance contract, that provides optimum service for your STAUFF assembly machine.



STAUFF Machine Rental

Please contact STAUFF for a rental machine and further details of what this service can offer.



Cutting Ring Assembly Stud for Machine-Assisted Assembly Type FI-MFK ▪ Series LL / L / S

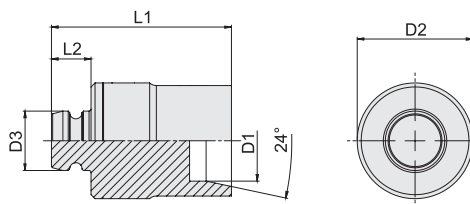

Series	Tube OD mm	Dimensions mm					Weight kg ca. per 100	Ordering Codes
		D1	D2	D3	L1	L2		
LL	4	30	14,8	50	10	12,98	FI-MFK-04LL-W100	
	6	30	14,8	50	10	13,28	FI-MFK-06LL-W100	
	8	30	14,8	50	10	13,68	FI-MFK-08LL-W100	
L	6	30	14,8	50	10	13,57	FI-MFK-06L-W100	
	8	30	14,8	50	10	14,01	FI-MFK-08L-W100	
	10	30	14,8	50	10	14,63	FI-MFK-10L-W100	
	12	30	14,8	50	10	16,09	FI-MFK-12L-W100	
	15	30	14,8	50	10	16,63	FI-MFK-15L-W100	
	18	30	14,8	50	10	18,23	FI-MFK-18L-W100	
	22	30	14,8	49	10	19,13	FI-MFK-22L-W100	
	28	33,8	14,8	48	10	24,43	FI-MFK-28L-W100	
	35	42,8	14,8	45	10	32,72	FI-MFK-35L-W100	
	42	49,8	14,8	44	10	41,17	FI-MFK-42L-W100	
S	6	30	14,8	50	10	14,14	FI-MFK-06S-W100	
	8	30	14,8	50	10	14,68	FI-MFK-08S-W100	
	10	30	14,8	50	10	15,23	FI-MFK-10S-W100	
	12	30	14,8	50	10	15,89	FI-MFK-12S-W100	
	14	30	14,8	49	10	15,98	FI-MFK-14S-W100	
	16	30	14,8	49	10	16,65	FI-MFK-16S-W100	
	20	30	14,8	45	10	16,43	FI-MFK-20S-W100	
	25	33,8	14,8	42	10	19,02	FI-MFK-25S-W100	
	30	39,8	14,8	40	10	22,88	FI-MFK-30S-W100	
	38	49,8	14,8	36	10	26,41	FI-MFK-38S-W100	

Materials / surface finishings: **W100** Steel, PVD coated

Accessories



Cone Gauges

Page 283

P

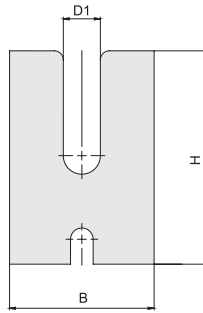
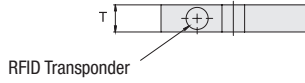

Support Plate for Machine-Assisted Assembly
 Type FI-GP ▪ Series LL / L / S

Series	Tube OD mm	Dimensions mm			Weight kg ca. per 100	Ordering Codes
		D1	B	H		
LL	4	80	118	15	104,43	FI-GP-04LL-W101
	6	80	118	15	102,97	FI-GP-06LL-W101
	8	80	118	15	101,46	FI-GP-08LL-W101
L	6	80	118	15	102,97	FI-GP-06L-W101
	8	80	118	15	101,46	FI-GP-08L-W101
	10	80	118	15	99,93	FI-GP-10L-W101
	12	80	118	15	98,35	FI-GP-12L-W101
	15	80	118	15	95,91	FI-GP-15L-W101
	18	80	118	15	93,40	FI-GP-18L-W101
	22	80	118	15	89,91	FI-GP-22L-W101
	28	80	118	15	84,41	FI-GP-28L-W101
	35	80	118	15	77,56	FI-GP-35L-W101
	42	80	118	15	70,27	FI-GP-42L-W101
S	6	80	118	15	102,97	FI-GP-06S-W101
	8	80	118	15	101,46	FI-GP-08S-W101
	10	80	118	15	99,93	FI-GP-10S-W101
	12	80	118	15	98,35	FI-GP-12S-W101
	14	80	118	15	96,73	FI-GP-14S-W101
	16	80	118	15	95,08	FI-GP-16S-W101
	20	80	118	15	91,67	FI-GP-20S-W101
	25	80	118	15	87,20	FI-GP-25S-W101
	30	80	118	15	82,50	FI-GP-30S-W101
	38	80	118	15	74,49	FI-GP-38S-W101

 Materials / surface finishings: **W101** Steel, browned

STAUFF Press
Cloud connection allows preventive maintenance via remote access and facilitates the documentation of assembly processes
Type SPR-PRC-POC-A-A-IOT



Cutting ring assembly machines type SPR-PRC-POC are equipped at the factory with a built-in module for direct connection to a cloud operated by STAUFF. This solution is realised with an integrated SIM card which can be used in all industrial regions of the world.

Customers are given access to the cloud via a protected online portal, where they can get detailed information on the assembly processes performed, among other things.

This enables software updates, for example, without having to connect the machine to a local network on site. Parameter sets, which have been determined by STAUFF for non-standard tube materials can also be transferred quickly and directly to the machine in this way.

The required data security is guaranteed by encryption in both directions.

STAUFF Press
Optional tool holder for tubes with small bending radii
Type SPR-PRC-POC-RTH



The assembly head differs from the standard model by the holder for the cutting ring assembly socket being moved upwards, shortening the distance from the tube axis in the assembly socket to the upper edge of the machine from the standard 77 mm to 31 mm.

The optional assembly head enables tubes with a diameter of 6 to 18 mm in the Light Series and 6 mm to 16 mm in the Heavy Series to be handled.

This means that cutting rings can be fitted with ease to tubes with small axis distances.

Existing assembly tools can also continue to be used. The user simply needs to import new parameter sets into the machine.

If tubes with complex geometries are to be handled (e.g. with short tube end and 90° tail), the safety light barrier, which secures the assembly area, can be disabled if required.

P

Assembly Tool Magazine
Type SPR-TM



- Provides safe and convenient storage for up to 10 assembly studs (type FI-MFK) as well as up to 10 support plates (types FI-GP and FI-GP-PRC) for the machine-assisted cutting ring assembly
- Assembly studs and support plates are not included in the scope of delivery for this item and have to be ordered separately

External Foot Control Switch
Type SFO/PRC-POC-FS



- Enables the operator to trigger assembly processes from a larger distance to the machine (cable length: 7 m)



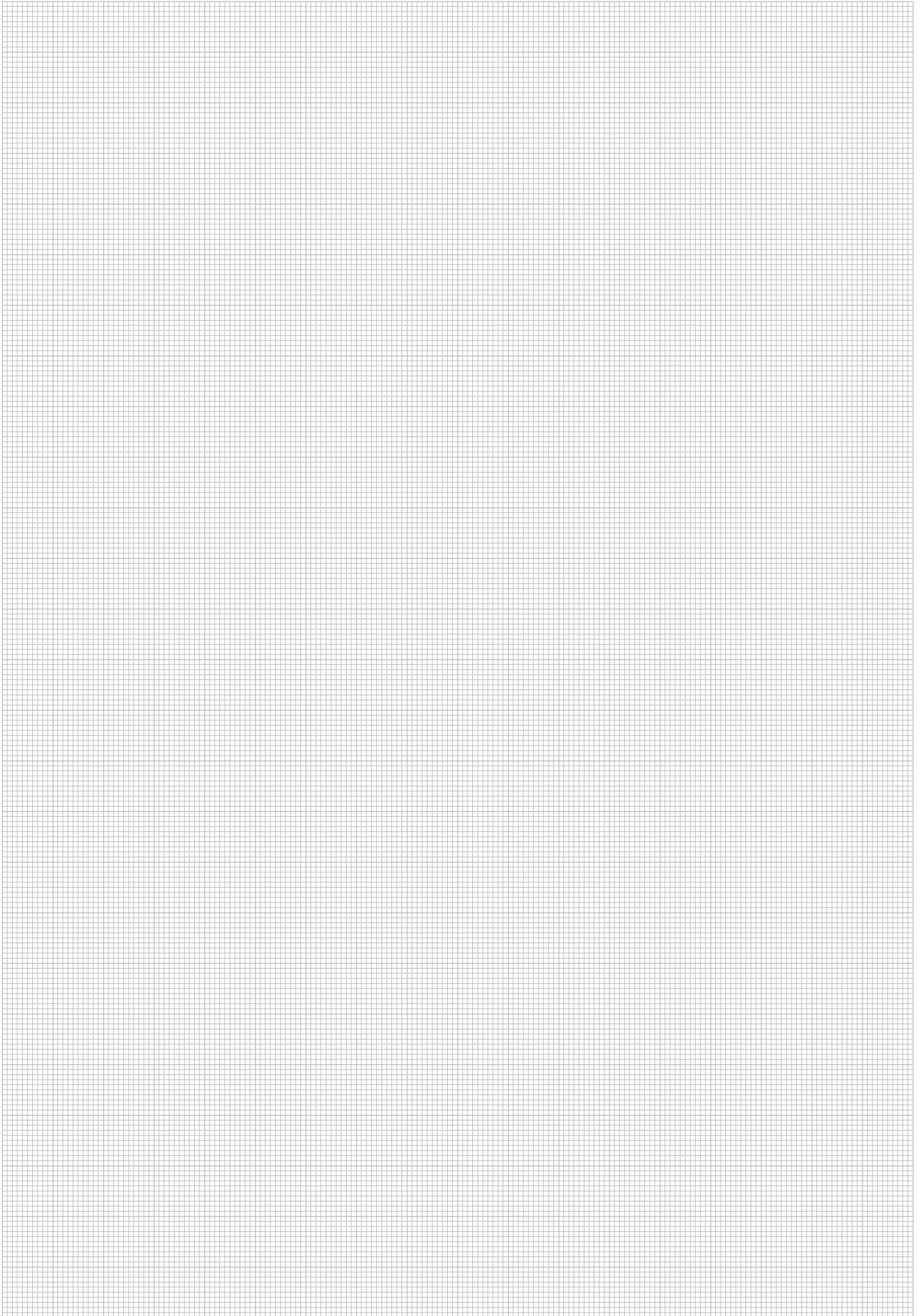

P



STAUFF Press Combined Cutting Ring Assembly and 37° Tube Flaring Machine with Automatic or Manual Pressure Setting and Control ▪ Type SPR-PRC-MA-D-A

Product Description

The electro-hydraulically operated STAUFF Press Assembly Machine SPR-PRC-MA-D-A allows the assembly of cutting rings in the Light Series (L) as well as in the Heavy Series (S) according to ISO 8434-1 / DIN 2353 on metric tube ends with outer diameters from 4 mm to 42 mm.

Exchangeable heads allows the device to be adapted for 37° flaring of metric and imperial tube ends with outer diameters from 4 mm and from 1/4 in to 1 1/2 in respectively according to DIN 3949 or SAE J514 / ISO 8434-2.

Short times for tool changes, setup and assembly (even when changing the assembly type from cutting ring assembly to 37° tube flaring) make it possible to carry out series production as well as the assembly of small and medium quantities with a high level of economic efficiency, reproducibility and process reliability with considerable reduction of times and cost of assembly of fittings.

The adjustable return stroke of the cylinder helps the operator to further optimise the total cycle times.

The machine is designed as a robust table-top device for continuous operation in the workshop. It is used in connection with hardened and wear-resistant assembly tools which are specially designed for the machine-assisted assembly.



Tooling head for cutting ring assembly based on pre-defined settings / automatic tool size detection



Tooling head for cutting ring assembly based on settings manually defined by the operator



Tooling head for 37° tube flaring based on settings manually defined by the operator



Smart programmable control panel with push/turn button and back-lit parameter display



Noise-reducing tool tray with durable rubber mat



Robust rubber feet providing secure positioning and dampening during operation



USB connection for maintenance and data input by the manufacturer



Electrical connection with a phase reversing plug according to IEC 60309 CEE 16A



Connections for the tool head as well as for the external foot control switch

P



STAUFF Press

Combined Cutting Ring Assembly and 37° Tube Flaring Machine with Automatic or Manual Pressure Setting and Control ▪ Type SPR-PRC-MA-D-A

Characteristics

Performance

- Pressure-controlled assembly of cutting rings on metric tube ends as well as 37° tube flaring of metric/imperial tube ends due to exchangeable tool heads
- Cutting ring assembly with Tooling Head SPR-PRC-TH-C-MA based on pre-defined pressure settings (with automatic tool size detection) or with Tooling Head SPR-PRC-TH-C-M based on pressure settings as manually defined by the operator
- Short times for tool and head changes, setup and assembly (even when changing the assembly type from cutting ring assembly to 37° tube flaring)
- Adjustable return stroke of the cylinder in order to further optimise the total cycle times
- Internal memory for up to 8 assembly programs which can be selected on the operating panel: predefined are tube materials steel E235 and E355 as well as stainless steel 316; parameters for other materials (copper, CuNiFe, Tungum, polyamide etc.) can be added by the manufacturer if required
- Counters for lot/batch sizes and total quantities
- Operator-friendly and easy to maintain and service

Design

- ① Robust and compact table-top device allowing for maximum mobility and flexibility
- ② Optimised assembly area with approx. 65 mm distance from the tube axis to the interfering edge of the machine housing, which allows processing of tubes with low bending radii or complex geometries
- ③ Noise-reducing tool tray with durable rubber mat
- ④ Lateral handle bars as attachment points for transport (e.g. with lifting belts)
- ⑤ Robust rubber feet providing secure positioning and dampening during operation
- ⑥ Type plate, with technical data, serial number, year of manufacture, etc.

Technical Data

Area of Application

- Function: Pressure-controlled assembly of cutting rings
Light (L): 6, 8, 10, 12, 15, 18, 22, 28, 35, 42 mm
Heavy (S): 6, 8, 10, 12, 14, 16, 20, 25, 30, 38 mm
- Pressure-controlled 37° flaring of metric tube ends (according to DIN 3949 bzw. SAE J 514 / ISO 8434-2):
Light (L): from 6 x 1 mm to 42 x 4 mm
Heavy (S): from 6 x 1 mm to 38 x 5 mm
- Pressure-controlled 37° flaring of imperial tube ends (according to SAE J 514 / ISO 8434-2):
1/4, 5/16, 3/8, 1/2, 5/8, 3/4, 7/8, 1, 1-1/4, 1-1/2 inch

Dimensions / Weight

- Dimensions (W x D x H): 660 mm x 515 mm x 265 mm with lateral handle bars (detachable)
- Distance from the tube axis to the interfering edge of the machine housing: 65 mm
- Clearance height: 30 mm (height of the machine feet)
- Weight (basic machine): 66 kg (incl. operating fluid, excl. assembly tools)
- Weight (tooling heads):
SPR-PRC-TH-C-A: 6,0 kg
SPR-PRC-TH-C-M: 5,5 kg
SPR-PRC-TH-F-M: 19,5 kg

Materials

- Machine frame: Steel
- Machine cover: Plastic
- Tool tray: NBR (Perbunan®)
- Machine feet: Natural rubber
- Assembly tools: Steel, uncoated, hardened

Operating Elements

- ⑦ Push/turn control button to select all relevant settings and assembly parameters
- ⑧ Smart programmable control panel with back-lit parameter display
- ⑨ Button for definite confirmation of entries made on the operating panel
- ⑩ Illuminated pushbutton to reset the cylinder and to indicate incorrect assemblies

Safety Devices

- ⑪ Selector switch to choose the operation mode (can be locked with a key and secured against unauthorised actuation, if required)
- ⑫ Main power switch
- ⑬ Separate emergency stop button to immediately stop all machine movements

Connections

- ⑭ Electrical connection according to IEC 60309 CEE 16A (cable length: 4 m)
- ⑮ USB connection for maintenance and data input by the manufacturer
- ⑯ Connections for tool heads for cutting ring assembly based on pre-defined pressure settings as well as for the external foot control switch SPR-PRC-FS (available on request)

Assembly Tools

- Tooling head SPR-PRC-TH-C-MA for cutting ring assembly based on automatic pressure setting (Pre-assembly is pre-defined) and with tool size detection via the support plates
- Tooling head SPR-PRC-TH-C-M for cutting ring assembly based on manual settings
- Tooling head SPR-PRC-TH-F-M for 37° tube flaring based on manual settings
- Wear-resistant cutting ring assembly stud FI-MFK
- Support plate FI-GP-...-PRC
- Clamping jaws FI-KB-...-PRC for 37° tube flaring

Motor Configuration

- Power supply: 400 V AC @ 50 Hz - 3 phases
- Current consumption: 2,8 A
- Connected load: 1,2 kW
- Electrical connection: Phase reversing plug according to IEC 60309 CEE 16A
- Cable length: 4 m

Alternative motor configurations and plug types are available on request. Please contact STAUFF for details.

Hydraulic System

- Operating fluid: Hydraulic oil Shell Nuto H 32 or equivalent (filled and ready for operation when delivered)
- Fluid volume: 4 litres
- Max working pressure: 200 bar

Operating Conditions

- Storage temperature: -10°C ... +70°C
- Ambient temperature: +10°C ... +50°C
- Ambient conditions: Dry, no condensing humidity, operation in horizontal position only
- Noise emission: less than 60 dB(A) as per EN ISO 11202



STAUFF Maintenance Contracts

Please contact STAUFF for a maintenance contract, that provides optimum service for your STAUFF assembly machine.



STAUFF Machine Rental

Please contact STAUFF for a rental machine and further details of what this service can offer.



Tooling Head for Cutting Ring Assembly (based on pre-defined settings) Type SPR-PRC-TH-C-MA



- Tooling head SPR-PRC-TH-C-MA for cutting ring pre-assembly based on pre-defined settings and with automatic tool size detection via the support plates
- Requires cutting ring assembly studs FI-MFK and support plates FI-GP-PRC

Tooling Head for Cutting Ring Assembly (based on manual settings) Type SPR-PRC-TH-C-M



- Tooling head SPR-PRC-TH-C-M for cutting ring pre-assembly based on manual settings
- Requires cutting ring assembly studs FI-MFK and support plates FI-GP-PRC

Tooling Head for 37° Tube Flaring (based on manual settings) Type SPR-PRC-TH-F-M



- Tooling head SPR-PRC-TH-F-M for 37° tube flaring based on manual settings
- Requires clamping jaws FI-KB-PRC

P

Assembly Tool Magazine Type SPR-TM



- Provides safe and convenient storage for up to 10 assembly studs (type FI-MFK) as well as up to 10 support plates (types FI-GP and FI-GP-PRC) for the machine-assisted cutting ring assembly
- Assembly studs and support plates are not included in the scope of delivery for this item and have to be ordered separately

External Foot Control Switch Type SPR-PRC-FS



- Enables the operator to trigger assembly processes from a larger distance to the machine (cable length: 5 m)



Cutting Ring Assembly Stud for Machine-Assisted Assembly Type FI-MFK • Series LL / L / S

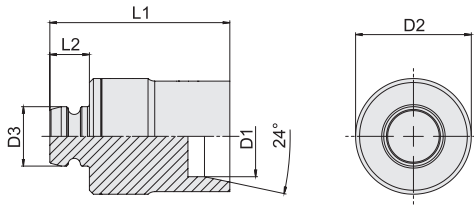

Series	Tube OD mm	Dimensions mm				Weight kg ca. per 100	Ordering Codes
		D1	D2	D3	L1		
L	6	30	14,8	50	10	13,57	FI-MFK-06L-W100
	8	30	14,8	50	10	14,01	FI-MFK-08L-W100
	10	30	14,8	50	10	14,63	FI-MFK-10L-W100
	12	30	14,8	50	10	16,09	FI-MFK-12L-W100
	15	30	14,8	50	10	16,63	FI-MFK-15L-W100
	18	30	14,8	50	10	18,23	FI-MFK-18L-W100
	22	30	14,8	49	10	19,13	FI-MFK-22L-W100
	28	33,8	14,8	48	10	24,43	FI-MFK-28L-W100
	35	42,8	14,8	45	10	32,72	FI-MFK-35L-W100
	42	49,8	14,8	44	10	41,17	FI-MFK-42L-W100
S	6	30	14,8	50	10	14,14	FI-MFK-06S-W100
	8	30	14,8	50	10	14,68	FI-MFK-08S-W100
	10	30	14,8	50	10	15,23	FI-MFK-10S-W100
	12	30	14,8	50	10	15,89	FI-MFK-12S-W100
	14	30	14,8	49	10	15,98	FI-MFK-14S-W100
	16	30	14,8	49	10	16,65	FI-MFK-16S-W100
	20	30	14,8	45	10	16,43	FI-MFK-20S-W100
	25	33,8	14,8	42	10	19,02	FI-MFK-25S-W100
	30	39,8	14,8	40	10	22,88	FI-MFK-30S-W100
	38	49,8	14,8	36	10	26,41	FI-MFK-38S-W100

Materials / surface finishings: **W100** Steel, PVD coated

Accessories



Cone Gauges

Page 283



Support Plate for Machine-Assisted Cutting Ring Assembly
Type FI-GP-PRC • Series L / S



Series	Tube OD mm	Ordering Codes
L	6	FI-GP-06L/S-PRC-MA-W1
	8	FI-GP-08L/S-PRC-MA-W1
	10	FI-GP-10L/S-PRC-MA-W1
	12	FI-GP-12L/S-PRC-MA-W1
	15	FI-GP-15L-PRC-MA-W1
	18	FI-GP-18L-PRC-MA-W1
	22	FI-GP-22L-PRC-MA-W1
	28	FI-GP-28L-PRC-MA-W1
	35	FI-GP-35L-PRC-MA-W1
	42	FI-GP-42L-PRC-MA-W1
S	6	FI-GP-06L/S-PRC-MA-W1
	8	FI-GP-08L/S-PRC-MA-W1
	10	FI-GP-10L/S-PRC-MA-W1
	12	FI-GP-12L/S-PRC-MA-W1
	14	FI-GP-14S-PRC-MA-W1
	16	FI-GP-16S-PRC-MA-W1
	20	FI-GP-20S-PRC-MA-W1
	25	FI-GP-25S-PRC-MA-W1
	30	FI-GP-30S-PRC-MA-W1
	38	FI-GP-38S-PRC-MA-W1

Materials / surface finishings: **W1** Steel, uncoated, hardened



Clamping Jaws for 37° Tube Flaring Type FI-KB • Series L / S



37° Flaring of Metric Tube Ends

Series	Tube OD mm	Ordering Codes		
		DIN 3949	SAE J514 / ISO 8434-2	
L	6	FI-KB-06L/S-PRC-MF-W1	FI-KB-06-PRC-F-W1	
	8	FI-KB-08L/S-PRC-MF-W1	FI-KB-08/5/16-PRC-F-W1	
	10	FI-KB-10L/S-PRC-MF-W1	FI-KB-10-PRC-F-W1	
	12	FI-KB-12L/S-PRC-MF-W1	FI-KB-12-PRC-F-W1	
	15	FI-KB-15L-PRC-MF/F-W1		
	18	FI-KB-18L-PRC-MF/F-W1		
	22	FI-KB-22L-PRC-MF/F-W1		
	28	FI-KB-28L-PRC-MF-W1	FI-KB-28-PRC-F-W1	
	35	FI-KB-35L-PRC-MF-W1	FI-KB-35-PRC-F-W1	
	42	FI-KB-42L-PRC-MF-W1	FI-KB-42-PRC-F-W1	
	S	6	FI-KB-06L/S-PRC-MF-W1	FI-KB-06-PRC-F-W1
		8	FI-KB-08L/S-PRC-MF-W1	FI-KB-08/5/16-PRC-F-W1
10		FI-KB-10L/S-PRC-MF-W1	FI-KB-10-PRC-F-W1	
12		FI-KB-12L/S-PRC-MF-W1	FI-KB-12-PRC-F-W1	
14		FI-KB-14S-PRC-MF/F-W1		
16		FI-KB-16S-PRC-MF-W1	FI-KB-16-PRC-F-W1	
20		FI-KB-20S-PRC-MF-W1	FI-KB-20-PRC-F-W1	
25		FI-KB-25S-PRC-MF-W1	FI-KB-25-PRC-F-W1	
30		FI-KB-30S-PRC-MF/F-W1		
30 x 5		FI-KB-30SX5-PRC-MF-W1	FI-KB-38/1-1/2-PRC-F-W1	
38		FI-KB-38S-PRC-MF-W1		
38 x 5		FI-KB-38SX5-PRC-MF-W1		

37° Flaring of Imperial Tube Ends

Tube OD mm	Ordering Codes
	SAE J514 / ISO 8434-2
1/4	FI-KB-1/4-PRC-F-W1
5/16	FI-KB-08/5/16-PRC-F-W1
3/8	FI-KB-3/8-PRC-F-W1
1/2	FI-KB-1/2-PRC-F-W1
5/8	FI-KB-5/8-PRC-F-W1
3/4	FI-KB-3/4-PRC-F-W1
7/8	FI-KB-7/8-PRC-F-W1
1	FI-KB-1-PRC-F-W1
1-1/4	FI-KB-1-1/4-PRC-F-W1
1-1/2	FI-KB-38/1-1/2-PRC-F-W1

Materials / surface finishings: **W1** Steel, uncoated, hardened



STAUFF Press Portable Cutting Ring Assembly Machine with Manual Pressure Setting (Set) Type SPR-PRC-H-E-SET

Product Description

With the battery-operated STAUFF Press Assembly Machine SPR-PRC-H-E-SET, STAUFF provides an ergonomically designed, light-weight and at the same time robust device for the assembly of cutting rings made of Carbon Steel and Stainless Steel in the Light Series (L) as well as in the Heavy Series (S) according to ISO 8434-1 / DIN 2353 on metric tube ends with outer diameters from 6 mm to 42 mm.

The machine has been designed for hand-held, tripod- or table-mounted operation and offers the best technical compromise between maximum flexibility, economic efficiency and a high level of process reliability with considerable reduction of time and cost for the assembly of cutting ring fittings.

Short tool change and setup times (with only a few seconds required to manually adjust the assembly pressure) make it possible to carry out the assembly of medium and even small quantities of cutting ring fittings, e.g. during maintenance, servicing, conversion and repair works on hydraulic pipe and tube systems. With the rechargeable battery being able to typically cover more than 200 assembly cycles per charge (depending on pressure settings and other influencing factors), the machine is also suitable for mass processing and production.

The assembly machine is by default supplied in a heavy-duty trolley transport case that is equipped with a range of accessories and also provides suitable space for the assembly studs.

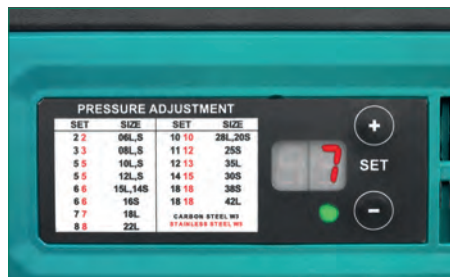

Operating element to adjust the pressure setting (settings indicated on the machine housing) incl. status lights



Assembly machine attached to a tripod stand using a mounting bracket



Heavy-duty trolley transport case



STAUFF Press Portable Cutting Ring Assembly Machine with Manual Pressure Setting (Set) Type SPR-PRC-H-E-SET

Technical Data

Area of Application

- Function: Pressure-controlled assembly of cutting rings made of Carbon Steel and Stainless Steel acc. to ISO 8434-1 / DIN 2353 on metric tube ends
Light (L): 6, 8, 10, 12, 15, 18, 22, 28, 35 and 42 mm
Heavy (S): 6, 8, 10, 12, 14, 16, 20, 25, 30 and 38 mm

Dimensions / Weight

- Dimensions (L x H x W): 440 mm x 330 mm x 80 mm
(including rechargeable battery)
- Weight (basic machine): 6,9 kg
(including rechargeable battery)
- Weight (case): 16,6 kg
(including assembly machine and accessories)
- Case: IP67 certified, equipped with o-ring seal and automatic pressure valve

Materials

- Machine cover: Plastic
- Tool head: Steel, uncoated, hardened
- Assembly studs: Stainless steel, hardened

List of Components

Set supplied in a heavy-duty trolley transport case:

- ① Light-weight and ergonomically designed cutting ring assembly machine for the hand-held, tripod-mounted or table-mounted operation
- ② Rechargeable battery
- ③ Additional replacement battery
- ④ Battery quick charging unit
- ⑤ Clips (to keep the assembly stud in position)
- ⑥ Assembly oil with brush (to lubricate the taper of the assembly stud)
- ⑦ Shoulder strap

Equipment to be ordered separately:

- ⑧ Cutting Ring Assembly Studs **FI-MVK-PRC-H-M-HR**

Spare Parts

- Assembly oil with brush **SPR-PRC-H-M-OS**
(required to lubricate the taper of the assembly stud)
- Rechargeable Battery **SPR-PRC-H-M-BP**
- Battery Quick Charging Unit **SPR-PRC-H-M-BC**

Rechargeable Battery

- Typically covers more than 200 assembly cycles per charge (depending on pressure settings and other influencing factors)
- Battery type: Lithium-ion (18V / 5.0 Ah)

Charging Unit

- Charging time for empty batteries is approximately 75 minutes
- Power supply: 230 V AC @ 50 Hz - single-phase
- Electrical connection: 2-pin grounded safety plug (CEE 7/4, type F / Schuko)
- Cable length: 1,10 m

Accessories



- Tripod Stand **SPR-PRC-H-M-TP**



- Table Stand **SPR-PRC-H-M-TS**



- Mounting Bracket **SPR-PRC-H-M-MH**
(required as a machine holder for both the tripod stand and the table stand)



Cutting Ring Assembly Stud for Machine-Assisted Assembly
Type FI-MVK-PRC-H-M ▪ Series L / S



Series	Tube OD mm	Ordering Codes
L	6	FI-MVK-06L-PRC-H-M-HR
	8	FI-MVK-08L-PRC-H-M-HR
	10	FI-MVK-10L-PRC-H-M-HR
	12	FI-MVK-12L-PRC-H-M-HR
	15	FI-MVK-15L-PRC-H-M-HR
	18	FI-MVK-18L-PRC-H-M-HR
	22	FI-MVK-22L-PRC-H-M-HR
	28	FI-MVK-28L-PRC-H-M-HR
	35	FI-MVK-35L-PRC-H-M-HR
	42	FI-MVK-42L-PRC-H-M-HR
S	6	FI-MVK-06S-PRC-H-M-HR
	8	FI-MVK-08S-PRC-H-M-HR
	10	FI-MVK-10S-PRC-H-M-HR
	12	FI-MVK-12S-PRC-H-M-HR
	14	FI-MVK-14S-PRC-H-M-HR
	16	FI-MVK-16S-PRC-H-M-HR
	20	FI-MVK-20S-PRC-H-M-HR
	25	FI-MVK-25S-PRC-H-M-HR
	30	FI-MVK-30S-PRC-H-M-HR
	38	FI-MVK-38S-PRC-H-M-HR

Materials / surface finishing: **HR** Stainless steel, hardened



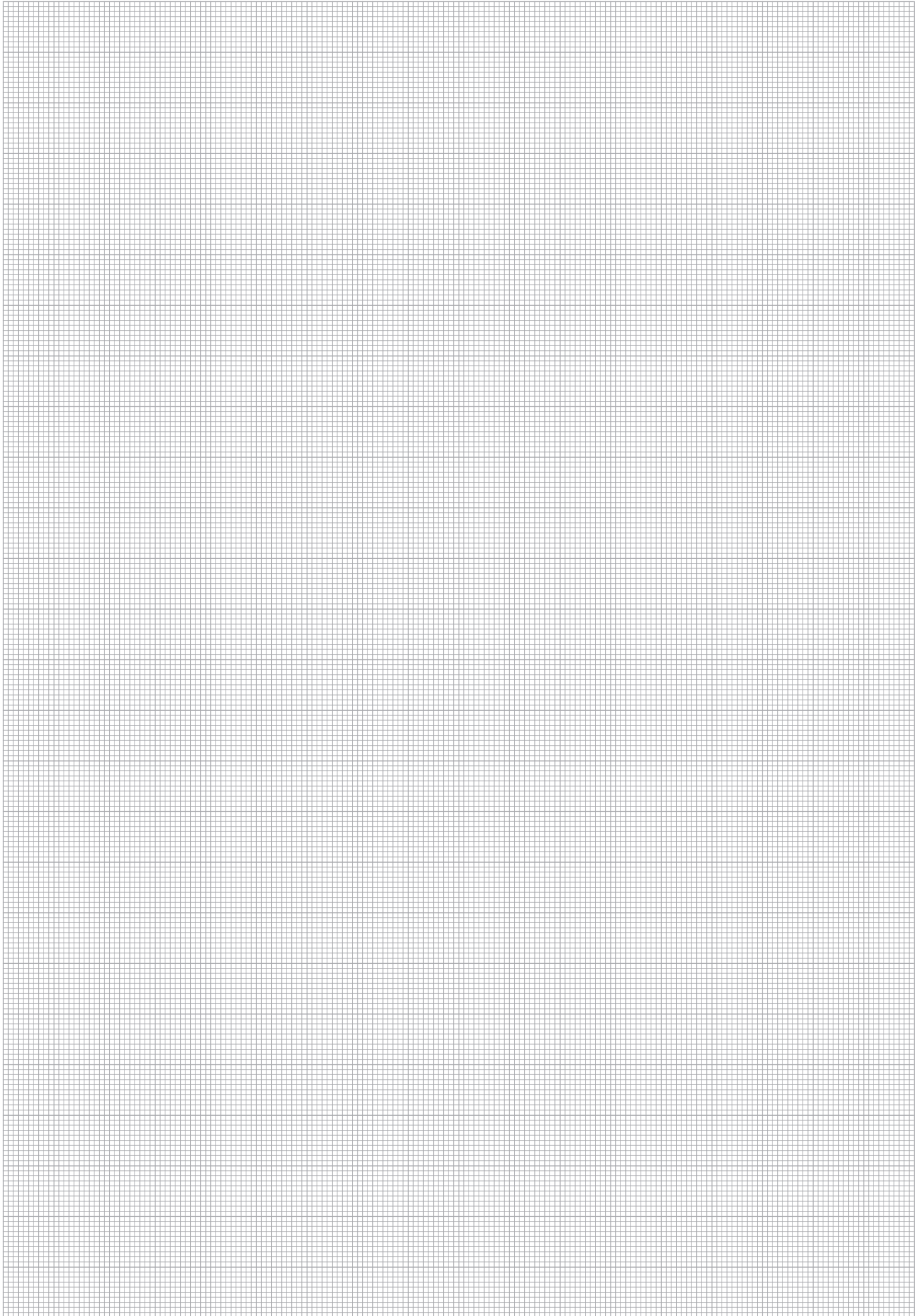

P



Manual Cutting Ring Pre-Assembly Device Type SPR-PRC-MP

Product Description

The manual cutting ring pre-assembly device can be used to pre-assemble hydraulic lines made of steel and stainless steel with an outer diameter of 6 - 42 mm.

For flexible use on site, the tool is supplied in a robust steel case. In the case there is also space for STAUFF cutting ring assembly studs type FI-MFK and support plates type FI-GP-PRC. These are not included in the scope of delivery, but can be purchased separately.



Product Features

- Pressure-controlled, manual assembly of steel and stainless steel cutting rings (ISO 8434-1 / DIN 2353) on metric tube ends from 6 to 42 mm in the light series and 6 to 38 mm in the heavy series
- For cutting rings of the FI-DS, FI-WDDS and FI-WDDS-W5 series
- Pressure values can be read on the device and precisely adjustable via manometer
- incl. robust steel case with storage space for accessories
- Ideally suited for flexible on-site use, e.g. for installation on the construction site without a power supply

Ordering Code

- Manual Cutting Ring Pre-Assembly Device

SPR-PRC-MP

Technical Data

- Dimensions W x D x H (incl. Case):
435,7 mm x 253 mm x 150 mm
(750 mm x 335 mm x 175 mm)
- Weight (incl. Case):
15 kg (23 kg)

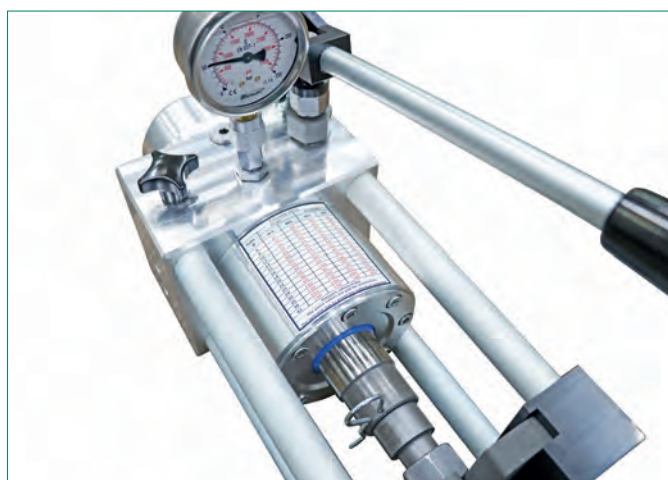
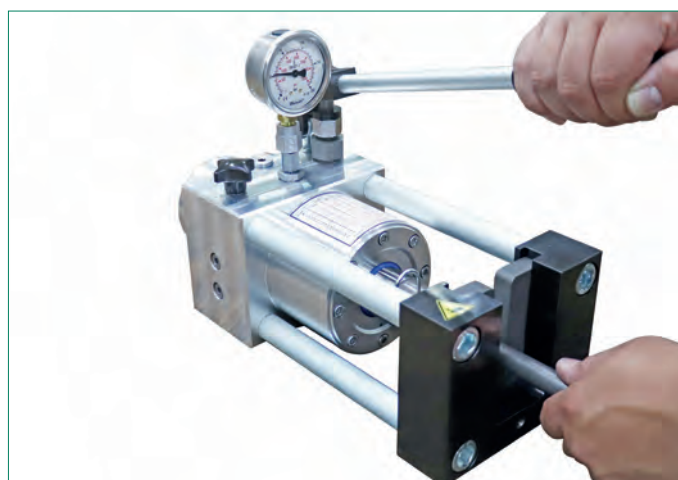

Cutting Ring Assembly Stud for Manual Assembly Type FI-MFK • Series LL / L / S

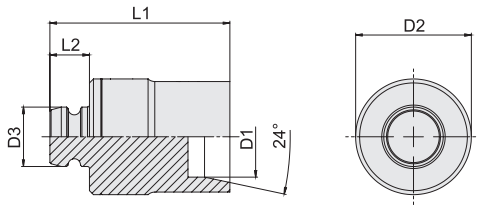

Series	Tube OD mm	Dimensions mm				Weight kg ca. per 100	Ordering Codes
		D1	D2	D3	L1		
L	6	30	14,8	50	10	13,57	FI-MFK-06L-W100
	8	30	14,8	50	10	14,01	FI-MFK-08L-W100
	10	30	14,8	50	10	14,63	FI-MFK-10L-W100
	12	30	14,8	50	10	16,09	FI-MFK-12L-W100
	15	30	14,8	50	10	16,63	FI-MFK-15L-W100
	18	30	14,8	50	10	18,23	FI-MFK-18L-W100
	22	30	14,8	49	10	19,13	FI-MFK-22L-W100
	28	33,8	14,8	48	10	24,43	FI-MFK-28L-W100
	35	42,8	14,8	45	10	32,72	FI-MFK-35L-W100
	42	49,8	14,8	44	10	41,17	FI-MFK-42L-W100
S	6	30	14,8	50	10	14,14	FI-MFK-06S-W100
	8	30	14,8	50	10	14,68	FI-MFK-08S-W100
	10	30	14,8	50	10	15,23	FI-MFK-10S-W100
	12	30	14,8	50	10	15,89	FI-MFK-12S-W100
	14	30	14,8	49	10	15,98	FI-MFK-14S-W100
	16	30	14,8	49	10	16,65	FI-MFK-16S-W100
	20	30	14,8	45	10	16,43	FI-MFK-20S-W100
	25	33,8	14,8	42	10	19,02	FI-MFK-25S-W100
	30	39,8	14,8	40	10	22,88	FI-MFK-30S-W100
	38	49,8	14,8	36	10	26,41	FI-MFK-38S-W100

Materials / surface finishings: **W100** Steel, PVD coated

Accessories



Cone Gauges

Page 283



Support Plate for Manual Cutting Ring Assembly
Type FI-GP-PRC • Series L / S



Series	Tube OD mm	Ordering Codes
L	6	FI-GP-06L/S-PRC-MA-W1
	8	FI-GP-08L/S-PRC-MA-W1
	10	FI-GP-10L/S-PRC-MA-W1
	12	FI-GP-12L/S-PRC-MA-W1
	15	FI-GP-15L-PRC-MA-W1
	18	FI-GP-18L-PRC-MA-W1
	22	FI-GP-22L-PRC-MA-W1
	28	FI-GP-28L-PRC-MA-W1
	35	FI-GP-35L-PRC-MA-W1
	42	FI-GP-42L-PRC-MA-W1
S	6	FI-GP-06L/S-PRC-MA-W1
	8	FI-GP-08L/S-PRC-MA-W1
	10	FI-GP-10L/S-PRC-MA-W1
	12	FI-GP-12L/S-PRC-MA-W1
	14	FI-GP-14S-PRC-MA-W1
	16	FI-GP-16S-PRC-MA-W1
	20	FI-GP-20S-PRC-MA-W1
	25	FI-GP-25S-PRC-MA-W1
	30	FI-GP-30S-PRC-MA-W1
	38	FI-GP-38S-PRC-MA-W1

Materials / surface finishings: **W1** Steel, uncoated, hardened



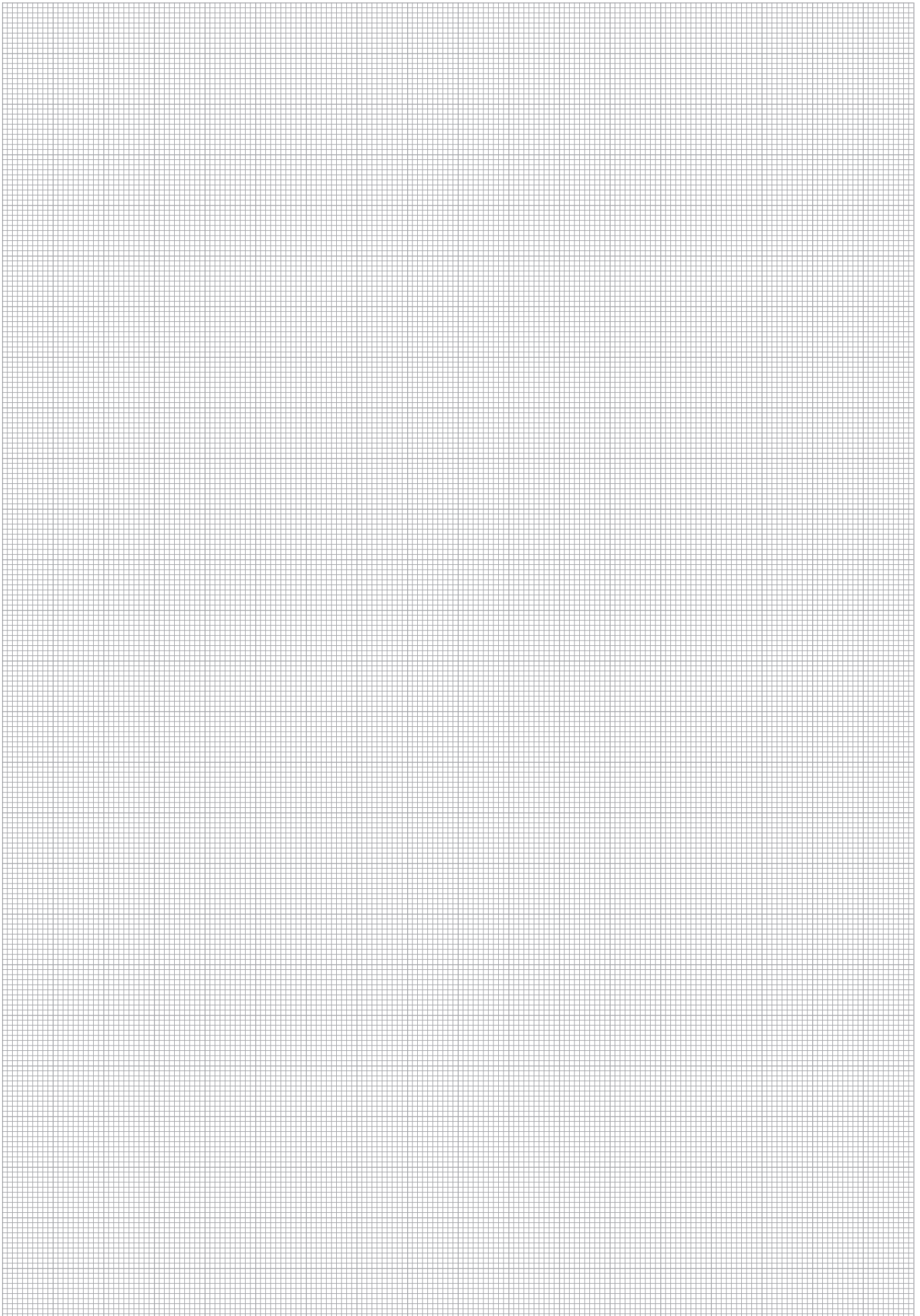

Final Assembly Stud for the Manual Cutting Ring Assembly Type FI-FK • Series LL / L / S

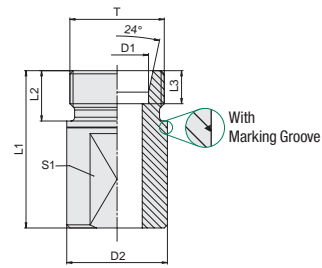
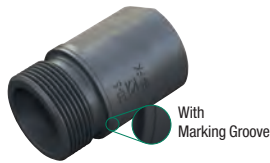

Series	Tube OD mm	Dimensions mm						Weight kg ca. per 100	Ordering Codes
		D1	Thread T	D2	L1	L2	L3		
LL	4	M 8 x 1	14	40	8	4	11	3,74	FI-FK-04LL-HR
	6	M 10 x 1	14	40	8	5,5	11	3,81	FI-FK-06LL-HR
	8	M 12 x 1	14	41	9	5,5	11	4,00	FI-FK-08LL-HR
L	6	M 12 x 1,5	14	43	10	7	11	4,21	FI-FK-06L-HR
	8	M 14 x 1,5	15	43	10	7	12	4,96	FI-FK-08L-HR
	10	M 16 x 1,5	17	44	11	7	14	6,57	FI-FK-10L-HR
	12	M 18 x 1,5	20	44	11	7	17	9,06	FI-FK-12L-HR
	15	M 22 x 1,5	23	45	12	7	19	12,34	FI-FK-15L-HR
	18	M 26 x 1,5	29	46	12	7,5	24	19,62	FI-FK-18L-HR
	22	M 30 x 2	32	48	14	7,5	27	25,11	FI-FK-22L-HR
	28	M 36 x 2	38	48	14	7,5	32	35,07	FI-FK-28L-HR
	35	M 45 x 2	48	60	16	10,5	41	69,87	FI-FK-35L-HR
	42	M 52 x 2	54	60	16	11	46	87,41	FI-FK-42L-HR
S	6	M 14 x 1,5	15	45	12	7	12	5,34	FI-FK-06S-HR
	8	M 16 x 1,5	17	45	12	7	14	6,92	FI-FK-08S-HR
	10	M 18 x 1,5	20	45	12	7,5	17	9,44	FI-FK-10S-HR
	12	M 20 x 1,5	22	45	12	7,5	17	10,87	FI-FK-12S-HR
	14	M 22 x 1,5	24	47	14	8	19	13,59	FI-FK-14S-HR
	16	M 24 x 1,5	27	48	14	8,5	22	17,49	FI-FK-16S-HR
	20	M 30 x 2	32	50	16	10,5	27	25,83	FI-FK-20S-HR
	25	M 36 x 2	38	62	18	12	32	46,15	FI-FK-25S-HR
30	M 42 x 2	44	64	20	13,5	36	62,34	FI-FK-30S-HR	
38	M 52 x 2	54	66	22	16	46	95,92	FI-FK-38S-HR	

Materials / surface finishings: HR Steel, uncoated, hardened

Accessories



Cone Gauges

Page 283

P

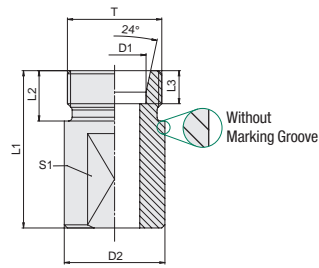

**Pre-Assembly Stud for the Manual Cutting Ring Assembly
Type FI-VK ▪ Series LL / L / S**

Series	Tube OD mm	Dimensions mm						Weight kg ca. per 100	Ordering Codes
		D1	Thread T	D2	L1	L2	L3		
LL	4	M 8 x 1	14	25	8	4,3	11	2,11	FI-VK-04LL-HR
	6	M 10 x 1	14	25	8	5,8	11	2,18	FI-VK-06LL-HR
	8	M 12 x 1	14	26	9	5,8	11	2,36	FI-VK-08LL-HR
L	6	M 12 x 1,5	14	28	10	7,3	11	2,57	FI-VK-06L-HR
	8	M 14 x 1,5	15	28	10	7,3	12	3,05	FI-VK-08L-HR
	10	M 16 x 1,5	17	29	11	7,3	14	4,07	FI-VK-10L-HR
	12	M 18 x 1,5	20	29	11	7,3	17	5,53	FI-VK-12L-HR
	15	M 22 x 1,5	23	30	12	7,3	19	7,75	FI-VK-15L-HR
	18	M 26 x 1,5	29	31	12	7,8	24	12,31	FI-VK-18L-HR
	22	M 30 x 2	32	33	14	7,8	27	16,08	FI-VK-22L-HR
	28	M 36 x 2	38	33	14	7,8	32	22,34	FI-VK-28L-HR
	35	M 45 x 2	48	45	16	10,8	41	49,40	FI-VK-35L-HR
S	6	M 14 x 1,5	15	30	12	7,3	12	3,43	FI-VK-06S-HR
	8	M 16 x 1,5	17	30	12	7,3	14	4,43	FI-VK-08S-HR
	10	M 18 x 1,5	20	30	12	7,8	17	5,92	FI-VK-10S-HR
	12	M 20 x 1,5	22	30	12	7,8	17	6,87	FI-VK-12S-HR
	14	M 22 x 1,5	24	32	14	8,3	19	8,74	FI-VK-14S-HR
	16	M 24 x 1,5	27	33	14	8,8	22	11,23	FI-VK-16S-HR
	20	M 30 x 2	32	35	16	10,8	27	16,83	FI-VK-20S-HR
	25	M 36 x 2	38	47	18	12,3	32	33,47	FI-VK-25S-HR
	30	M 42 x 2	44	49	20	13,8	36	45,62	FI-VK-30S-HR
	38	M 52 x 2	54	51	22	16,3	46	70,08	FI-VK-38S-HR

 Materials / surface finishings: **HR Steel**, uncoated, hardened

STAUFF Form EVO Tube Forming Machine Type SF0-F-A-A-IOT



Product Description

The type SF0-F-A-A-IOT tube forming machine facilitates the economical and most reliable production of tube ends made of steel, stainless steel and other materials with a contour typical for the STAUFF Form EVO tube forming system.

The machine is designed as a robust table-top device for continuous operation in the workshop. It is used in connection with FI-FST tube shapers and FI-FB clamping jaws. Tube shapers with FI-ID internal tube supports are used with selected tube dimensions, which prevent the tube from being constricted in the shaping area.

Tube shapers, clamping jaws and internal tube supports have been specifically designed for the mechanical forming process and can be quickly and simply replaced without the need for any tools, if required. The resulting short tool change and set-up times contribute to the high efficiency of the system as well as ensuring low cycle times.

All the tools needed for the forming process are clearly labelled with the tube dimensions so that assembly errors caused by incorrect assignment can be largely ruled out.



**STAUFF Form EVO Sealing Ring
Type FI-FD, see Page 32**

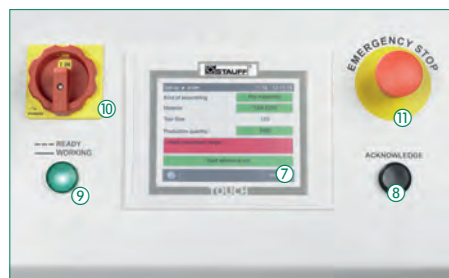

Operating elements of the tube forming machine



Noise-reducing tool tray with durable rubber mat



Lateral handle bars and rubber machine feet with suitable clearance height

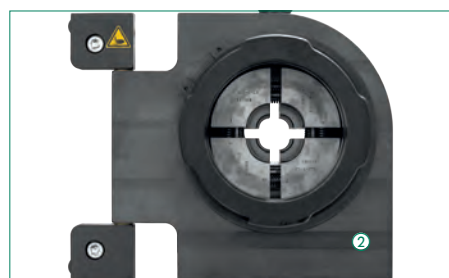

Open clamping head with clamping jaws inserted



Inserting the tube shaper into the tool holder – with no tools required



Electrical connections

Cloud connection allows preventive maintenance via remote access and facilitates the documentation of assembly processes



Tube forming machines type SF0-F-A are equipped at the factory with a built-in module for direct connection to a cloud operated by STAUFF. This solution is realised with an integrated SIM card which can be used in all industrial regions of the world.

This enables software updates, for example, without having to connect the machine to a local network on site. Parameter sets, which have been determined by STAUFF for non-standard tube materials can also be transferred quickly and directly to the machine in this way.

Customers are given access to the cloud via a protected online portal, where they can get detailed information on the assembly processes performed, among other things.

The required data security is guaranteed by encryption in both directions.



STAUFF Form EVO Tube Forming Machine Type SFO-F-A-A-IOT

Characteristics

Performance

- Constant high process safety, reliability and reproducibility by the position-control of the machine, which performs the shaping process following a manual start and monitors it by means of stored parameters
- Maximum efficiency thanks to short cycle times – ideal for series production
- Quick and simple replacement of tube shapers (with bayonet lock) and clamping jaws when changing the tube dimensions – with no tools required
- Potential risk of confusion and assembly errors caused by incorrect assignment can virtually be ruled out by the clear labelling of all assembly tools
- Surface-friendly clamping of the tube during the forming process
- Counters for lot/batch sizes and total quantities (separated by tool size)
- Predefined menu languages: English, German, French and Italian
- High degree of user comfort with clear information displayed on the operating panel

Design

- ① Robust and ergonomically designed machine housing
- ② Easily accessible clamping head for simple positioning of the clamping jaws and optimised assembly area with approx. 110 mm distance from the tube axis to the interfering edge of the machine housing, which allows processing of tubes with low bending radii or complex geometries
- ③ Noise-reducing tool tray with durable rubber mat
- ④ Lateral handle bars as attachment points for transport (e.g. with lifting belts)
- ⑤ Secure positioning thanks to flexible rubber machine feet
- ⑥ Type plate, with technical data, serial number, year of manufacture etc.

Technical Data

Area of Application

- Function: Cold forming of seamless cold drawn precision steel tubes acc. to to EN 10305-1 (materials E235, E355) and stainless steel tubes (material 1.4571 / AISI 316 Ti)

Parameters for alternative materials can be added by the manufacturer, if required. Please contact STAUFF for details.

- Operating principle: Tube forming with combined pressure/position-control
- Series and dimensions: Light Series (L): 6 x 1,5 mm to 42 x 4 mm
Heavy Series (S): 6 x 1,5 mm to 38 x 6 mm

Dimensions / Weight

- Dimensions (W x D x H): 850 mm x 890 mm x 330 mm with lateral handle bars (detachable)
- Distance from the tube axis to the interfering edge of the machine housing: 110 mm
- Clearance height: 65 mm (height of the machine feet) enables simple and safe transport using a forklift or pallet jack
- Weight: 210 kg (including operating fluid, excluding forming tools)

Materials

- Machine frame: Aluminium
- Machine housing: Steel, painted
- Tool tray: NBR (Perbunan®)
- Machine feet: Natural rubber
- Form rings: Steel, zinc/nickel-plated
- Form rings (seal): FKM (Viton®)

Operating Elements

- ⑦ Operating panel for display and selection of all relevant settings and forming parameters
- ⑧ Button for definite confirmation of entries made on the operating panel
- ⑨ Status light to indicate readiness for operation and running assembly processes

Safety Devices

- ⑩ Main power switch (can be secured against unauthorised actuation when required)
- ⑪ Separate emergency stop button to immediately stop all machine movements

Connections (at the back of the machine)

- ⑫ Electrical connection according to IEC 60309 CEE 16A (cable length: 4 m)
- ⑬ Connection for External Foot Control Switch Type SFO/PRC-POC-FS
- ⑭ Ethernet connection (RJ45) for maintenance and data input by the manufacturer
- ⑮ Aerial IoT Gateway for preventive maintenance via remote access and facilitates the documentation of assembly processes

Tube Forming Tools

- ⑯ Clamping Jaws FI-FB with clear identification of the tube dimension
- ⑰ Version of a Tube Shaper FI-FST with Internal Tube Support FI-ID
- ⑱ Tube Shaper FI-FST with clear identification of the tube dimensions

Motor Configuration

- Power supply: 400 V AC @ 50 Hz - 3 phases
460 V AC @ 60 Hz - 3 phases
- Current consumption: 2,55 A
- Connected load: 1,0 kW
- Electrical connection: Phase reversing plug according to IEC 60309 CEE 16A
- Cable length: 4 m

Alternative motor configurations and plug types are available on request. Please contact STAUFF for details.

Hydraulic System

- Operating fluid: Hydraulic oil Shell Tellus S2 MA 46 or equivalent (filled and ready for operation when delivered)
- Fluid volume: 6,1 litres
- Max working pressure: 700 bar

Operating Conditions

- Storage temperature: -10°C ... +70°C
- Ambient temperature: +15°C ... +35°C
- Ambient conditions: Dry, no condensing humidity, operation in horizontal position only less than 69 dB(A) as per EN ISO 11202 at full-load operation with maximum tube dimensions
- Noise emission:



STAUFF Maintenance Contracts

Please contact STAUFF for a maintenance contract, that provides optimum service for your STAUFF Tube Forming Machine.



STAUFF Machine Rental

Please contact STAUFF for a rental machine and further details of what this service can offer.



STAUFF Form EVO Tube Shapers ▪ Type FI-FST
STAUFF Form EVO Internal Tube Supports ▪ Type FI-ID



Tube OD mm	Tube Wall Thickness mm	Weight per piece kg ca.	Ordering Codes		
			Tube Shapers	Internal Tube Supports	
6	1,5	1,95	FI-FST-06L/S-F2-S-A		
8	1,5	1,97	FI-FST-08L/S-F2-S-A		
	2,0				
10	1,5	1,98	FI-FST-10L/S-F2-S-A		
	2,0				
	2,5				
	3,0				
12	1,5	1,99	FI-FST-12L/S-1.5-F2-S-A	FI-ID-12x1.5-HR/2	
	2,0		FI-FST-12L/S-2/2.5/3-F2-S-A		
	2,5				
	3,0				
15	1,5	2,0	FI-FST-15L-F2-S-A	FI-ID-15x1.5-HR/2	
	2,0			FI-ID-15x2.0-HR/2	
	2,5			FI-ID-15x2.5-HR/2	
16	2,0	2,04	FI-FST-16S-2/2.5-F2-S-A	FI-ID-16x2.0-HR/2	
	2,5		FI-FST-16S-3/4-F2-S-A	FI-ID-16x2.5-HR/2	
	3,0				
	4,0				
18	1,5	1,97	FI-FST-18L-2/2.5-F2-S-A	FI-ID-18x1.5-HR/2	
	2,0			FI-ID-18x2.0-HR/2	
	2,5			FI-ID-18x2.5-HR/2	
	3,0				
20	2,0	1,98	FI-FST-20S-2/2.5-F2-S-A	FI-ID-20x2.0-HR/2	
	2,5			FI-ID-20x2.5-HR/2	
	3,0				
	4,0				
22	2,0	1,95	FI-FST-22L-2/2.5-F2-S-A	FI-ID-22x2.0-HR/2	
	2,5			FI-ID-22x2.5-HR/2	
	3,0				
	3,5				
25	2,0	1,96	FI-FST-25S-2/2.5-F2-S-A	FI-ID-25x2.0-HR/2	
	2,5			FI-ID-25x2.5-HR/2	
	3,0			FI-FST-25S-3/3.5/4/5-F2-S-A	
	3,5				
	4,0				
	5,0				
28	2,0	1,96	FI-FST-28L-2/2.5/3-F2-S-A	FI-ID-28x2.0-HR/2	
	2,5			FI-ID-28x2.5-HR/2	
	3,0			FI-ID-28x3.0-HR/2	
	3,5				
	4,0				
30	2,5	1,95	FI-FST-30S-2.5/3-F2-S-A	FI-ID-30x2.5-HR/2	
	3,0			FI-ID-30x3.0-HR/2	
	4,0			FI-FST-30S-4/5/6-F2-S-A	
	5,0				
	6,0				
35	2,5	2,0	FI-FST-35L-2.5/3-F2-S-A	FI-ID-35x2.5-HR/2	
	3,0			FI-ID-35x3.0-HR/2	
	4,0			FI-FST-35L-4/5-F2-S-A	
	5,0				
38	3,0	1,82	FI-FST-38S-3/4-F2-S-A	FI-ID-38x3.0-HR/2	
	4,0			FI-ID-38x4.0-HR/2	
	5,0			FI-FST-38S-5/6-F2-S-A	
	6,0				
42	3,0	1,94	FI-FST-42L-F2-S-A	FI-ID-42x3.0-HR/2	
	3,5			FI-ID-42x3.5-HR/2	
	4,0			FI-ID-42x4.0-HR/2	

Materials / surface finishings: HR Steel, uncoated, hardened

Please note:

The selection chart is only applicable in conjunction with seamless cold drawn precision steel tubes according to EN 10305-1 (materials E235, E355) and stainless steel tubes (material 1.4571 / AISI 316 Ti).

Please consult STAUFF for information regarding the processing of tubes made from stainless steel and other materials.



STAUFF Form EVO Clamping Jaws ▪ Type FI-FB

Tube OD	Series	Weight per piece	Ordering Codes
mm		kg ca.	
6	L / S	2,37	FI-FB-06L/S-F2-S-A
8	L / S	2,36	FI-FB-08L/S-F2-S-A
10	L / S	2,32	FI-FB-10L/S-F2-S-A
12	L / S	2,30	FI-FB-12L/S-F2-S-A
15	L	2,37	FI-FB-15L-F2-S-A
16	S	2,31	FI-FB-16S-F2-S-A
18	L	2,28	FI-FB-18L-F2-S-A
20	S	2,24	FI-FB-20S-F2-S-A
22	L	2,32	FI-FB-22L-F2-S-A
25	S	2,17	FI-FB-25S-F2-S-A
28	L	2,32	FI-FB-28L-F2-S-A
30	S	2,05	FI-FB-30S-F2-S-A
35	L	1,92	FI-FB-35L-F2-S-A
38	S	1,92	FI-FB-38S-F2-S-A
42	L	1,77	FI-FB-42L-F2-S-A

**Overview tube dimensions
Parameter and Tools STAUFF Form EVO**
Carbon Steel

Size	Wallthickness								
	1	1,5	2	2,5	3	3,5	4	5	6
	E235/ E355	E235/ E355	E235/ E355	E235/ E355	E235/ E355	E235/ E355	E235/ E355	E235/ E355	E235/ E355
6	-	-	-	-	-	-	-	-	-
8	-	-	-	-	-	-	-	-	-
10	-	-	-	-	-	-	-	-	-
12	-	▪	-	-	-	-	-	-	-
15	-	▪	▪	▪	-	-	-	-	-
16	-	-	▪	▪	-	-	-	-	-
18	-	-	▪	▪	-	-	-	-	-
20	-	-	▪	▪	-	-	-	-	-
22	-	-	▪	▪	-	-	-	-	-
25	-	-	▪	▪	-	-	-	-	-
28	-	-	▪	▪	▪	-	-	-	-
30	-	-	-	▪	▪	-	-	-	-
35	-	-	-	▪	▪	-	-	-	-
38	-	-	-	-	▪	-	▪	-	-
42	-	-	-	-	▪	▪	▪	-	-

Parameter set and tools available. To use without tube supports.

Stainless Steel

Wallthickness	Size								
	1	1,5	2	2,5	3	3,5	4	5	6
	316ti	316ti	316ti	316ti	316ti	316ti	316ti	316ti	316ti
-	-	-	-	-	-	-	-	-	-
-	-	-	-	-	-	-	-	-	-
-	-	-	-	-	-	-	-	-	-
-	-	▪	-	-	-	-	-	-	-
-	-	▪	▪	-	-	-	-	-	-
-	-	▪	▪	-	-	-	-	-	-
-	-	▪	▪	-	-	-	-	-	-
-	-	▪	▪	-	-	-	-	-	-
-	-	▪	▪	-	-	-	-	-	-
-	-	▪	▪	▪	-	-	-	-	-
-	-	-	-	▪	▪	-	-	-	-
-	-	-	-	▪	▪	-	-	-	-
-	-	-	-	-	▪	-	▪	-	-
-	-	-	-	-	▪	-	▪	-	-
-	-	-	-	-	-	▪	-	-	-
-	-	-	-	-	-	▪	-	-	-

Parameter set and tools available. To use with internal tube supports.



External Foot Control Switch
Type SFO/PRC-POC-FS



- Enables the operator to trigger assembly processes from a larger distance to the machine (cable length: 7 m)

STAUFF Form EVO Oil
Type Oel-Stauff-Form-1L



- Enables faultless, mechanical tube forming with STAUFF Form EVO machines when using stainless steel tubes

STAUFF Oil with brush
Type SPR-PRC-H-M-OS



- Enables faultless, mechanical tube forming with STAUFF Form EVO machines when using stainless steel tubes



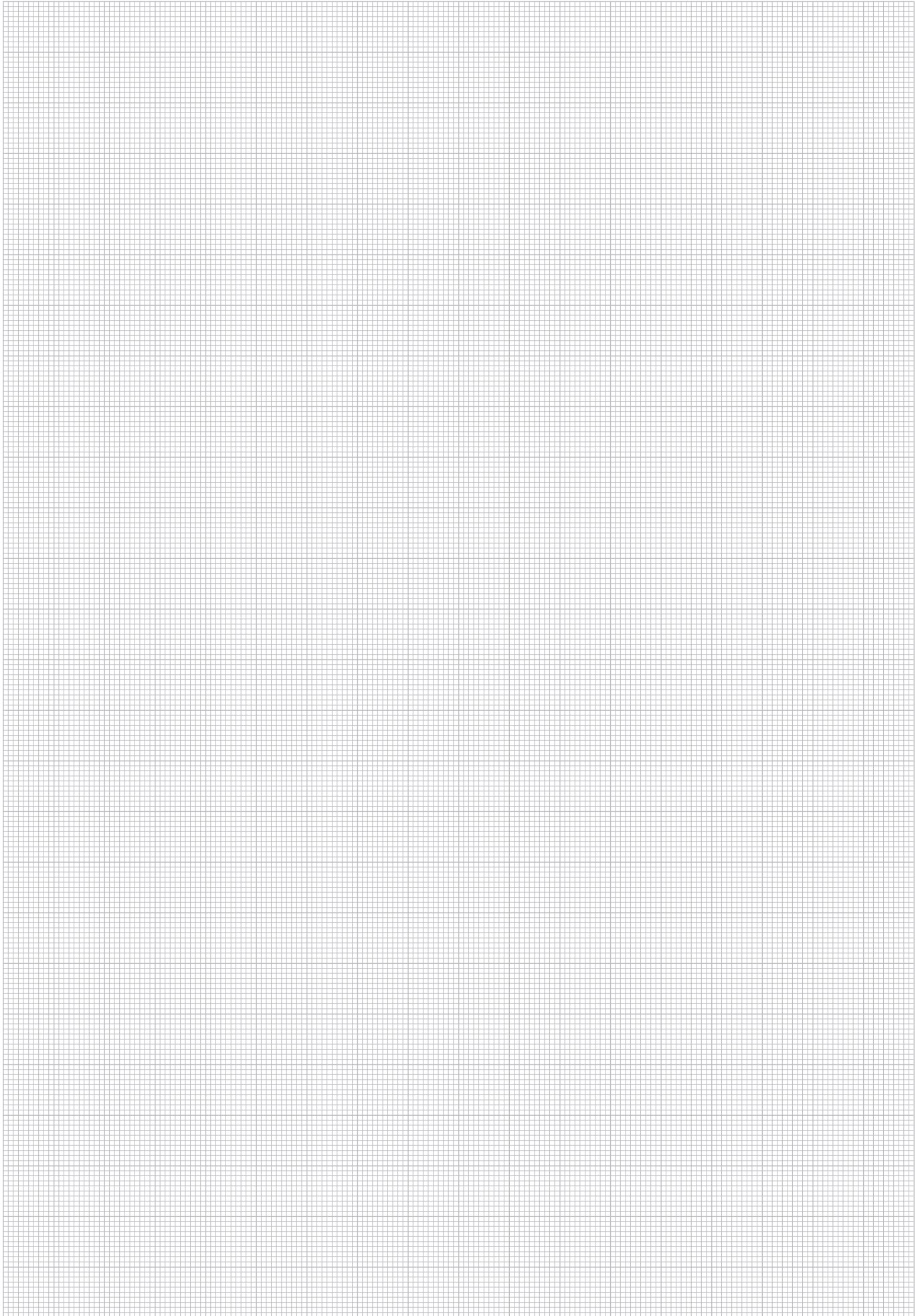

P



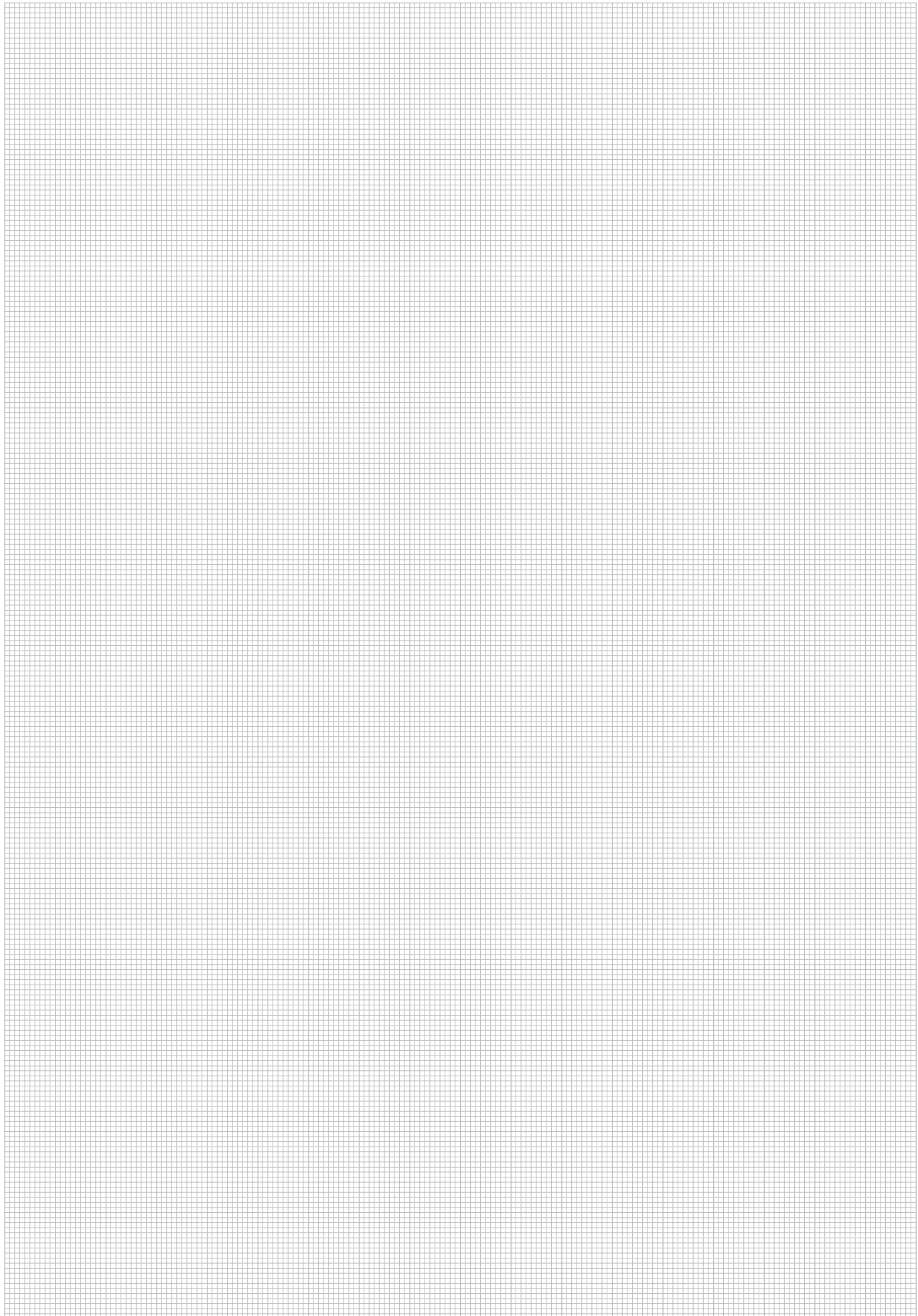

P



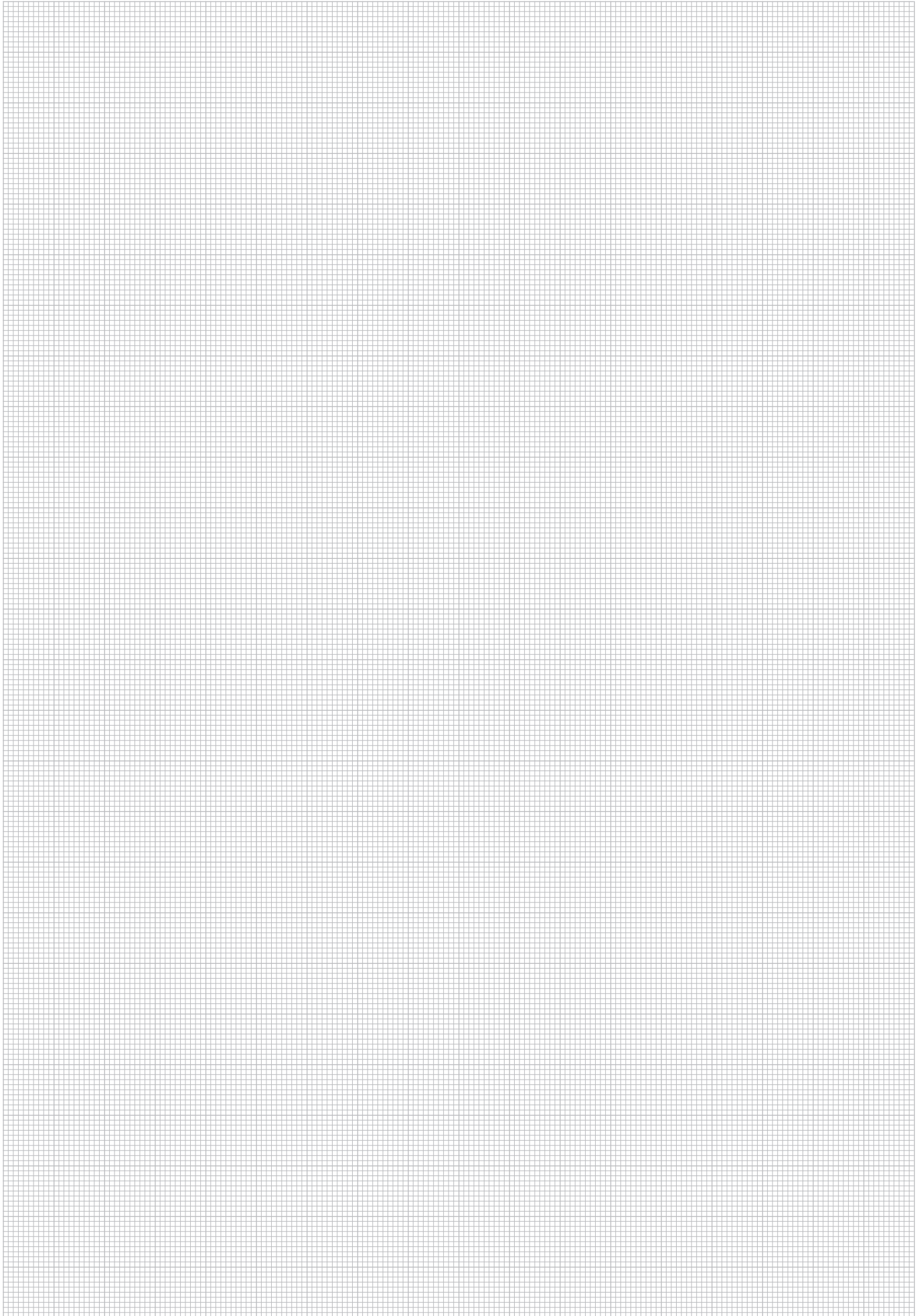

P







Thread Identification Board

FI-TIB

276



Cone Gauges

FI-KOL

277



Thread Identification Board Type FI-TIB

Product Description

The STAUFF Thread Identification Board is intended to be used as a universal tool for workshops, warehouses or sales counters allowing quick and easy determination of common thread types and sizes, e.g. for male stud tube connectors and test couplings.

The board is available in two different versions:

FI-TIB-M/G

13 Metric Parallel Threaded Ports

M8 x 1 / M10 x 1 / M12 x 1,5 / M14 x 1,5 /
M16 x 1,5 / M18 x 1,5 / M20 x 1,5 / M22 x 1,5 /
M26 x 1,5 / M27 x 2 / M33 x 2 / M42 x 2 / M48 x 2

8 Whitworth Parallel Pipe Threaded Ports

G1/8 / G1/4 / G3/8 / G1/2 / G3/4 / G1 / G1 1/4 / G1 1/2

FI-TIB-N/U

8 National Pipe Threaded Ports

1/8–27 NPT / 1/4–18 NPT / 3/8–18 NPT /
1/2–14 NPT / 3/4–14 NPT / 1–11.5 NPT /
1 1/4–11.5 NPT / 1 1/2–11.5 NPT

9 UNF/UN Threaded Ports

7/16–20 UNF / 1/2–20 UNF / 9/16–18 UNF /
3/4–16 UNF / 7/8–14 UNF / 1 1/16–12 UN /
1 5/16–12 UN / 1 5/8–12 UN / 1 7/8–12 UN



Product Features

- Covering all relevant thread type and sizes of male stud tube connectors and test couplings
- Boards made of hardened quality steel
- Finished with an extremely resistant cathodic electrodeposition coating
- Laser markings indicating the thread types and sizes next to the threaded ports
- Non-slip rubber feet providing good stability

Technical Data

- Dimensions (W x D x H): 275 mm x 190 mm x 31 mm
- Clearance height: 13 mm (height of the rubber feet)
- Weight: 6,0 kg

Note

Thread identification boards are intended to be tools for the basic determination of thread types and sizes. They do not replace high-precision thread gauges and measurement devices (should these become necessary at any point).

Q

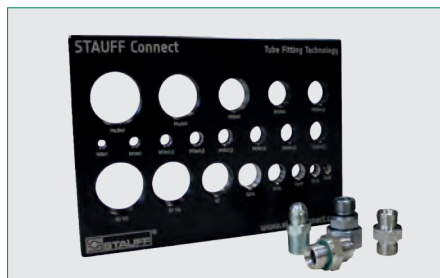

Cone Gauges Type FI-KOL

Product Description

These cone gauges are designed for wear checks on the 24° cone for all STAUFF final assembly studs 6 - 42 mm. To ensure accuracy during cutting ring assembly, the assembly stud has to be checked for wear and damage after max. 50 assembly processes (DIN 3859-2).

This set is suitable for all final assembly studs of type FI-MFK as well as for manual assembly cones of type FI-FK.

The cone gauges are available individually or as a complete set for all sizes in a convenient case.

Product Features

- Ensure accurate cutting ring assembly because the target cone in the stud can be verified with precision
- Prevents premature replacement of the studs
- Easy handling

Technical Data

- Dimensions Case (W x D x H):
357 mm x 305 mm x 80 mm
- Dimensions Cone Gauges (H)
95 mm



Ordering Code

- Cone Gauge Kit in Box (Size 6 to 42)

FI-Box-Cone-Gauge-Kit-6-42

Single Cone Gauges

Size	Ordering Codes
06L/S	FI-KOL-06L/S-W1
08L/S	FI-KOL-08L/S-W1
10L/S	FI-KOL-10L/S-W1
12L/S	FI-KOL-12L/S-W1
14S	FI-KOL-14S-W1
15L	FI-KOL-15L-W1
16S	FI-KOL-16S-W1
18L	FI-KOL-18L-W1
20S	FI-KOL-20S-W1
22L	FI-KOL-22L-W1
25S	FI-KOL-25S-W1
28L	FI-KOL-28L-W1
30S	FI-KOL-30S-W1
35L	FI-KOL-35L-W1
38S	FI-KOL-38S-W1
42L	FI-KOL-42L-W1







STAUFF Clean
Pipe, Tube and Hose Cleaning System
SC

282



Manual Tube Bender
TUB-MA

284



Tube Bending and Saw Device
TUBSD-MA

285



Tube Saw Device
TUSD-MA

286



Tube Reamer
TUD-MA

287



STAUFF Clean Pipe, Tube and Hose Cleaning System

Product Description

The STAUFF Clean System comprises of a pneumatic launcher and a range of specially designed nozzles and projectiles.

The launcher uses standard industrial compressed air pressure between 6 and 8 bar to propel a foam projectile through the nozzle and into the pipe, tube or hose bore to have their inside surface cleaned from any unwanted contamination.

This provides a safe and environmentally friendly tool that requires little formal expertise to operate and apply.

The **launcher** is the part of the system that controls the air supply to propel the projectile from start to finish of the cleaning job.

The **nozzles** are specially designed to affect an airtight seal on any pipe, tube or hose with or without end fittings. Its main purpose is to compress the foam projectile allowing it to enter the internal diameter of the pipe, tube or hose to be cleaned.

The **projectile** is the part of the system that does the cleaning: The foam projectile is sized to be approximately 15% larger than the internal diameter of the pipe, tube or hose to be cleaned. The compression of the projectile against the internal wall cleans the internal surface and expels any loose contaminants from the end of the pipe, tube or hose.

The STAUFF Clean System is available as separate components or in a variety of kit forms comprising various nozzle types, adaptor and launcher, all contained in a heavy duty carrying case.



R

STAUFF Clean Launchers / Launcher Kits



Characteristics

- Pneumatic pistol-grip launcher
- Light-weight and ergonomic design
- Easy to operate and apply
- Connection to air supply with quick release coupling
- Suitable for any type of nozzle
- Delivered separately or in a variety of kit forms including carrying case, adaptor ring and nozzles (if required)

Technical Data

- Air compressor requirement: 6 ... 8 bar
- Effective air volume: 250 ... 400 l/min

Ordering Codes

- Launcher only **SC-LG**
- Launcher kit (launcher, kit and adaptor) **SC-LK**
- Kit (as above) with set of 10 Universal nozzles **SC-10UV-K**
- Kit (as above) with set of 18 Metric Tube nozzles **SC-18MT-K**
- Kit (as above) with set of 10 JIC nozzles **SC-10J-K**
- Kit (as above) with set of 7 BSP nozzles **SC-7B-K**
- Kit (as above) with set of 7 NPT nozzles **SC-7N-K**

Contact STAUFF for alternative connection adaptors and couplings.



**STAUFF Clean
Nozzles / Nozzle Sets**
Universal Nozzle Set (SC-U-SET)

The Universal Nozzle is designed with a tapered seat that will allow it to suit for 90% of applications, including Hose, Tube and Pipe, with or without fittings, in hydraulic and pneumatic pipe systems, condenser tubes, boiler tubes and food lines.

The Universal Nozzle kit fits all and will accommodate applications with JIC, SAE and BSP end fittings.

The set of 10 nozzles consists of the following sizes: 6 mm, 8 mm, 10 mm, 13 mm, 16 mm, 19 mm, 25 mm and 32 mm.

JIC Nozzle Set (SC-J-SET)

The JIC Nozzle is designed specifically for use with JIC and SAE type fittings. The nozzles are machined to accommodate both male and female configuration, ensuring a perfect airtight seal every time.

The set of 10 nozzles consist of the following sizes: 6 mm, 8 mm, 10 mm, 13 mm, 16 mm, 19 mm, 25 mm, 32 mm, 38 mm and 50 mm.

Metric Tube Nozzle Set (SC-M-SET)

The Metric Tube Nozzle is intended for use specifically with Metric sized tube and is designed to fit over the outside of the tube or pipe being cleaned.

The inside diameter of the nozzle is reduced to match the inside diameter of the tube. The nozzles are machined from solid bar stock and designed for superior strength.

The set of 18 nozzles consist of the following sizes: 6 mm, 8 mm, 10 mm, 12 mm, 14 mm, 15 mm, 16 mm, 18 mm, 20 mm, 22 mm, 25 mm, 28 mm, 30 mm, 35 mm, 38 mm, 42 mm, 50 mm and 60 mm.

BSP Nozzle Set (SC-B-SET)

The BSP Nozzle is designed specifically for BSP configuration fittings. The nozzles are machined to accommodate both male and female configurations, ensuring a perfect airtight seal every time.

The set of 7 nozzles consist of the following sizes: 6 mm, 10 mm, 13 mm, 16 mm, 19 mm, 25 mm and 32 mm.



Adaptor Ring for Nozzels (SCN-AR)
Required for sizes 6-32 mm / 1/4-1 1/4 in

If required, nozzles can be supplied separately. Contact STAUFF for details.

NPT Nozzle Set (SC-N-SET)

The NPT Nozzle is designed specifically for NPT configuration fittings. The nozzles are machined to accommodate both male and female configurations, ensuring a perfect airtight seal every time.

The set of 7 nozzles consist of the following sizes: 1/4 in, 3/8 in, 1/2 in, 5/8 in, 3/4 in, 1 in and 1 1/4 in.

**STAUFF Clean
Projectiles**
Coupling Series (SCP-C)

Intended for the cleaning of hose assemblies (hose with end fittings, adjustments, etc.) or the removal of loose contamination from pipe, tube or hose.

Abrasive Series (SCP-A)

Intended for the internal cleaning of metal pipe and tube to remove light contaminants (rust and scale). They are recognised by the shorter abrasive pad fixed to one end of the projectile.

Grinding Series (SCP-G)

Intended for the internal cleaning of metal pipe and tube to remove medium and heavy contamination (rust and scale) from the internal surface. They are recognised by the longer abrasive pad fixed to one end of the projectile that is coated in Silicon Carbide.



Size	Pipe / Tube / Hose ID		Ordering Codes		
	(mm)	(in)	Coupling Series (SCP-C)	Abrasive Series (SCP-A)	Grinding Series (SCP-G)
07	4,8	3/16	SCP-C-07	SCP-A-07	SCP-G-07
09	6,4	1/4	SCP-C-09	SCP-A-09	SCP-G-09
10	6,4	1/4	SCP-C-10	SCP-A-10	SCP-G-10
12	7,9	5/16	SCP-C-12	SCP-A-12	SCP-G-12
14	9,5	3/8	SCP-C-14	SCP-A-14	SCP-G-14
16	11,1	7/16	SCP-C-16	SCP-A-16	SCP-G-16
18	12,7	1/2	SCP-C-18	SCP-A-18	SCP-G-18
20	14,3	9/16	SCP-C-20	SCP-A-20	SCP-G-20
22	15,9	5/8	SCP-C-22	SCP-A-22	SCP-G-22
26	19,1	3/4	SCP-C-26	SCP-A-26	SCP-G-26
28	20,6	13/16	SCP-C-28	SCP-A-28	SCP-G-28
30	22,2	7/8	SCP-C-30	SCP-A-30	SCP-G-30
33	25,4	1	SCP-C-33	SCP-A-33	SCP-G-33
36	26 / 27	1 1/16	SCP-C-36	SCP-A-36	SCP-G-36
38	28,6	1 1/8	-	SCP-A-38	SCP-G-38
40	31,8	1 1/4	SCP-C-40	SCP-A-40	SCP-G-40
45	34,9	1 3/8	SCP-C-45	SCP-A-45	SCP-G-45
50	38,1	1 1/2	SCP-C-50	SCP-A-50	SCP-G-50
55	44,5	1 3/4	SCP-C-55	SCP-A-55	SCP-G-55
60	50,8	2	SCP-C-60	SCP-A-60	SCP-G-60

Please note: For optimum cleaning, it is recommended that projectiles are used once and then discarded and disposed of in an appropriate way.

Safety note: A mesh collection bag should be secured to the pipe, tube or hose exit to avoid possible injury to personnel by the projectile exiting at high velocity.

Always wear protective safety glasses, ear protection and a dust mask when operating this system.

R

Manual Tube Bender Typ TUB-MA

Product Description

When used with a commercially available vice, STAUFF manual tube benders, type TUB-MA, enable common hydraulic tubes to be bent manually.

They are suitable for steel and stainless steel tubes with diameters of 6, 8, 10, 12, 14, 15, 16, 18 and 22 mm with a defined minimum wall thickness.

In addition to the metric version, a model for handling inch-gauge tubes with diameters of between 1/4 and 7/8 inches is also available.

The eight bending rollers – six in the imperial version – ensure maximum wear.

A scale lasered onto the bending rollers enhances the accuracy of the required bending angle with superior precision.

The manual tube bender is supplied with all the necessary components and multilingual instructions for use as a complete kit in a high-quality steel case.

Product Features

- Small bending radii allow for compact assemblies
- Optimised bending contour, which enables tube bends free of flattening and constriction
- hard wearing steel bending rolls
- ideal for versatile site use, possibly for installation work on site

Technical Data

- Dimensions (W x D x H):
640 mm x 165 mm x 70 mm
- Weight (incl. Case):
Metric Version 13,8 kg
Imperial Version 12,1 kg



Ordering Codes

- Manual Tube Bender Set in Steelcase (metric Version) **TUB-MA-M622-LV-KIT**
- Manual Tube Bender Set in Steelcase (imperial Version) **TUB-MA-I4140D-LV-KIT**

Spare Parts / Accessories

Description	Ordering Codes
Bending Lever	TUB-MA-S-Bending-Lever
Baseplate	TUB-MA-S-Baseplate
Guide Roller	TUB-MA-S-Guide-Roller-W32
Hold Roll	TUB-MA-S-Hold-Roll-W101
Guide Roller Mount	TUB-MA-S-Guide-Roller-Mount
Bolt	TUB-MA-S-Bolt-M12x32
Pivot Pin	TUB-MA-S-Pivot-Pin
Bending Lever Support	TUB-MA-S-Bending-Lever-Support-W32
Bending Roller 6/8 mm	TUB-T-BE-M6/8-MIOD-W32
Bending Roller 10 mm	TUB-T-BE-M10-MIOD-W32
Bending Roller 12 mm	TUB-T-BE-M12-M622-W32
Bending Roller 14/15 mm	TUB-T-BE-M14/15-M622-W32
Bending Roller 16 mm	TUB-T-BE-M16-MIOD-W32
Bending Roller 18 mm	TUB-T-BE-M18-M622-W101
Bending Roller 20 mm	TUB-T-BE-M20-M622-W101
Bending Roller 22 mm	TUB-T-BE-M22-MIOD-W101
Bending Roller 1/2"	TUB-T-BE-080D-I4140D-W32
Bending Roller 3/4"	TUB-T-BE-120D-I4140D-W101

Parts assignment: www.stauff.com/en/category/025000/025022/025025/025021B



Outer Diameter	Metric	Inch	Radius	Minimum Wall Thickness
6/8 mm (1/4" / 5/16")	•	•	33 mm / 1.30 in	1,5 mm / .06 in
10 mm (3/8")	•	•		
12 mm	•	•		1,5 mm / .06 in
1/2"		•	40 mm / 1.57 in	2,0 mm / .08 in
14 mm	•			1,5 mm / .06 in
15 mm	•			1,5 mm / .06 in
16 mm (5/8")	•	•	48 mm / 1.89 in	1,5 mm / .06 in
18 mm	•			2,0 mm / .08 in
3/4"		•		1,5 mm / .06 in
20 mm	•			2,0 mm / .08 in
22 mm (7/8")	•	•		2,0 mm / .08 in

R



Tube Bending and Saw Device Type TUBSD-MA

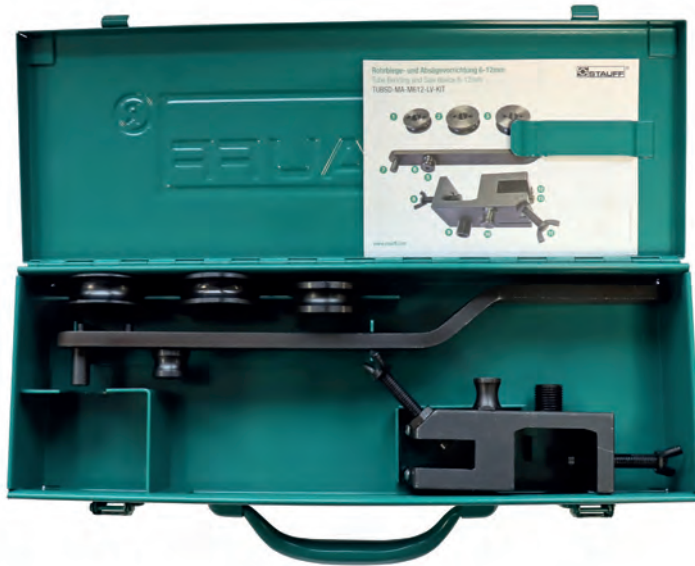

Product Description

This sturdy steel case is designed for short-term use on the go, providing all components required for bending and sawing off hydraulic tubes made of steel or stainless steel. The case contains a combined manual tube bending and sawing device which can be attached with a standard vice or directly to a work-bench top with a thickness of up to 35 mm. The contour of the holding fixture ensures that cuts are made at a 90° angle.

Three low-wear bending rollers made of steel allow processing of steel or stainless steel tubes with an outer diameter of 6, 8, 10 or 12 mm. The optimised bending contour of the rollers prevents deformation of the tube even for smaller bending radii. A bending lever is also included in the set.

A standard hacksaw is used for sawing off the tube.

The case also has space for the STAUFF universal internal and external tube reamer for tube diameters from 6 to 35 mm. The reamer is not included in the set, but can be purchased separately, as can all components of this convenient repair set in a robust steel case.

Ordering Code

▪ Tube Bending and Saw Device in Steelcase

TUBSD-MA-M612-LV-KIT

Spare Parts / Accessories

Description	Ordering Codes
Bending roll 6/8mm (Radius 19/20mm)	TUBSD-T-BE-M6/8-W101
Bending roll 10mm (Radius 25mm)	TUBSD-T-BE-M10-W101
Bending roll 12mm (Radius 26mm)	TUBSD-T-BE-M12-W101
Bending-Lever-compl	TUBSD-S-Bending-Lever-compl-W101
Baseplate-compl	TUBSD-S-Baseplate-compl-W101
Hold-Roll	TUBSD-S-Hold-Roll-W101
Bending-Roll-Mount	TUBSD-S-Bending-Roll-Mount-W101
Round-Head-Rivet Kit 4 pcs.	Kit-TUBSD-S-Round-Head-Rivet-W5
SAW-Guide Kit 2 pcs.	Kit-TUBSD-S-SAW-Guide-W101
Pivot-Pin	TUBSD-S-Pivot-Pin-W101
Guide-Roller-Mount	TUBSD-S-Guide-Roller-Mount-W101
Guide-Roller	TUBSD-S-Guide-Roller-W101
Butterfly lock bolt	TUBSD-S-Butterfly lock bolt W101

Parts assignment: www.stauff.com/en/category/025000/025022/025026/025022D

Product Features

- Bending and sawing with one device
- Wear-resistant steel bending rollers
- Small bending radii for compact installations
- Optimised bending contour: The tube diameter is not deformed during the bending process
- Saw blade guiding ensures 90° cuts
- Can be used with or without a vice
- Ideal for flexible mobile use, e.g. for installation work at a construction site

Technical Data

- Dimensions (W x D x H):
355 mm x 125 mm x 56 mm
- Weight (incl. Case): 3,4kg



Tube Saw Devise Type TUSD-MA

Product Description

This device can be used to cut steel and stainless steel tubes with an outer diameter between 6 and 42 mm at a precise 90° angle. It can either be used with a vice or simply clamped onto the tube for cutting.

A standard hacksaw is used for sawing off the tube.

Product Features

- 90° cut on tubes up to 42 mm
- Tube diameter is not deformed during the clamping process
- Robust, durable design
- No vice required, device can also simply be clamped onto the tube
- The saw blade guide can easily be replaced separately when it is worn
- Ideal for flexible mobile use, e.g. for installation work at a construction site

Technical Data

- Dimensions (W x D x H):
80 mm x 70 mm x 140 mm
- Weight: 1,6 kg



Ordering Code

- Tube Saw Devise

TUSD-MA-M642

Spare Parts / Accessories

Description	Ordering Codes
Round-Head-Rivet Kit 4 pcs.	Kit-SD-MA-S-Round-Head-Rivet-W5
SAW-Guide Kit 2 pcs.	Kit-SD-MA-S-Saw-Guide-W101
Barcked Bolt Kit 2 pcs.	Kit-SD-MA-S-Bolt-W32
Bracked-compl.	SD-MA-S-Bracked-compl.-W32

Parts assignment: www.stauff.com/en/category/025000/025022/025027/025022E

R

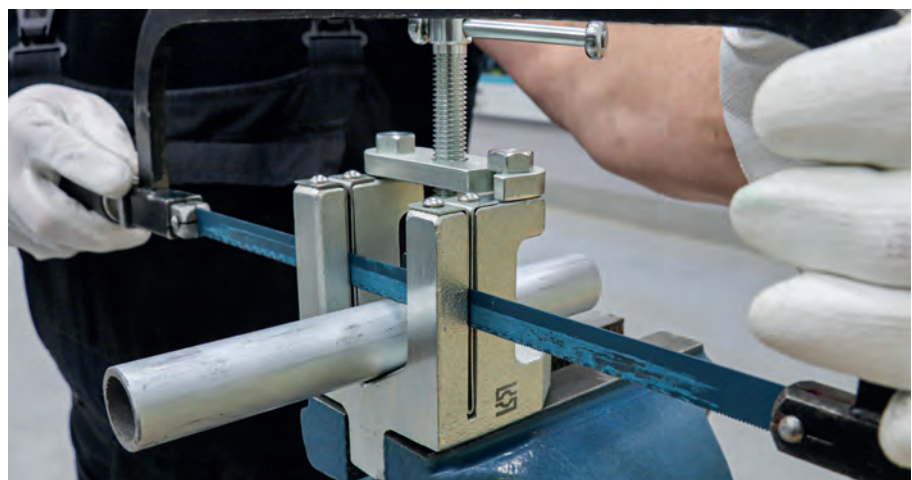

Tube Reamer Type TUD-MA

Product Description

The STAUFF universal internal and external tube reamer for tube diameters from 6 to 35 mm features high-quality sharpened cutting edges made of hardened special steel and ensures a flowing, "chatter-free" work process. Also available for tubes with an outer diameter from 10 to 54 mm.

Particularly convenient: An adapter for using the device with an electric drill at low speed is available for both sizes.

Product Features

- Easy and quick burr removal on steel and stainless steel tubes
- High-quality sharpened cutting edges made of hardened special steel
- Chatter-free working

Technical Data

- Dimensions TUD-MA-0635 (Ø x H): 48 mm x 60 mm
- Weight: 0,2 kg

- Dimensions TUD-MA-1054 (Ø x H): 70 mm x 90 mm
- Weight: 0,6 kg

- Dimensions TUD-ADA1-0635 (Ø x H): 65 mm x 85 mm inkl. Welle
- Weight: 0,2 kg

- Dimensions TUD-ADA2-1054 (Ø x H): 91 mm x 92 mm inkl. Welle
- Weight: 0,4 kg



Ordering Codes

Description	Ordering Codes
Tube reamer 6-35mm	TUD-MA-0635
Adapter for Tube reamer 6-35mm	TUD-ADA1-0635
Tube reamer 10-54mm	TUD-MA-1054
Adapter for Tube reamer 10-54mm	TUD-ADA2-1054



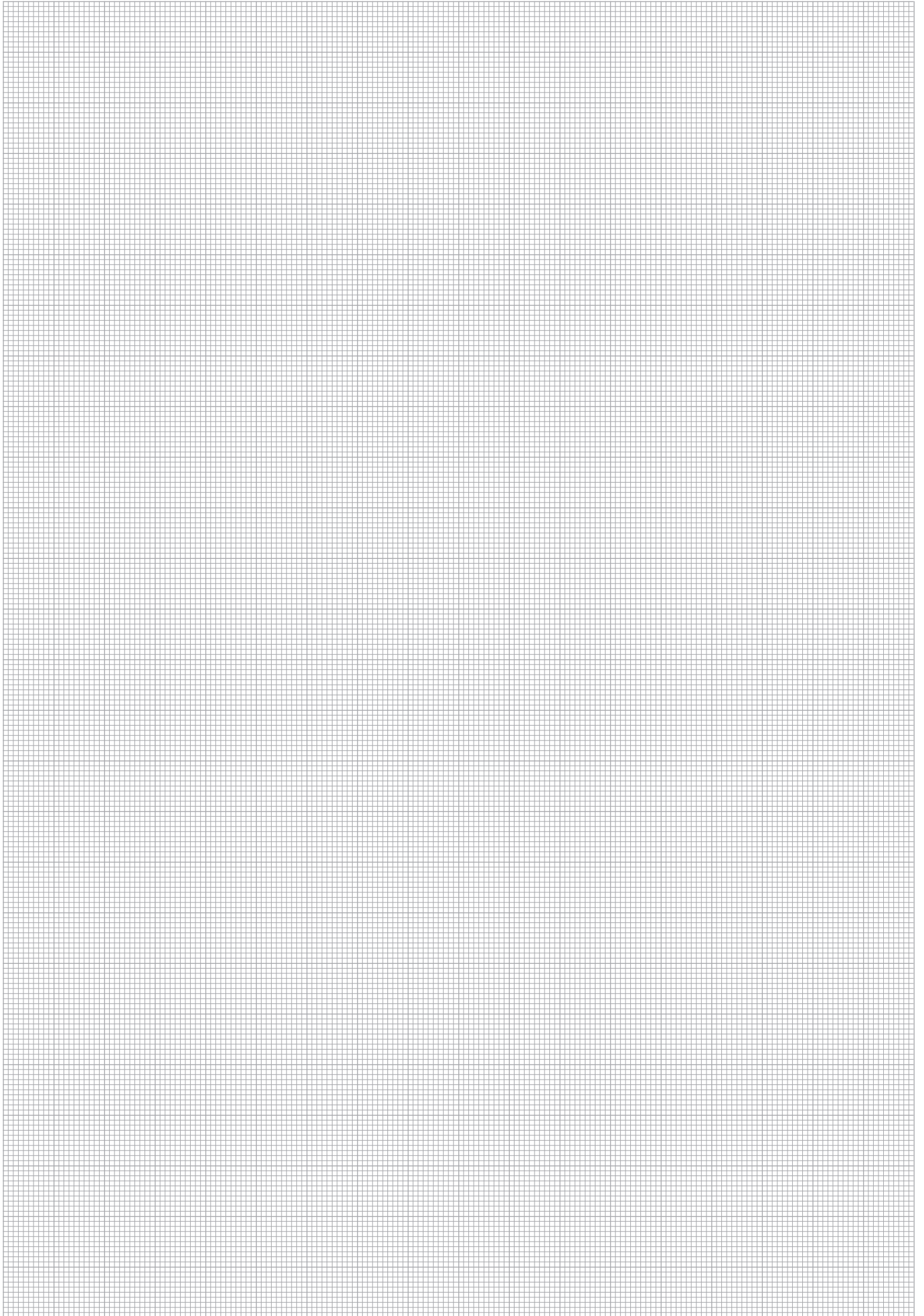

R



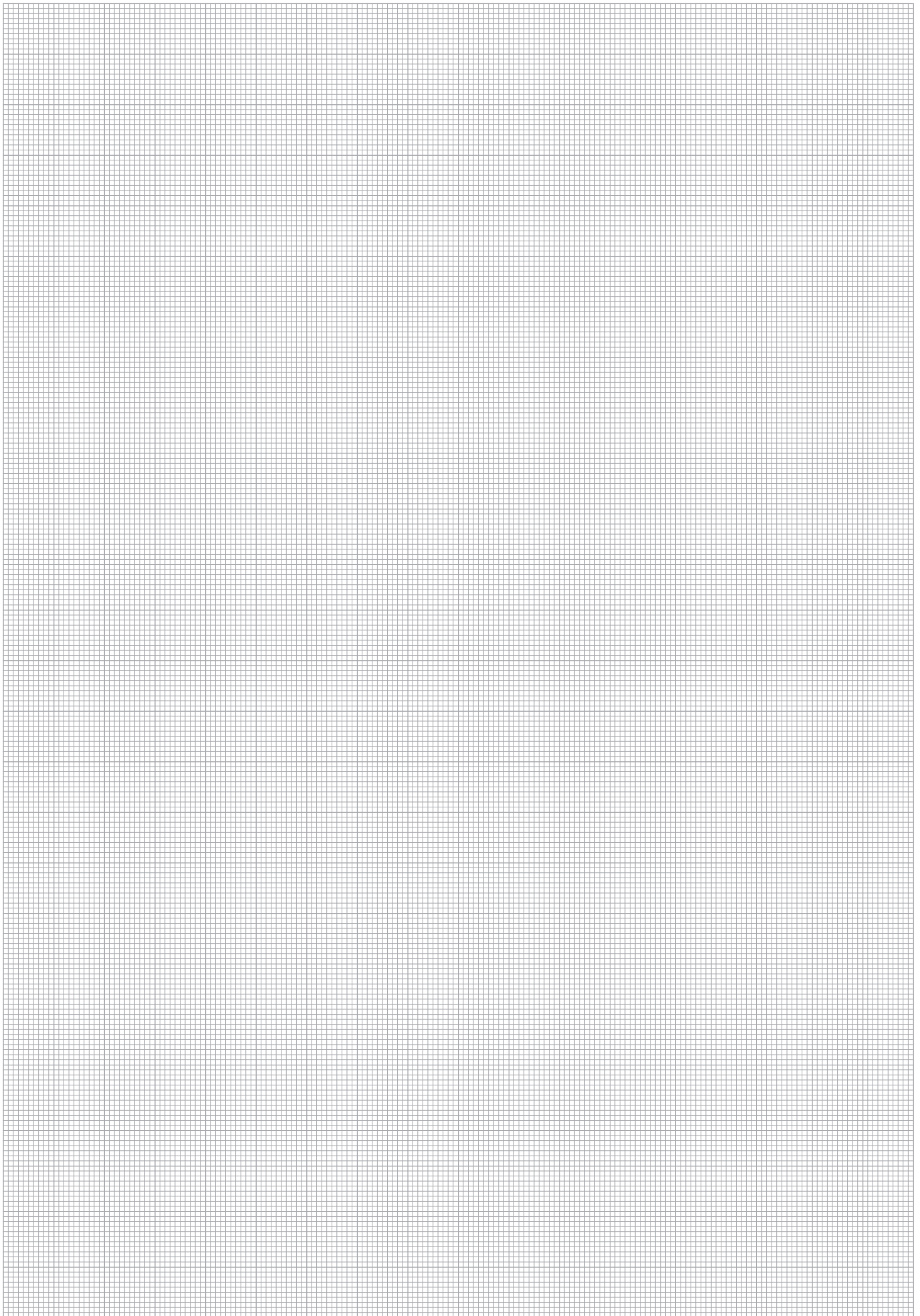

R





Assembly Instructions for STAUFF Connect 24° Tube Fittings with Double Edge Cutting Ring (Type FI-DS)	294-303
100% Assembly with the Manual Final Assembly Stud (Type FI-FK) and Assembly with the Fitting Body	296
Pre-Assembly with the Manual Pre-Assembly Stud (Type FI-FK) and Assembly with the Fitting Body	298
Direct Assembly with the Fitting Body	300
Machine-Assisted 100% Assembly with a STAUFF Press Assembly Machine and Assembly with the Fitting Body	302
Machine-Assisted Pre-Assembly with a STAUFF Press Assembly Machine and Assembly with the Fitting Body	303
Assembly Instructions for STAUFF Connect 24° Tube Fittings with Soft-Sealing Cutting Ring (Type FI-WDDS)	304-309
Pre-Assembly with the Manual Final Assembly Stud (Type FI-FK) and Assembly with the Fitting Body	304
Direct Assembly with the Fitting Body	306
Machine-Assisted Pre-Assembly with a STAUFF Press Assembly Machine and Assembly with the Fitting Body	308
Assembly Instructions for Support Sleeves	310
Assembly Instructions for STAUFF Form EVO Tube Fittings	312
Assembly Instructions for STAUFF Connect 37° Flared Tube Fittings	316
Assembly Instructions for 24° Weld Cones with O-Ring	320
Assembly Instructions for Tube Fittings with 24° Taper and O-Ring	322
Assembly Instructions for Tube Fittings with Standpipe	322
Assembly Instructions for Tube Fittings with Male Threaded Stud	323
Assembly Instructions for Banjo Fittings	326
Assembly Instructions for Adjustable Fitting with Locknut (WEE, VEE, TEE, LEE)	327



Assembly Instructions for STAUFF Connect 24° Tube Fittings with Double Edge Cutting Ring (Type FI-DS)

100% Assembly with the Manual Final Assembly Stud (Type FI-FK) and Assembly with the Fitting Body

1. Tube Preparation

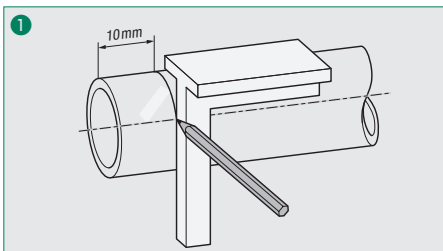

1 Saw off tube in right angle and at least 10 mm from the cut made by the tube manufacturer / supplier in order to avoid failures caused during shipment.

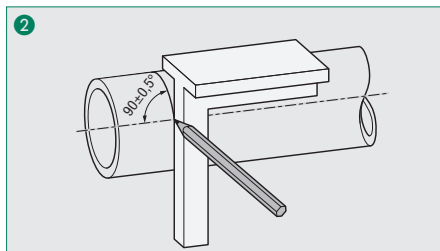

2 A maximum angular deviation / tolerance of $\pm 0,5^\circ$ relative to the tube axis is permissible.

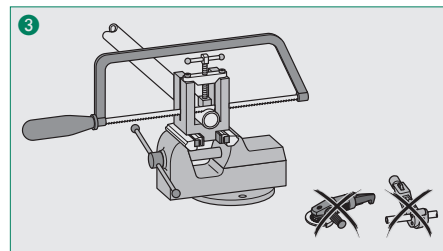

3 Only use proper tube sawing machinery or equipment. Do not use tube cutters or grinders as this may result in unwanted angled cuts and cause severe burring.

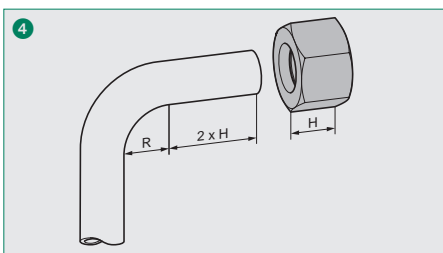

4 For tube bends, the length of the straight section of the tube end to the start of the bending radius has to be twice the height of the union nut.

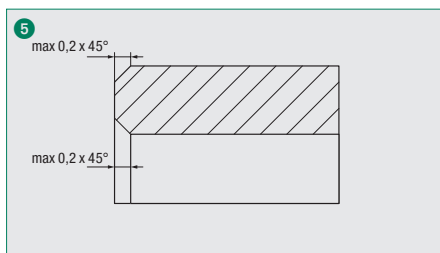

5 Slightly deburr inside and outside of the tube end (max $0,2 \times 45^\circ$). The assembly area of the tube has to be free of contamination, chips and paint.



6 Please note: Improperly prepared and contaminated tubes will affect the service life of the connection and may result in leakage.

2. Assembly Preparation

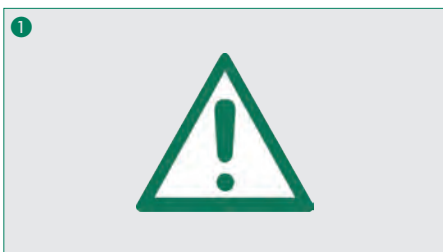

1 Please note: Hardened final assembly studs are wear-resistant, thus allowing for consistent assembly results with a maximum degree of accuracy, reliability and process stability.

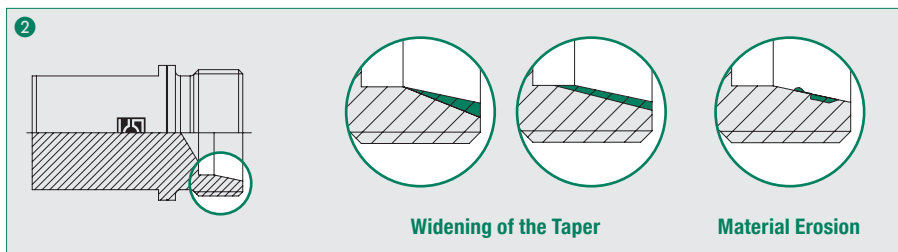

2 However, they have to be checked for dimensional accuracy regularly. Assembly studs that are damaged and/or dimensionally not accurate must be replaced under any circumstances!

Typical damages include widening of the 24° angle or the entire taper, as well as material erosion.

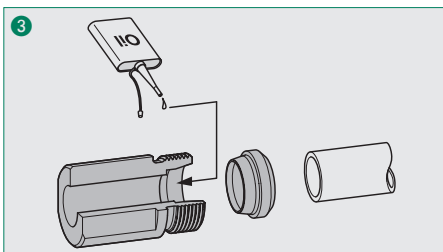

3 Lightly lubricate the 24° taper of the final assembly stud (e.g. using mineral-oil based hydraulic fluid HLP32). Do not use lubricating grease!

Immediately proceed with the assembly in order to avoid exposure to contamination.

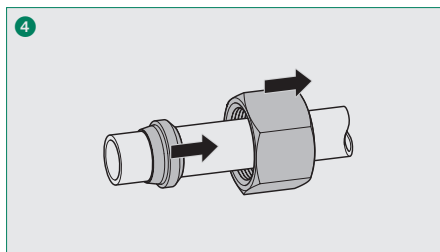

4 Consecutively put the union nut first and then the cutting ring onto the tube end.

Pay attention to the correct alignment of the cutting ring: The cutting edges have to face to the tube end.

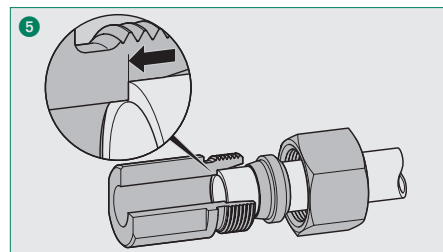

5 Carefully insert the tube end into the 24° taper of the final assembly stud and push it firmly against the inner stop.

The tube must be held in this position during the entire assembly process in order to avoid faulty assembly.

S



Assembly Instructions for STAUFF Connect 24° Tube Fittings with Double Edge Cutting Ring (Type FI-DS)

100% Assembly with the Manual Final Assembly Stud (Type FI-FK) and Assembly with the Fitting Body

3. Assembly in the Assembly Stud

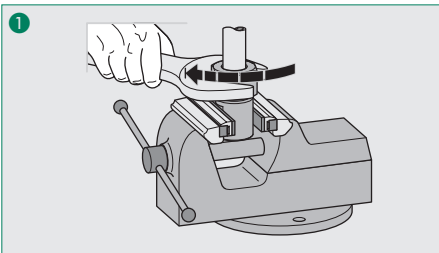

Tighten the union nut until the noticeable increase in force (pressure point). The cutting ring now grips the tube, which can no longer be rotated.

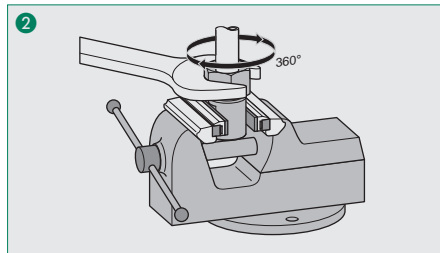

Use a suitable spanner to tighten the union nut another full turn (360°) beyond the pressure point. In doing so, the cutting ring will uniformly cut into the tube.

4. Inspection

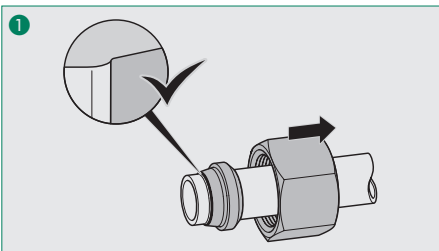

Fully untighten the union nut for a visual inspection after the assembly. The material accumulation must be clearly visible in front of the cutting edge and should almost completely cover the cutting edge.

In this position, it is still permissible for the cutting ring to turn on the tube, but not to be displaced in axial direction of the tube.



Please note: If not enough tube material has been raised in front of the cutting edge or if the cutting ring is still capable of being displaced in axial direction, the assembly procedure must be repeated by using more force, and the result must be re-checked.

5. Final-Assembly with the Fitting Body

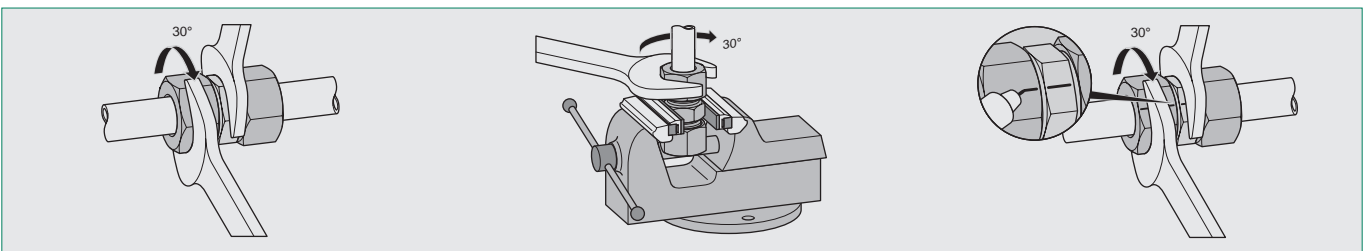

Carefully insert the assembled tube end into the 24° taper of the fitting body.

Use a suitable spanner to tighten the union nut until the noticeable increase in force, and then finish the assembly with another approximately 1/12 a turn (30°) beyond this point.

Always use a second spanner to hold the fitting body during the entire assembly procedure.

In case of unfavourable mounting conditions or larger tube dimensions, use a bench vice for the assembly.

A marking line applied on the union nut and the fitting body makes it easier to indicate the sufficient tightening angle.

6. Repeated Assembly

For repeated assemblies, please use a suitable spanner to tighten the union nut until the noticeable increase in force, and then finish the assembly with another approximately 1/12 a turn (30°) beyond this point.

Assembly Instructions for STAUFF Connect 24° Tube Fittings with Double Edge Cutting Ring (Type FI-DS) Assembly with the Manual Pre-Assembly Stud (Type FI-FK) and Assembly with the Fitting Body

1. Tube Preparation

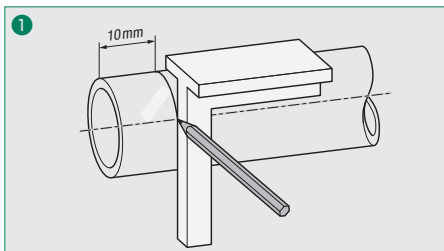

1 Saw off tube in right angle and at least 10 mm from the cut made by the tube manufacturer / supplier in order to avoid failures caused during shipment.

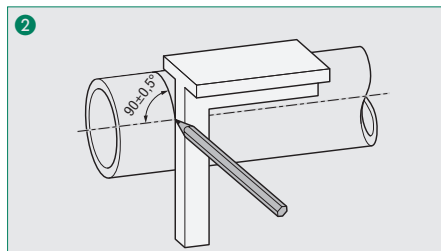

2 A maximum angular deviation / tolerance of $\pm 0,5^\circ$ relative to the tube axis is permissible.

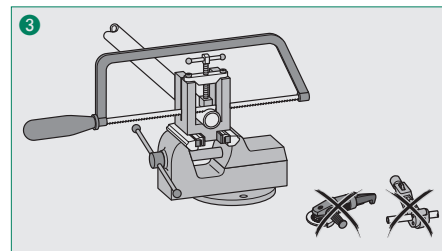

3 Only use proper tube sawing machinery or equipment. Do not use tube cutters or grinders as this may result in unwanted angled cuts and cause severe burring.

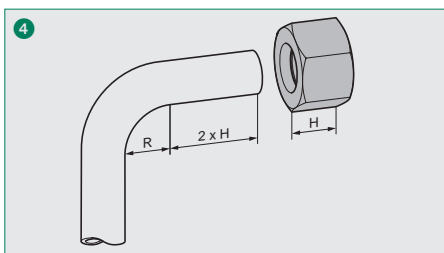

4 For tube bends, the length of the straight section of the tube end to the start of the bending radius has to be twice the height of the union nut.

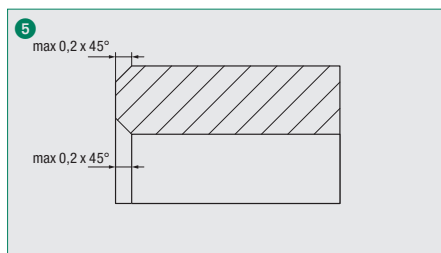

5 Slightly deburr inside and outside of the tube end (max 0,2 x 45°). The assembly area of the tube has to be free of contamination, chips and paint.



6 Please note: Improperly prepared and contaminated tubes will affect the service life of the connection and may result in leakage.

2. Assembly Preparation

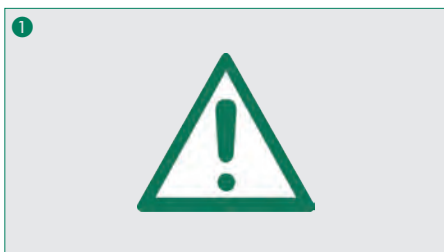

1 Please note: Hardened pre-assembly studs are wear-resistant, thus allowing for consistent assembly results with a maximum degree of accuracy, reliability and process stability.

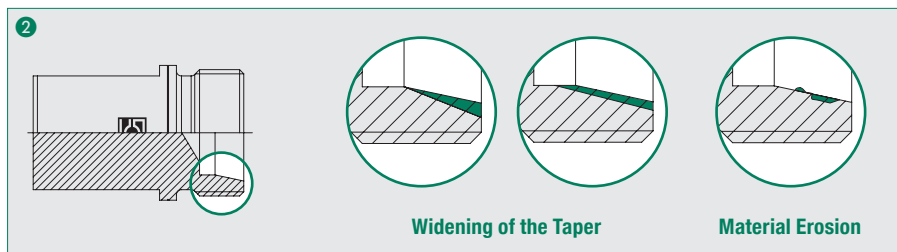

2 However, they have to be checked for dimensional accuracy regularly. Assembly studs that are damaged and/or dimensionally not accurate must be replaced under any circumstances!

Typical damages include widening of the 24° angle or the entire taper, as well as material erosion.

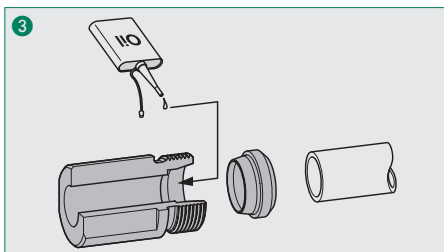

3 Lightly lubricate the 24° taper of the pre-assembly stud (e.g. using mineral-oil based hydraulic fluid HLP32). Do not use lubricating grease!

Immediately proceed with the assembly in order to avoid exposure to contamination.

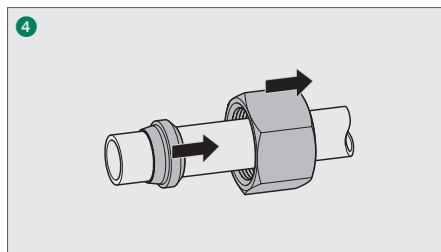

4 Consecutively put the union nut first and then the cutting ring onto the tube end.

Pay attention to the correct alignment of the cutting ring: The cutting edges have to face to the tube end.

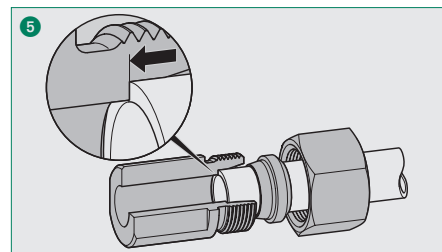

5 Carefully insert the tube end into the 24° taper of the pre-assembly stud and push it firmly against the inner stop.

The tube must be held in this position during the entire assembly process in order to avoid faulty assembly.

S



Assembly Instructions for STAUFF Connect 24° Tube Fittings with Double Edge Cutting Ring (Type FI-DS) Assembly with the Manual Pre-Assembly Stud (Type FI-FK) and Assembly with the Fitting Body

3. Pre-Assembly in the Assembly Stud

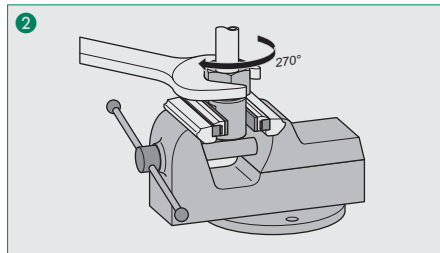
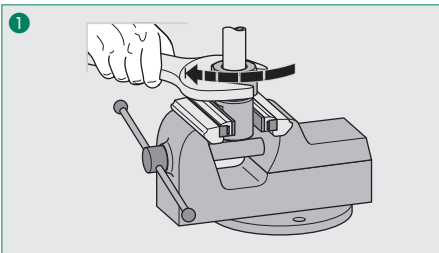

Tighten the union nut until the noticeable increase in force (pressure point). The cutting ring now grips the tube, which can no longer be rotated.

Use a suitable spanner to tighten the union nut another 3/4 a turn (270°) beyond the pressure point. In doing so, the cutting ring will uniformly cut into the tube.

4. Final-Assembly with the Fitting Body

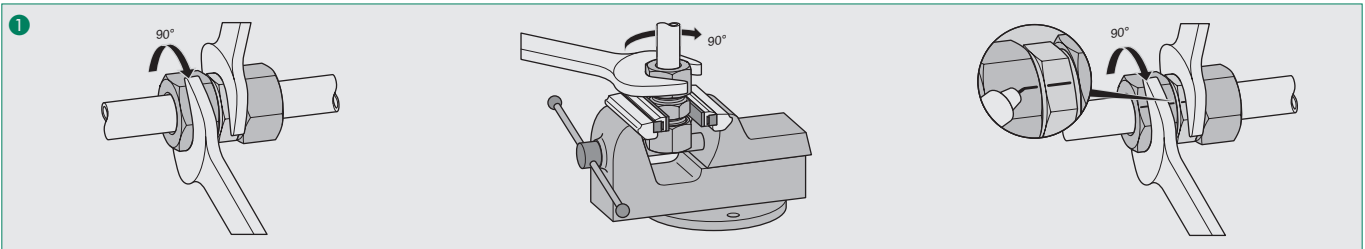

Carefully insert the assembled tube end into the 24° taper of the fitting body.

Use a suitable spanner to tighten the union nut until the noticeable increase in force, and then finish the assembly with another approximately 1/4 a turn (90°) beyond this point.

Always use a second spanner to hold the fitting body during the entire assembly procedure.

In case of unfavourable mounting conditions or larger tube dimensions, use a bench vice for the assembly.

A marking line applied on the union nut and the fitting body makes it easier to indicate the sufficient tightening angle.

5. Inspection

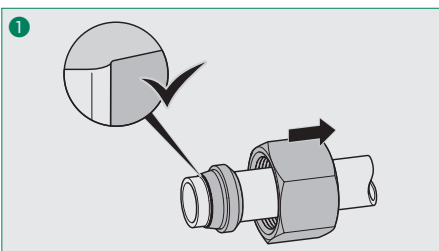

Fully untighten the union nut for a visual inspection after the assembly. The material accumulation must be clearly visible in front of the cutting edge and should cover the cutting edge approx. 80%.

In this position, it is still permissible for the cutting ring to turn on the tube, but not to be displaced in axial direction of the tube.

Please note: If not enough tube material has been raised in front of the cutting edge or if the cutting ring is still capable of being displaced in axial direction, the assembly procedure must be repeated by using more force, and the result must be re-checked.

6. Repeated Assembly

For repeated assemblies, please use a suitable spanner to tighten the union nut until the noticeable increase in force, and then finish the assembly with another approximately 1/12 a turn (30°) beyond this point.

S

Assembly Instructions for STAUFF Connect 24° Tube Fittings with Double Edge Cutting Ring (Type FI-DS) Direct Assembly with the Fitting Body

1. Tube Preparation

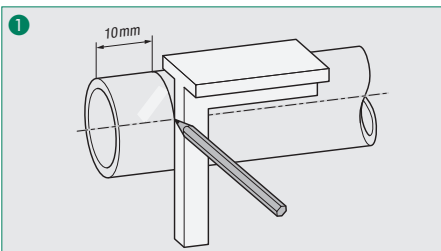

1 Saw off tube in right angle and at least 10 mm from the cut made by the tube manufacturer / supplier in order to avoid failures caused during shipment.

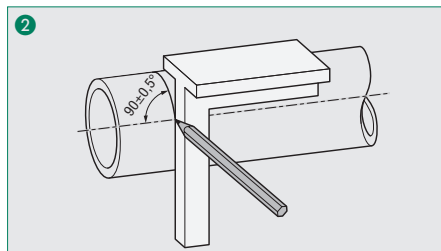

2 A maximum angular deviation / tolerance of $\pm 0,5^\circ$ relative to the tube axis is permissible.

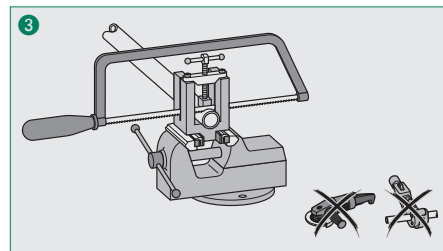

3 Only use proper tube sawing machinery or equipment. Do not use tube cutters or grinders as this may result in unwanted angled cuts and cause severe burring.

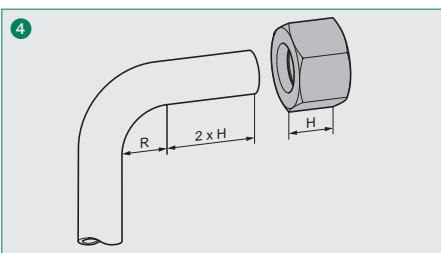

4 For tube bends, the length of the straight section of the tube end to the start of the bending radius has to be twice the height of the union nut.

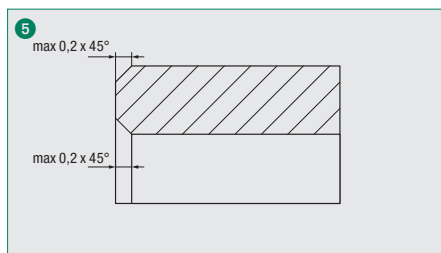

5 Slightly deburr inside and outside of the tube end (max $0,2 \times 45^\circ$). The assembly area of the tube has to be free of contamination, chips and paint.



6 Please note: Improperly prepared and contaminated tubes will affect the service life of the connection and may result in leakage.

2. Assembly Preparation

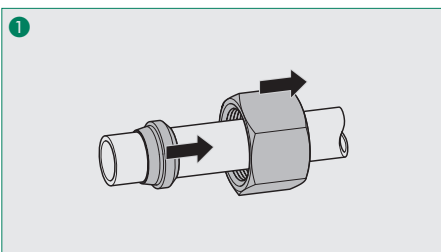

1 Consecutively put the union nut first and then the cutting ring onto the tube end.

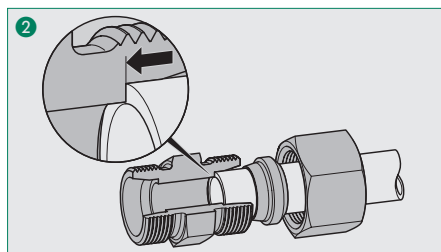

2 Carefully insert the tube end into the 24° taper of the fitting body and push it firmly against the inner stop.

Pay attention to the correct alignment of the cutting ring: The cutting edges have to face to the tube end.

The tube must be held in this position during the entire assembly process in order to avoid faulty assembly.

S



Assembly Instructions for STAUFF Connect 24° Tube Fittings with Double Edge Cutting Ring (Type FI-DS) Direct Assembly with the Fitting Body

3. Direct Assembly in the Fitting Body

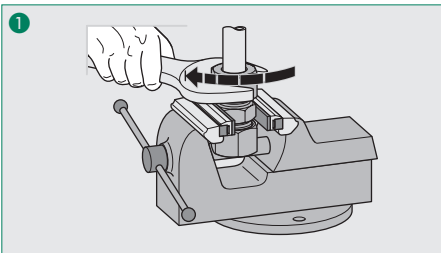

Tighten the union nut until the noticeable increase in force (pressure point). The cutting ring now grips the tube, which can no longer be rotated.

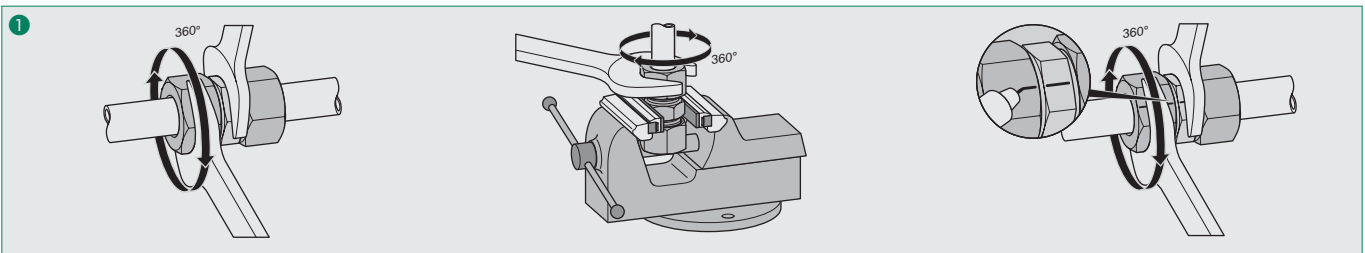

Use a suitable spanner to tighten the union nut another full turn (360°) beyond the pressure point. In doing so, the cutting ring will uniformly cut into the tube.

Always use a second spanner to hold the fitting body during the entire assembly procedure.

In case of unfavourable mounting conditions or larger tube dimensions, use a bench vice for the assembly.

A marking line applied on the union nut and the fitting body makes it easier to indicate the sufficient tightening angle.

4. Inspection

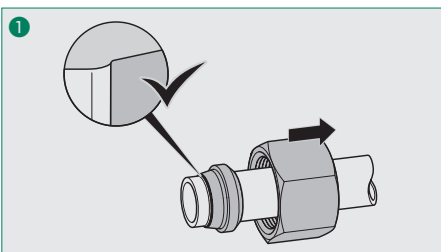

Fully untighten the union nut for a visual inspection after the assembly. The material accumulation must be clearly visible in front of the cutting edge and should almost completely cover the cutting edge.

In this position, it is still permissible for the cutting ring to turn on the tube, but not to be displaced in axial direction of the tube.



Please note: If not enough tube material has been raised in front of the cutting edge or if the cutting ring is still capable of being displaced in axial direction, the assembly procedure must be repeated by using more force, and the result must be re-checked.

5. Repeated Assembly

For repeated assemblies, please use a suitable spanner to tighten the union nut until the noticeable increase in force, and then finish the assembly with another approximately 1/12 a turn (30°) beyond this point.

Assembly Instructions for STAUFF Connect 24° Tube Fittings with Double Edge Cutting Ring (Type FI-DS) Machine-Assisted 100% Assembly with a STAUFF Press Assembly Machine and Assembly with the Fitting Body

1. Tube Preparation

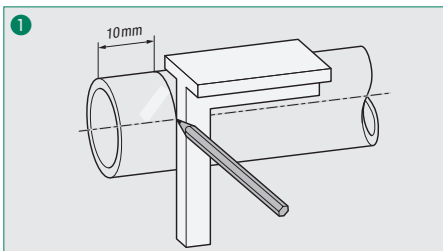

1 Saw off tube in right angle and at least 10 mm from the cut made by the tube manufacturer / supplier in order to avoid failures caused during shipment.

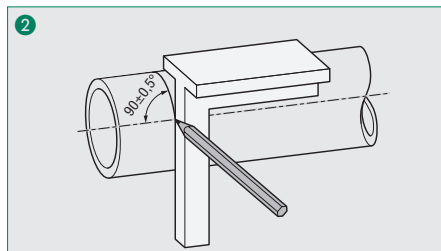

2 A maximum angular deviation / tolerance of $\pm 0,5^\circ$ relative to the tube axis is permissible.

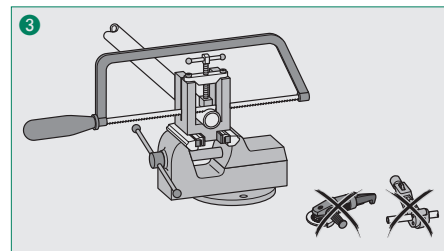

3 Only use proper tube sawing machinery or equipment. Do not use tube cutters or grinders as this may result in unwanted angled cuts and cause severe burring.

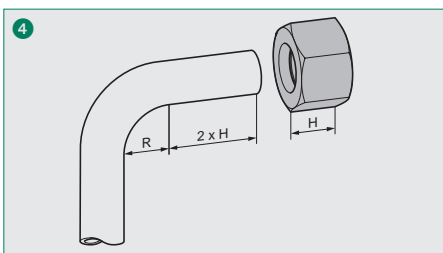

4 For tube bends, the length of the straight section of the tube end to the start of the bending radius has to be twice the height of the union nut.

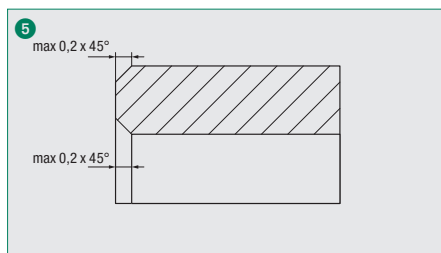

5 Slightly deburr inside and outside of the tube end (max $0,2 \times 45^\circ$). The assembly area of the tube has to be free of contamination, chips and paint.



6 Please note: Improperly prepared and contaminated tubes will affect the service life of the connection and may result in leakage.

2. Assembly Preparation, Machine-Assisted Assembly and Inspection

With regards to assembly preparation, the actual assembly as well as the inspection of assembled tube ends, please follow the detailed instructions in the operating manual of the machine.



3. Final-Assembly with the Fitting Body

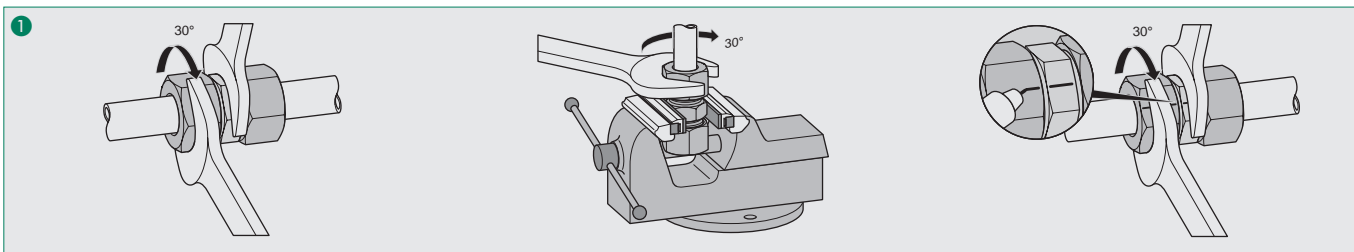

1 Carefully insert the assembled tube end into the 24° taper of the fitting body.

Use a suitable spanner to tighten the union nut until the noticeable increase in force, and then finish the assembly with another approximately 1/12 a turn (30°) beyond this point.

Always use a second spanner to hold the fitting body during the entire assembly procedure.

In case of unfavourable mounting conditions or larger tube dimensions, use a bench vice for the assembly.

A marking line applied on the union nut and the fitting body makes it easier to indicate the sufficient tightening angle.

4. Repeated Assembly

For repeated assemblies, please use a suitable spanner to tighten the union nut until the noticeable increase in force, and then finish the assembly with another approximately 1/12 a turn (30°) beyond this point.



Assembly Instructions for STAUFF Connect 24° Tube Fittings with Double Edge Cutting Ring (Type FI-DS)

Machine-Assisted Pre-Assembly with a STAUFF Press Assembly Machine and Assembly with the Fitting Body

1. Tube Preparation

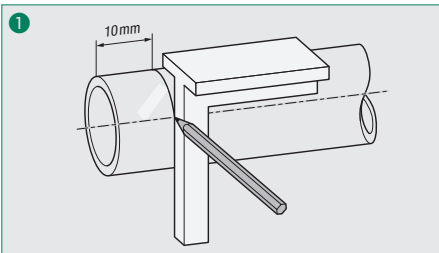

Saw off tube in right angle and at least 10 mm from the cut made by the tube manufacturer / supplier in order to avoid failures caused during shipment.

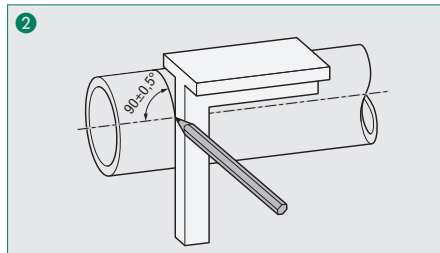

A maximum angular deviation / tolerance of $\pm 0,5^\circ$ relative to the tube axis is permissible.

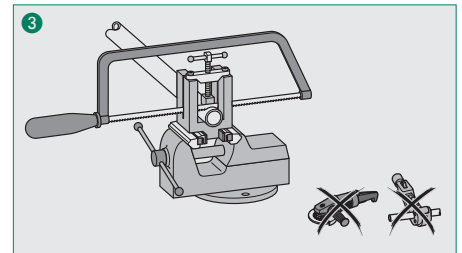

Only use proper tube sawing machinery or equipment. Do not use tube cutters or grinders as this may result in unwanted angled cuts and cause severe burring.

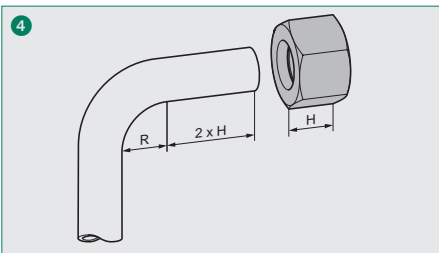

For tube bends, the length of the straight section of the tube end to the start of the bending radius has to be twice the height of the union nut.

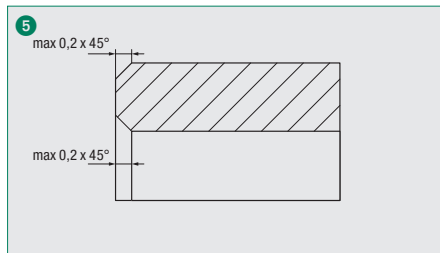

Slightly deburr inside and outside of the tube end (max $0,2 \times 45^\circ$). The assembly area of the tube has to be free of contamination, chips and paint.

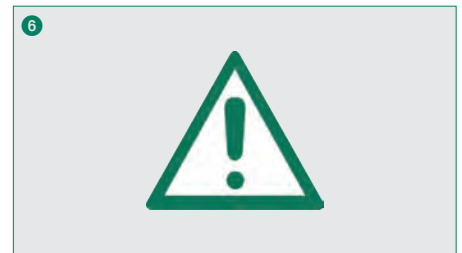

Please note: Improperly prepared and contaminated tubes will affect the service life of the connection and may result in leakage.

2. Assembly Preparation, Machine-Assisted Assembly and Inspection

With regards to assembly preparation, the actual assembly as well as the inspection of assembled tube ends, please follow the detailed instructions in the operating manual of the machine.



3. Final-Assembly with the Fitting Body

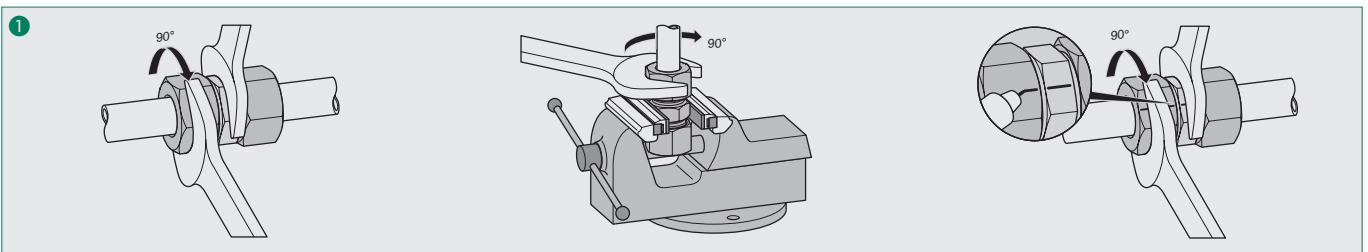

Carefully insert the assembled tube end into the 24° taper of the fitting body.

Use a suitable spanner to tighten the union nut until the noticeable increase in force, and then finish the assembly with another approximately 1/4 a turn (90°) beyond this point.

Always use a second spanner to hold the fitting body during the entire assembly procedure.

In case of unfavourable mounting conditions or larger tube dimensions, use a bench vice for the assembly.

A marking line applied on the union nut and the fitting body makes it easier to indicate the sufficient tightening angle.

4. Repeated Assembly

For repeated assemblies, please use a suitable spanner to tighten the union nut until the noticeable increase in force, and then finish the assembly with another approximately 1/12 a turn (30°) beyond this point.



Assembly Instructions for 24° Tube Connectors with Soft-Sealing Cutting Ring (Type FI-WDDS/FI-WDDS-W5) Pre-Assembly with the Manual Final Assembly Stud Type FI-FK and Assembly in the Fitting Body

1. Tube Preparation

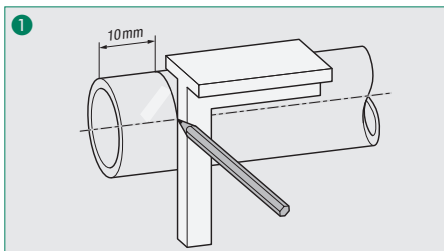

Saw off tube at a right angle (90°) and at least 10 mm from the cut made by the manufacture / supplier.

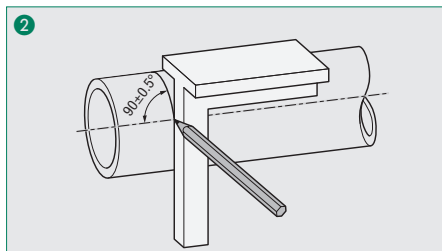

A maximum angular deviation of $\pm 0.5^\circ$ to the tube axis is permissible.

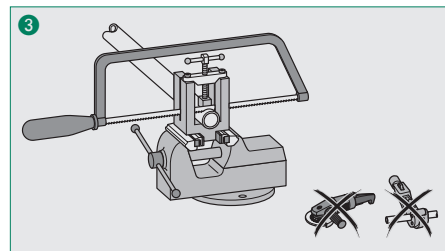

Do not use tube cutters or grinders.

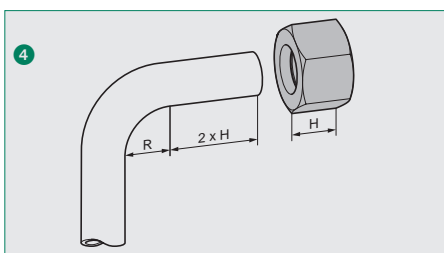

The length of the straight sections of the tube of tube bends has to be twice the length of the union nut.

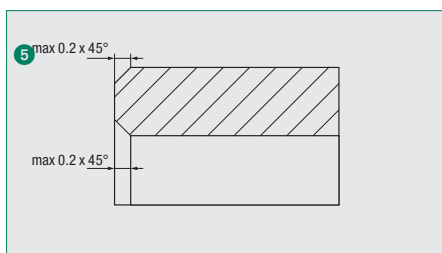

Slightly deburr the inside and outside of the tube end (max 0.2 x 45°). The assembly area of the tube has to be free of dirt, chips and paint.



Please note: Improperly prepared and contaminated tubes will affect the service life of the tube connectors and may result in leakage. Poorly deburred tube ends can result in damage to the internal O-ring!



Please note: Assembly of reinforcing sleeves is essential when using thin-walled tubes. Refer to page 310.

2. Assembly Preparation

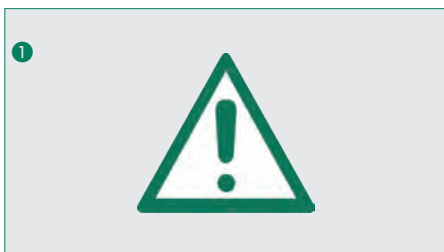

Hardened assembly studs are wear-resistant, thus allowing for consistent assembly results with a maximum degree of accuracy, reliability and process stability.

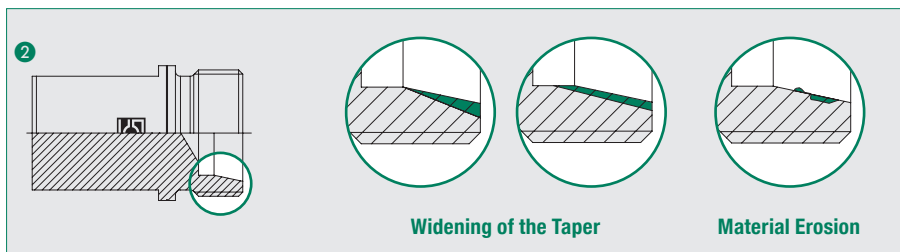

Assembly studs must be checked regularly for damage and dimensional accuracy. Replace assembly studs that are damaged and/or dimensionally inaccurate in all cases.

Typical damage includes the partial or complete widening of the 24° taper, as well as material erosion.

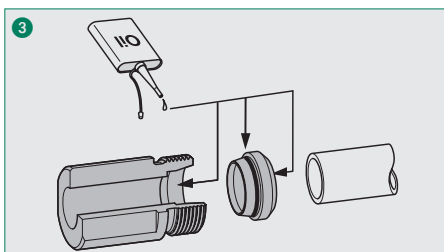

Lubricate the 24° taper of the assembly stud as well as the two soft-sealing elements of the cutting ring (e.g. using hydraulic oil HLP32). Do not use lubricating grease!

Immediately proceed with assembly to avoid the adhesion of dirt.

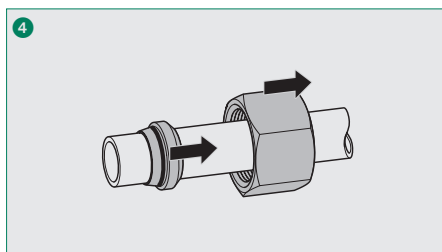

Consecutively push the union nut and then the cutting ring onto the tube end.

Pay attention to the correct alignment of the cutting ring: the cutting edges of the cutting ring have to face the tube end.

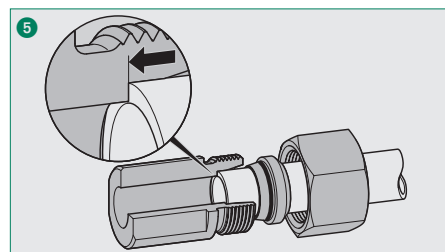

Carefully insert the tube end into the 24° taper of the assembly stud until it is flush with the stop.

The tube must be held in this position during the entire assembly process.



Assembly Instructions for 24° Tube Connectors with Soft-Sealing Cutting Ring (Type FI-WDDS/FI-WDDS-W5) Pre-Assembly with the Manual Final Assembly Stud Type FI-FK and Assembly in the Fitting Body

3. Pre-Assembly in the Assembly Stud

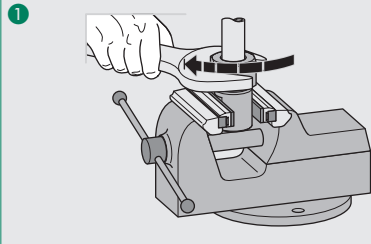

! Please note when use FI-WDDS-W5 with Stainless Steel Fitting Body: Thread and 45° cone of the union nut and thread of the fitting body grease with special stainless steel fitting grease or use a silver coated union nut.

Use a suitable spanner.
Tighten the union nut to the point where there is a first increase in force, the pressure point.
The pressure point defines the point at which the cutting ring starts gripping the tube.

The tube can then no longer be rotated in the fitting.
Now tighten the union nut to the end of the assembly.
The end of the assembly is situated approx. 1 turn (360°) beyond the pressure point and is signalled by a significant increase in force.

The cutting ring comes into contact with the face side of the fitting body.

4. Inspection

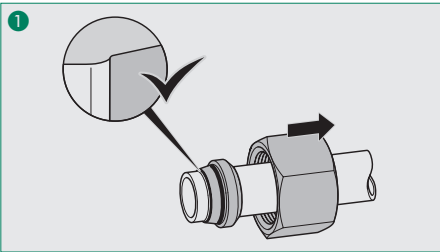

Fully loosen the union nut to visually inspect the assembly. There must be raised material clearly visible in front of the cutting edge and should cover the cutting edge approx. 80%.

Under certain circumstances, it is still possible at this time to turn the cutting ring on the tube (radial direction). It can no longer be moved in the direction of the tube (axial direction).

5. Final-Assembly with the Fitting Body

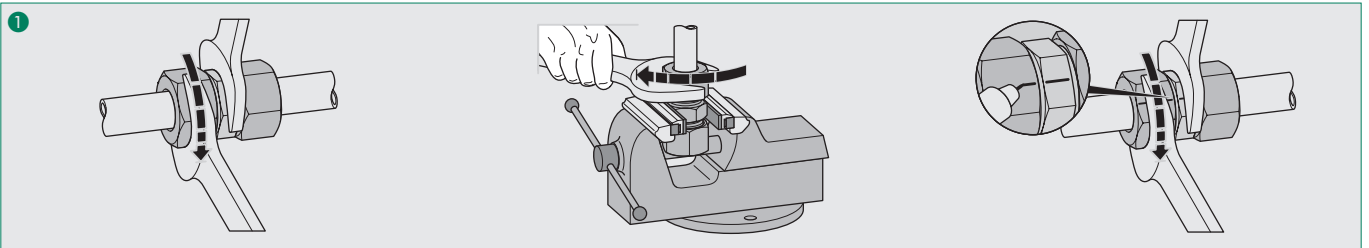

! Please note when use FI-WDDS-W5 with Stainless Steel Fitting Body: Thread and 45° cone of the union nut and thread of the fitting body grease with special stainless steel fitting grease or use a silver coated union nut.

Lightly lubricate the soft-sealing element located on the 24° taper of the cutting ring (e.g. using hydraulic oil HLP32). Do not use lubricating grease!

Immediately proceed with assembly to avoid the adhesion of dirt.

Carefully insert the assembled tube end into the 24° taper of the fitting body.

Tighten the union nut to the point where there is a first increase in force. Then tighten the union nut to the end of the assembly.

The cutting ring comes into contact with the face side of the fitting body after approx. 90°-120°. The end of the assembly is once again indicated by a significant increase in force.

Use a suitable spanner to hold the fitting body within the tube during the entire assembly process. Use a bench vice for assembly in the event of unfavourable assembly conditions or larger tube dimensions.

A marking line on the union nut and the fitting body makes it easier to note and check the correct tightening angle.

6. Repeated Assembly

Check the soft-sealing element located on the 24° taper of the cutting ring for possible damage.

Carefully insert the tube end into the 24° taper of the fitting body.

Then tighten the union nut to the end of the assembly.
The cutting ring comes into contact with the face side of the fitting body after approx. 90°-120°. The end of the assembly is once again indicated by a significant increase in force.



Assembly Instructions for 24° Tube Connectors with Soft-Sealing Cutting Ring (Type FI-WDDS/FI-WDDS-W5) Direct Assembly in the Fitting Body

1. Tube Preparation

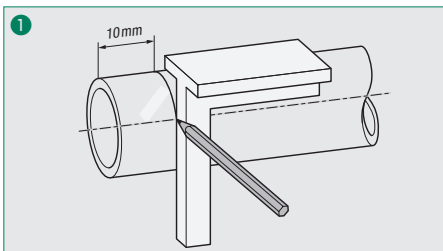

1 Saw off tube at a right angle (90°) and at least 10 mm from the cut made by the manufacture / supplier.

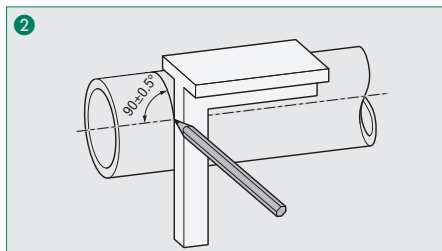

2 A maximum angular deviation of $\pm 0.5^\circ$ to the tube axis is permissible.

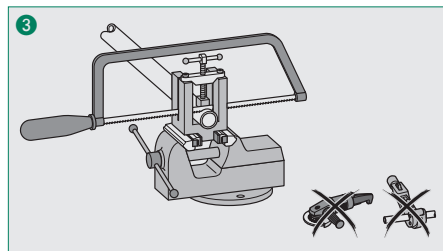

3 Do not use tube cutters or grinders.

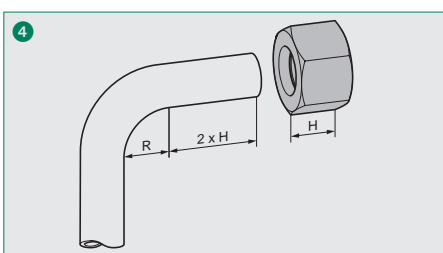

4 The length of the straight sections of the tube of tube bends has to be twice the length of the union nut.

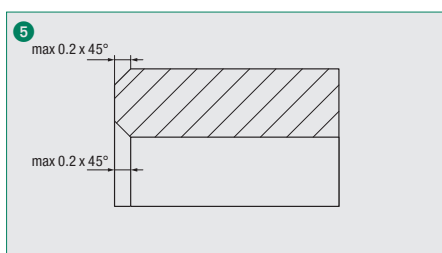

5 Slightly deburr the inside and outside of the tube end (max 0.2 x 45°). The assembly area of the tube has to be free of dirt, chips and paint.



6 Please note: Improperly prepared and contaminated tubes will affect the service life of the tube connectors and may result in leakage. Poorly deburred tube ends can result in damage to the internal O-ring!



Please note: Assembly of reinforcing sleeves is essential when using thin-walled tubes. Refer to page 310.

2. Assembly Preparation

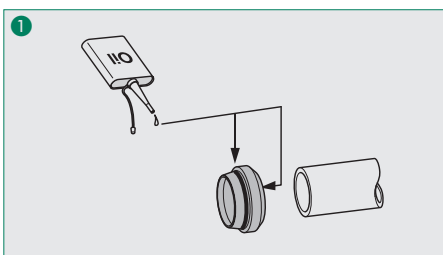

1 Lightly lubricate the two soft-sealing elements of the cutting ring (e.g. using hydraulic oil HLP32). Do not use lubricating grease!

Immediately proceed with assembly to avoid the adhesion of dirt.

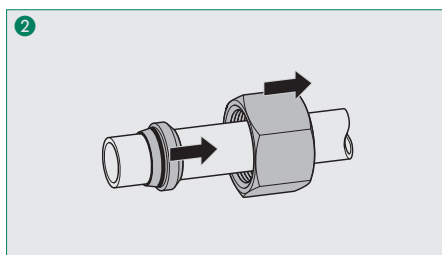

2 Consecutively push the union nut and then the cutting ring onto the tube end.

Pay attention to the correct alignment of the cutting ring: the cutting edges of the cutting ring have to face the tube end.

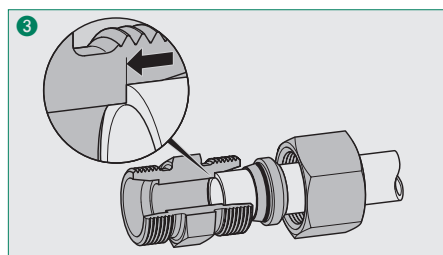

3 Carefully insert the tube end into the 24° taper of the fitting body until it is flush with the stop.

The tube must be held in this position during the entire assembly process.



Please note when use FI-WDDS-W5 with Stainless Steel Fitting Body: Thread and 45° cone of the union nut and thread of the fitting body grease with special stainless steel fitting grease or use a silver coated union nut.



Assembly Instructions for 24° Tube Connectors with Soft-Sealing Cutting Ring (Type FI-WDDS/FI-WDDS-W5) Direct Assembly in the Fitting Body

3. Pre-Assembly in the Fitting Body

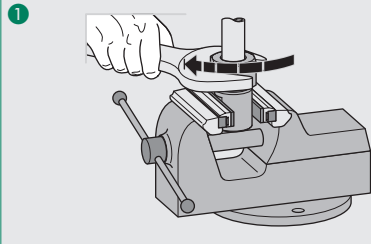

Please note when use FI-WDDS-W5 with Stainless Steel Fitting Body: Thread and 45° cone of the union nut and thread of the fitting body grease with special stainless steel fitting grease or use a silver coated union nut.

Use a suitable spanner. Tighten the union nut to the point where there is a first increase in force, the pressure point. The pressure point defines the point at which the cutting ring starts gripping the tube.

The tube can then no longer be rotated in the fitting. Now tighten the union nut to the end of the assembly. The end of the assembly is situated approx. 1 turn (360°) beyond the pressure point and is signalled by

a significant increase in force. The cutting ring comes into contact with the face side of the fitting body.

4. Inspection

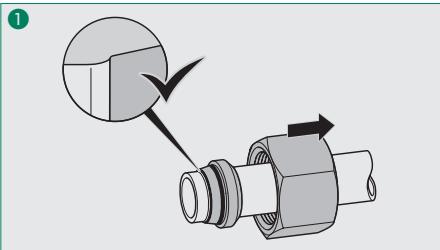

Fully loosen the union nut to visually inspect the assembly. There must be raised material clearly visible in front of the cutting edge and should cover the cutting edge approx. 80%.

Under certain circumstances, it is still possible at this time to turn the cutting ring on the tube (radial direction). It can no longer be moved in the direction of the tube (axial direction).

5. Final-Assembly with the Fitting Body

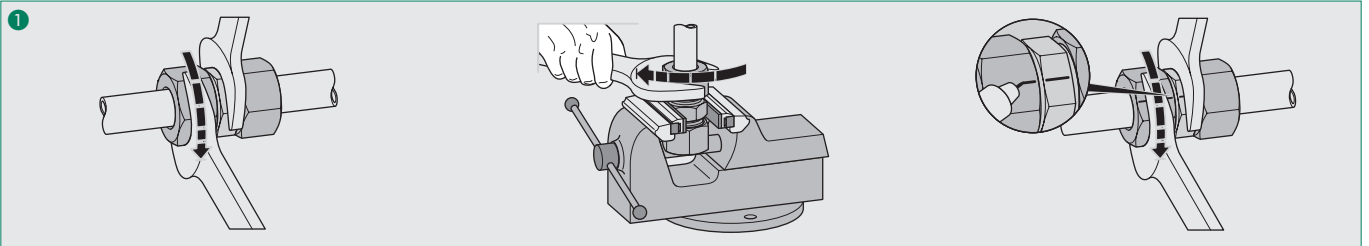

Please note when use FI-WDDS-W5 with Stainless Steel Fitting Body: Thread and 45° cone of the union nut and thread of the fitting body grease with special stainless steel fitting grease or use a silver coated union nut.

Lightly lubricate the soft-sealing element located on the 24° taper of the cutting ring (e.g. using hydraulic oil HLP32). Do not use lubricating grease!

Tighten the union nut to the point where there is a first increase in force. Then tighten the union nut to the end of the assembly.

Use a suitable spanner to hold the fitting body within the tube during the entire assembly process. Use a bench vice for assembly in the event of unfavourable assembly conditions or larger tube dimensions.

Immediately proceed with assembly to avoid the adhesion of dirt.

The cutting ring comes into contact with the face side of the fitting body after approx. 90°-120°. The end of the assembly is once again indicated by a significant increase in force.

A marking line on the union nut and the fitting body makes it easier to note and check the correct tightening angle.

Carefully insert the assembled tube end into the 24° taper of the fitting body.

6. Repeated Assembly

Check the soft-sealing element located on the 24° taper of the cutting ring for possible damage.

Then tighten the union nut to the end of the assembly. The cutting ring comes into contact with the face side of the fitting body after approx. 90°-120°. The end of the assembly is once again indicated by a significant increase in force.

Carefully insert the tube end into the 24° taper of the fitting body.



Assembly Instructions for 24° Tube Connectors with Soft-Sealing Cutting Ring (Type FI-WDDS/FI-WDDS-W5) Machine-Assisted Pre-Assembly with a STAUFF Press Assembly Machine and Assembly with the Fitting Body

1. Tube Preparation

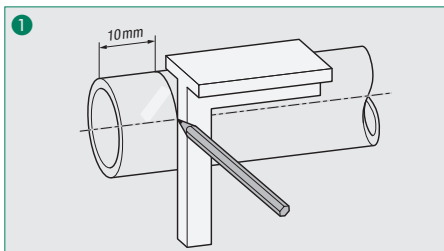

Saw off tube at a right angle (90°) and at least 10 mm from the cut made by the manufacture / supplier.

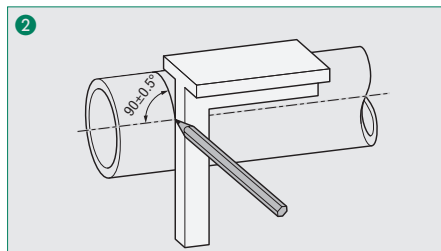

A maximum angular deviation of $\pm 0.5^\circ$ to the tube axis is permissible.

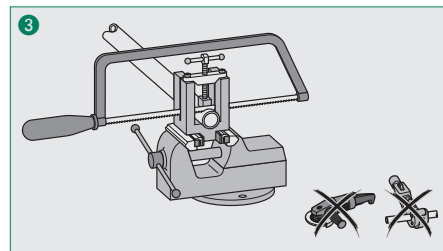

Do not use tube cutters or grinders.

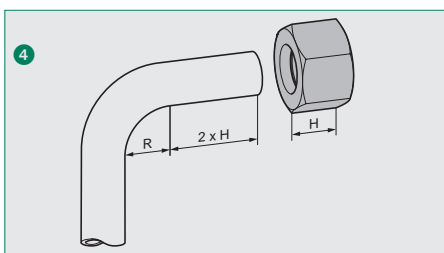

The length of the straight sections of the tube of tube bends has to be twice the length of the union nut.

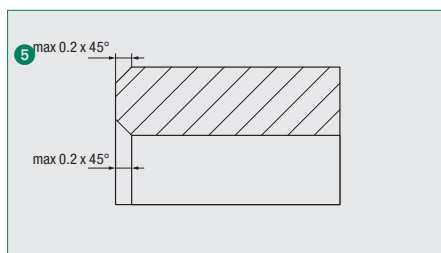

Slightly deburr the inside and outside of the tube end (max 0.2 x 45°). The assembly area of the tube has to be free of dirt, chips and paint.



Please note: Improperly prepared and contaminated tubes will affect the service life of the tube connectors and may result in leakage. Poorly deburred tube ends can result in damage to the internal O-ring!



Please note: Assembly of reinforcing sleeves is essential when using thin-walled tubes. Refer to page 310.

2. Assembly Preparation, Machine-Assisted Assembly and Inspection

Please refer to the detailed instructions in the operating manual for the machine with regard to assembly preparation, actual assembly and inspection of the assembled tube ends.



3. Final-Assembly with the Fitting Body

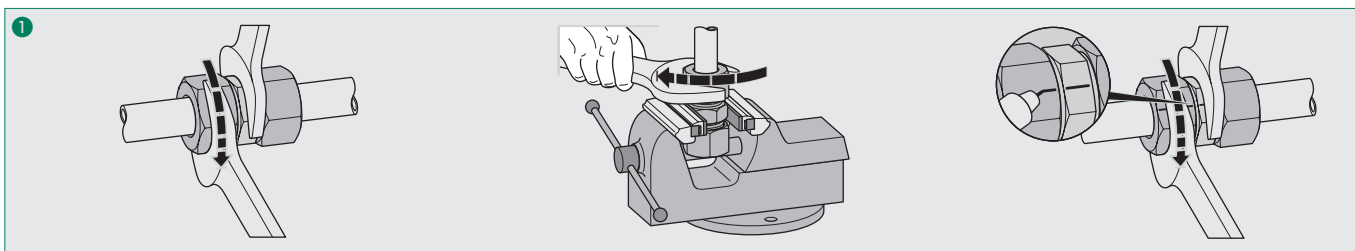

Please note when use FI-WDDS-W5 with Stainless Steel Fitting Body: Thread and 45° cone of the union nut and thread of the fitting body grease with special stainless steel fitting grease or use a silver coated union nut.

Lightly lubricate the soft-sealing element located on the 24° taper of the cutting ring (e.g. using hydraulic oil HLP32). Do not use lubricating grease!

Immediately proceed with assembly to avoid the adhesion of dirt.

Carefully insert the assembled tube end into the 24° taper of the fitting body.

Tighten the union nut to the point where there is a first increase in force. Then tighten the union nut to the end of the assembly.

The cutting ring comes into contact with the face side of the fitting body after approx. 90°-120°. The end of the assembly is once again indicated by a significant increase in force.

Use a suitable spanner to hold the fitting body within the tube during the entire assembly process. Use a bench vice for assembly in the event of unfavourable assembly conditions or larger tube dimensions.

A marking line on the union nut and the fitting body makes it easier to note and check the correct tightening angle.

6. Repeated Assembly

Check the soft-sealing element located on the 24° taper of the cutting ring for possible damage.

Carefully insert the tube end into the 24° taper of the fitting body.

Then tighten the union nut to the end of the assembly. The cutting ring comes into contact with the face side of the fitting body after approx. 90°-120°. The end of the assembly is once again indicated by a significant increase in force.



Please note when use FI-WDDS-W5 with Stainless Steel Fitting Body: Thread and 45° cone of the union nut and thread of the fitting body grease with special stainless steel fitting grease or use a silver coated union nut.



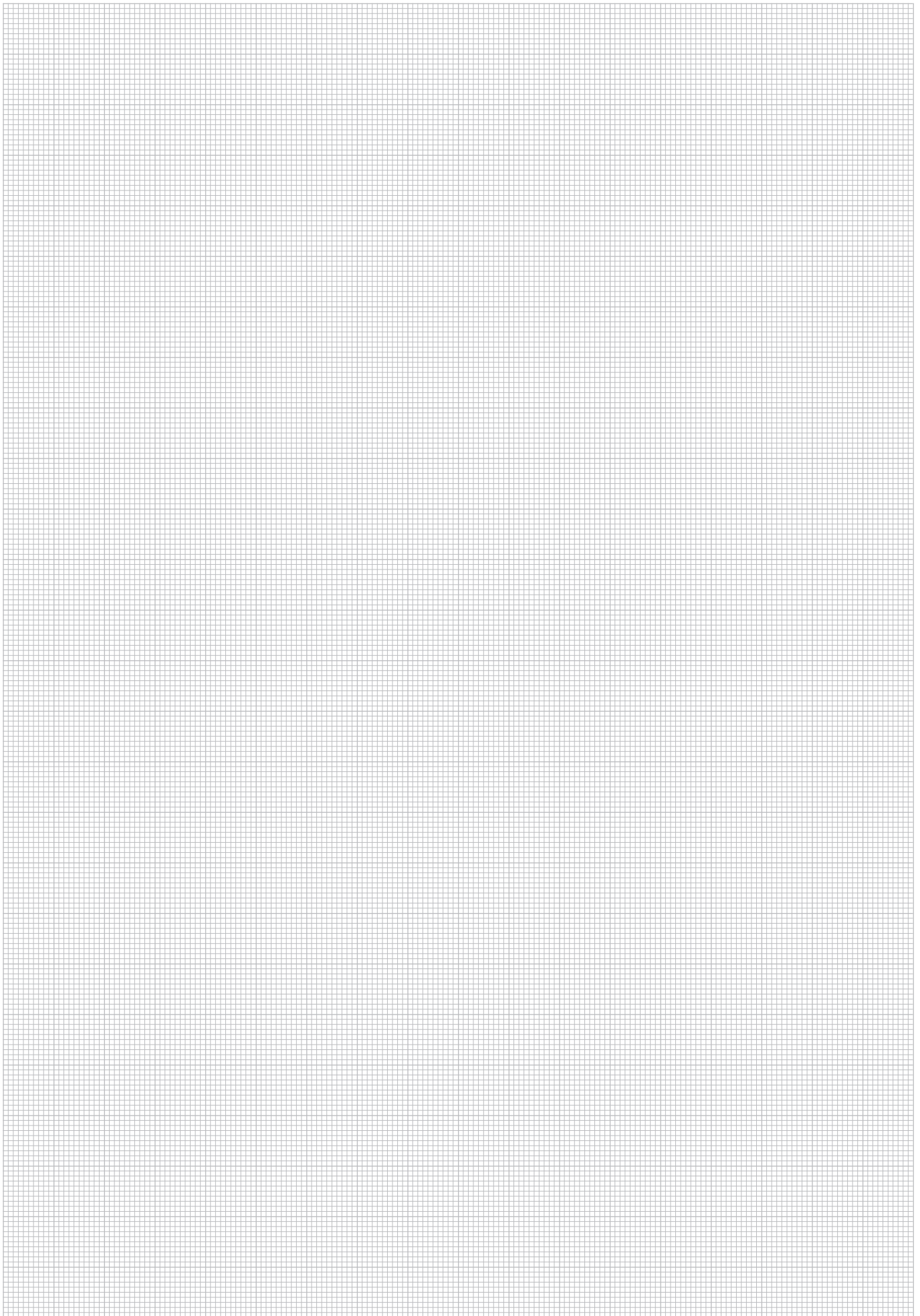

S



Assembly Instructions for Support Sleeves (Type FI-VH)

Selection Chart for Tubes made of Steel / Stainless Steel

Series	Tube OD mm	Tube Wall Thickness mm									
		0,5	0,75	1,0	1,5	2,0	2,5	3,0	3,5	4,0	
LL	4										
	6	●									
	8	●									
L	6	●	●								
	8	●	●								
	10	●	●								
	12	●	●	○							
	15	●	●	●							
	18	●	●	●	○						
	22	●	●	●	○	○					
	28	●	●	●	○	○	○				
	35	●	●	●	●	○	○	○			
	42	●	●	●	●	○	○				
S	6	●	●								
	8	●	●								
	10	●	●								
	12	●	●	○							
	14	●	●	●							
	16	●	●	●	○						
	20	●	●	●	●	○					
	25	●	●	●	●	○					
	30	●	●	●	●	●	○				
	38	●	●	●	●	●	●	○	○		

Selection Chart for Tubes made of Non-Ferrous Metals

Series	Tube OD mm	Tube Wall Thickness mm									
		0,5	0,75	1,0	1,5	2,0	2,5	3,0	3,5	4,0	
LL	4										
	6	●	●								
	8	●	●								
L	6	●	●	●							
	8	●	●	●							
	10	●	●	●	○						
	12	●	●	●	●						
	15	●	●	●	●						
	18	●	●	●	●	●					
	22	●	●	●	●	●	●				
	28	●	●	●	●	●	●	●			
	35	●	●	●	●	●	●	●	●		
	42	●	●	●	●	●	●	●	●	●	
S	6	●	●	●							
	8	●	●	●							
	10	●	●	●							
	12	●	●	●							
	14	●	●	●	●						
	16	●	●	●	●	●					
	20	●	●	●	●	●	●				
	25	●	●	●	●	●	●	●			
	30	●	●	●	●	●	●	●	●		
	38	●	●	●	●	●	●	●	●	●	●

● Generally required ○ Highly recommended, especially for adverse operating conditions (vibrations, risks of self-loosening of fittings etc.)

Support sleeves are generally required for use with tubes made of plastics.

Assembly

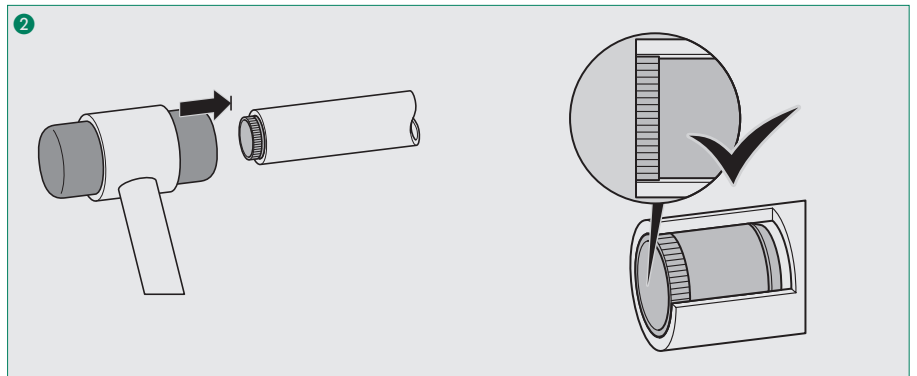
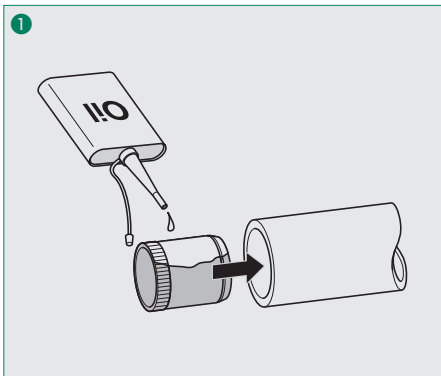

Lubricate the outside of the support sleeve (e.g. using mineral-oil based hydraulic fluid HLP32) and insert it into the tube end up to the knurled section.

Use a hammer (plastic or rubber) to fully drive the support sleeve into the tube end, so that the knurled section is pressed against the inner wall of the tube and the sleeve is firmly flush with the tube end.

In doing so, the support sleeve is prevented from subsequent turning, sliding and falling out.

S



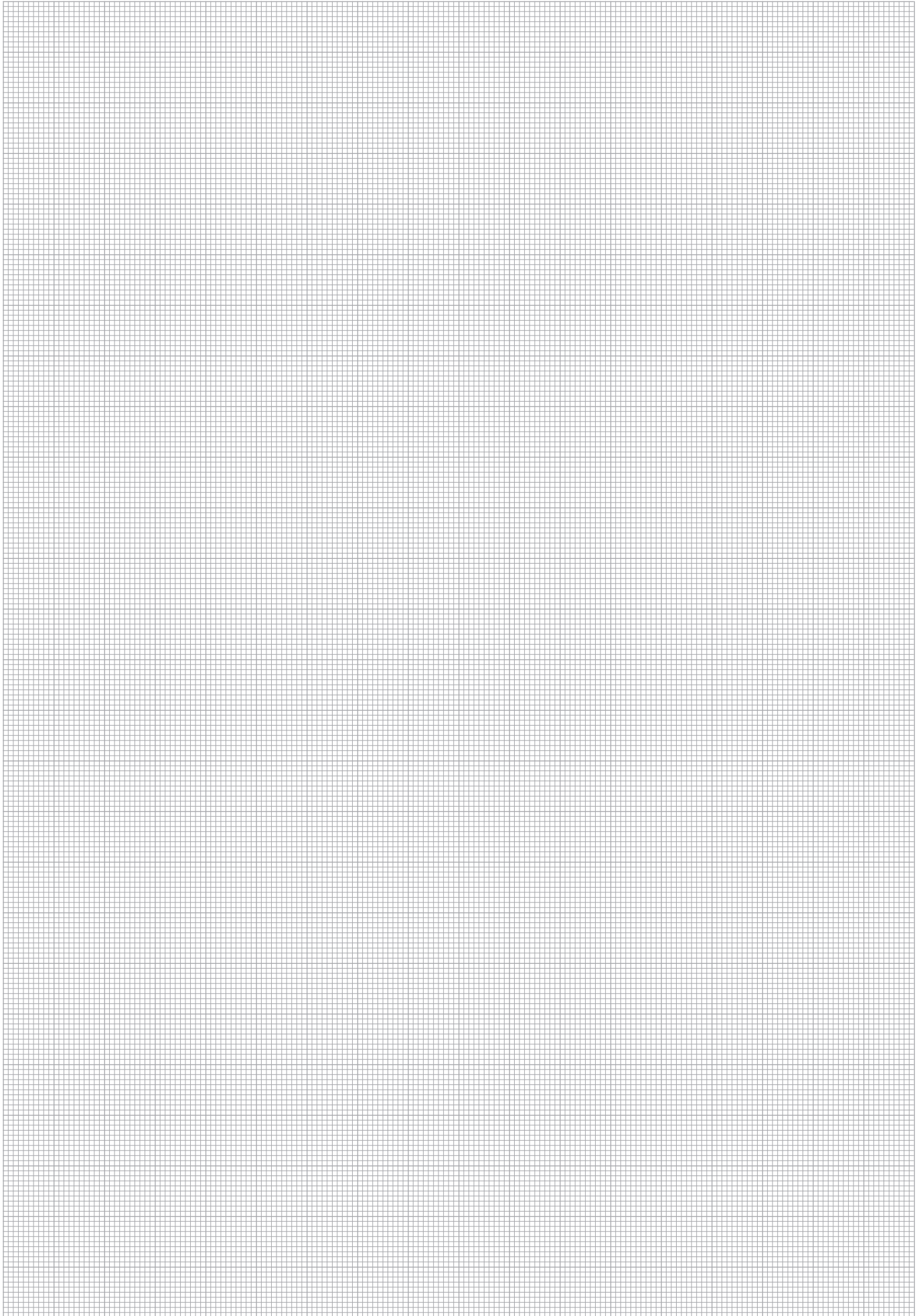

S



Assembly Instructions for STAUFF Form EVO Tube Fittings

Tube End Forming with a STAUFF Form EVO Machine and Assembly with the Fitting Body

1. Tube Preparation

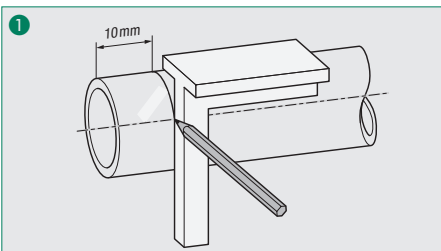

Saw off tube in right angle and at least 10 mm from the cut made by the tube manufacturer / supplier in order to avoid failures caused during shipment.

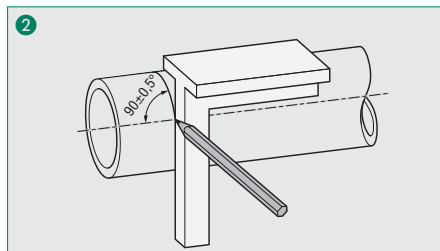

A maximum angular deviation / tolerance of $\pm 0,5^\circ$ relative to the tube axis is permissible.

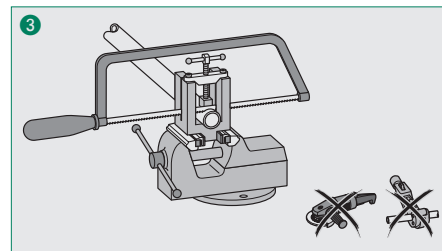

Only use proper tube sawing machinery or equipment. Do not use tube cutters or grinders as this may result in unwanted angled cuts and cause severe burring.

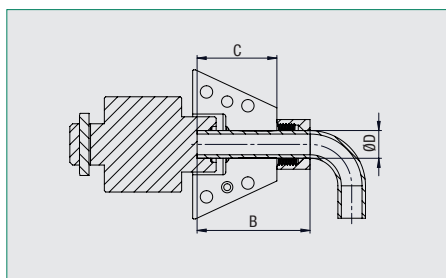
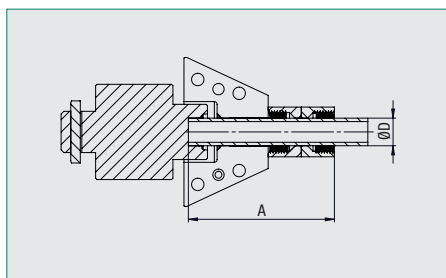

Series	Tube OD mm	Minimum Length A	Minimum Length B	Insertion Depth C incl. 10 mm Door thickness mm
		Straight Tube Ends mm	Straight Sections next to Tube Bends mm	
L	6	75	52	52
	8	75	52	52
	10	74	52	52
	12	75	54	54
	15	89	66	59
	18	99	74	67
	22	106	82	72
	28	112	87	75
S	35	138	106	81
	42	139	106	81
	6	77	54	54
	8	77	54	52
	10	77	54	52
	12	78	56	54
	16	98	72	61
	20	115	84	70
	25	129	96	79
	30	148	111	82
38	170	126	94	

Please note the minimum lengths for straight tube ends (dimension A) as well as for straight tube sections next to tube bends (dimension B) that are listed in the table.

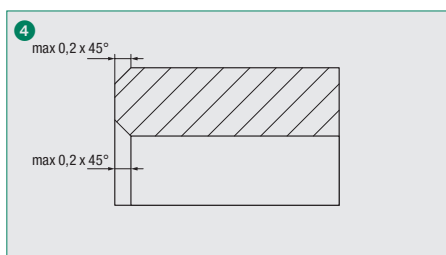

Slightly deburr inside and outside of the tube end (max 0,2 x 45°). The assembly area of the tube has to be free of contamination, chips and paint.



Please note: Improperly prepared and contaminated tubes will affect the service life of the connection and may result in leakage.



2. Preparation and Machine-Assisted Tube Forming

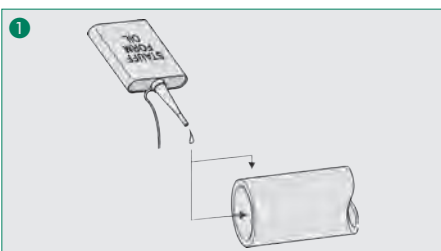

Lightly lubricate the inside and outside of the tube end (e.g. with a thin film of mineral-oil based hydraulic fluid HLP32) before starting the machine-assisted tube forming process. Do not use lubricating grease!

Important: For tube ends made of stainless steel, always and only use original STAUFF Form EVO Oil. The use of any other fluid is not allowed and may result in damage of the assembly tools.

Immediately proceed with the assembly in order to avoid exposure to contamination.

If the lubricant film on the outside of the tube end is too thick, fluid will be trapped between the forming tool and the tube end, thus resulting in inaccurate contours.

With regards to the actual tube forming process, please follow the detailed instructions in the operating manual of the machine.



Assembly Instructions for STAUFF Form EVO Tube Fittings

Tube End Forming with a STAUFF Form EVO Machine and Assembly with the Fitting Body

3. Inspection

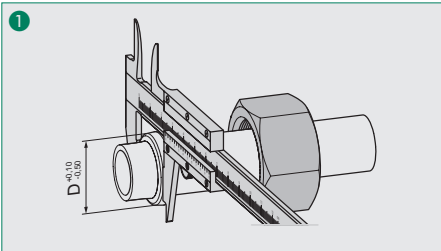

Use a suitable measuring device (caliper gauge) to check control diameter D of the formed tube end based on the dimension table on the right.

Series	Tube OD	Dimensions
	mm	D mm
L	6	9,5
	8	12,1
	10	14,0
	12	16,1
	15	20,1
	18	23,7
	22	27,1
	28	33,1
	35	42,1
	42	49,4
S	6	9,5
	8	12,1
	10	14,0
	12	16,1
	16	21,7
	20	26,1
	25	31,1
	30	37,1
38	46,9	

4. Assembly with the Fitting Body

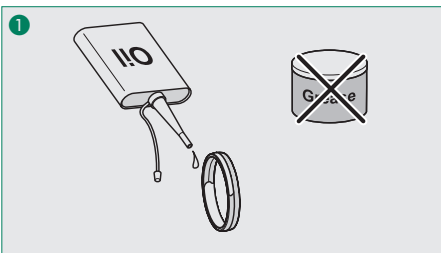

Lightly lubricate the inside and outside of the sealing element of the form ring (e.g. using mineral-oil based hydraulic fluid HLP32). Do not use lubricating grease!

Immediately proceed with the assembly in order to avoid exposure to contamination.

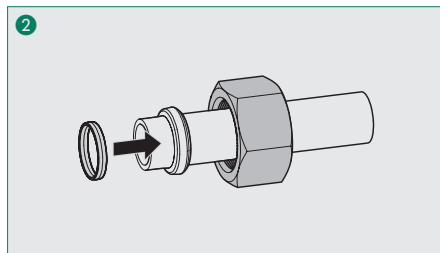

Slide the sealing ring onto the formed tube end (laterally identical profile to avoid assembly errors).

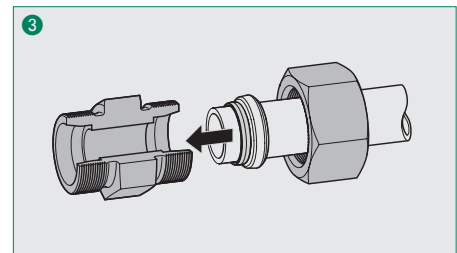

Carefully insert the formed tube end with the assembled sealing into the 24° taper of the fitting body.

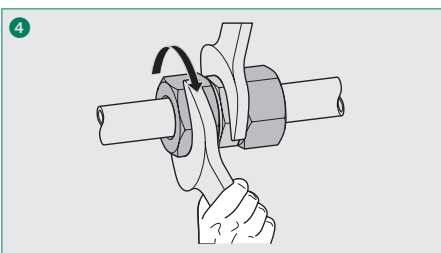

Use a suitable spanner to tighten the nut until there is a noticeable increase in force required (fixed point).

Avoid over-tightening by gripping the spanner close to the union nut.

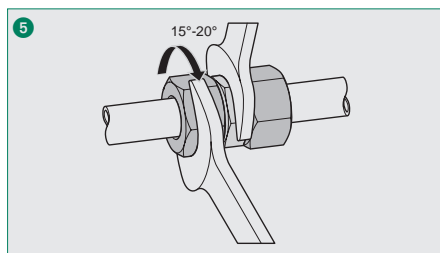

Finish the assembly by using a suitable spanner to tighten the union nut approximately 15-20° beyond the fixed point. Always use a second spanner to hold the fitting body during the entire assembly procedure.

Alternatively, the assembly can be done via a torque.
Table with torques see point 6.

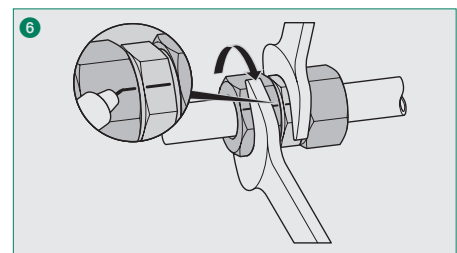

A marking line applied on the union nut and the fitting body makes it easier to indicate the sufficient tightening angle.



Please note when using stainless steel components: Thread and 45° cone of the union nut and thread of the fitting body grease with special stainless steel fitting grease or use a silver coated union nut.

5. Repeated Assembly

For repeated assemblies, please follow the instructions from point 4 on.



S

Assembly Instructions for STAUFF Form EVO Tube Fittings
 Tube End Forming with a STAUFF Form Machine and Assembly with the Fitting Body

6. Torques for alternative assembly for STAUFF Form EVO Tube Fittings

Series	Tube OD mm	Dimensions mm Thread	Turn till increase in force (fix point), than Assembly Angle	Torque N-m
L	6	M 12 x 1,5	15° ... 20°	23
	8	M 14 x 1,5		32
	10	M 16 x 1,5		40
	12	M 18 x 1,5		50
	15	M 22 x 1,5		65
	18	M 26 x 1,5		110
	22	M 30 x 2		120
	28	M 36 x 2		160
	35	M 45 x 2		275
	42	M 52 x 2		410
S	6	M 14 x 1,5		30
	8	M 16 x 1,5		40
	10	M 18 x 1,5		55
	12	M 20 x 1,5		60
	16	M 24 x 1,5		85
	20	M 30 x 2		160
	25	M 36 x 2		200
	30	M 42 x 2		270
	38	M52 x 2	400	



Assembly Instructions for STAUFF Form EVO Tube Fittings

Tube End Forming with a STAUFF Form EVO Machine and Assembly with the Fitting Body

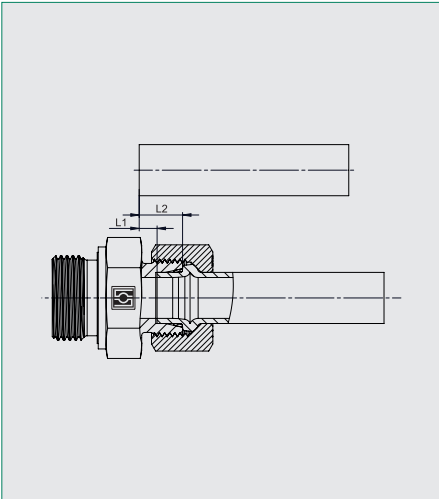
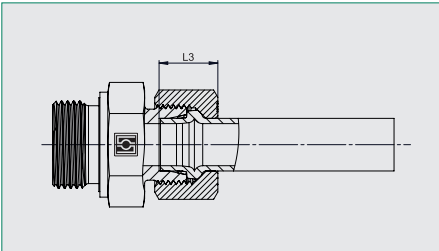
Calculation Dimensions

Tube OD mm	Tube Wall Thickness mm	L1 mm	L2 mm	L3 mm
6	1,5	7,3	13,8	14,6 (L+S)
8	1,5	7,5	14,0	14,6 (L+S)
	2,0	7,1	13,6	
10	2,5	6,6	13,1	14,5 (L) 15,5 (S)
	1,5	6,0	12,4	
	2,0	6,3	12,7	
12	2,5	6,0	12,4	14,6 (L) 15,6 (S)
	3,0	5,7	12,1	
	1,5	5,2	11,7	
	2,0	5,4	11,9	
15	2,5	5,1	11,6	15,6
	3,0	4,9	11,4	
	1,5	6	12,5	
16	2,0	6,4	12,9	18,4
	2,5	6,4	12,9	
	2,0	7,4	15,3	
	2,5	7,0	14,9	
18	3,0	7,0	14,9	16,4
	4,0	6,2	14,1	
	1,5	6,2	14,1	
	2,0	6,8	13,7	
	2,5	6,5	13,4	
20	3,0	6,8	13,7	21,6
	4,0	6,4	13,3	
	2,0	7,7	17,7	
	2,5	7,8	17,8	
22	3,0	7,7	17,7	17,5
	4,0	7,3	17,3	
	2,0	5,5	12,5	
	2,5	5,7	12,7	
25	3,0	5,8	12,8	24,5
	3,5	5,9	12,9	
	2,0	7,1	18,6	
	2,5	7,6	19,1	
	3,0	7,7	19,2	
	3,5	7,7	19,2	
28	4,0	7,8	19,3	18
	5,0	7,8	19,3	
	2,0	5,4	12,4	
	2,5	5,8	12,8	
	3,0	5,7	12,7	
30	3,5	5,3	12,3	27,2
	4,0	6,2	13,2	
	2,5	7,9	20,8	
	3,0	8,0	20,9	
	4,0	8,2	21,1	
	5,0	8,5	21,4	
35	6,0	8,2	21,1	22
	2,5	7,7	17,6	
	3,0	7,8	17,7	
	4,0	8,6	18,5	
38	5,0	8,7	18,6	31
	3,0	9,8	25,2	
	4,0	11,0	26,4	
	5,0	11,3	26,7	
42	6,0	11,4	26,8	22,7
	3,0	8,1	18,5	
	3,5	7,9	18,3	
	4,0	8,6	19,0	



Assembly Instructions for STAUFF Connect 37° Flared Tube Fittings

Tube Flaring with a STAUFF Press Machine and Assembly with the Fitting Body

1. Tube Preparation

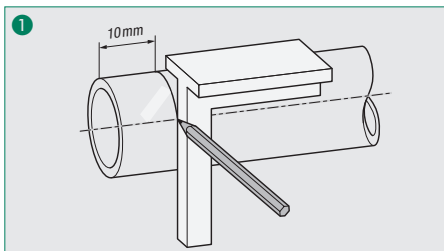

Saw off tube in right angle and at least 10 mm from the cut made by the tube manufacturer / supplier in order to avoid failures caused during shipment.

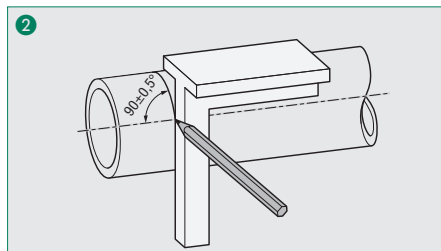

A maximum angular deviation / tolerance of $\pm 0,5^\circ$ relative to the tube axis is permissible.

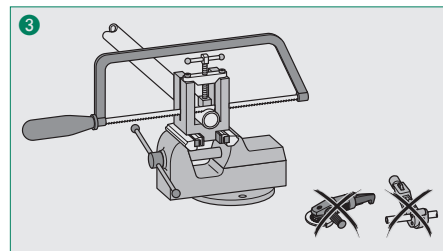

Only use proper tube sawing machinery or equipment. Do not use tube cutters or grinders as this may result in unwanted angled cuts and cause severe burring.

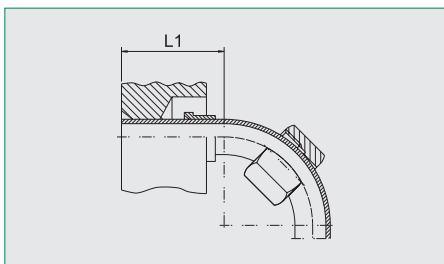
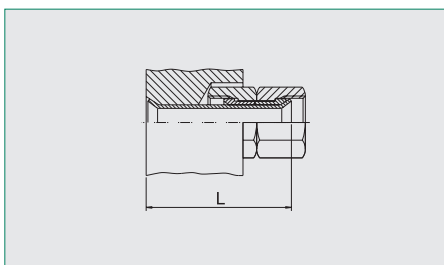

Series	Tube OD mm	Minimum Length L Straight Tube Sections mm	Minimum Length L1 Straight Tube Sections next to Tube Bends mm
L	6	59	43
	8	62	44
	10	64	46
	12	67	47
	15	75	50
	18	76	58
	22	81	60
	28	88	60
	35	92	62
	42	130	70
S	6	61	43
	8	64	44
	10	66	46
	12	68	47
	16	79	52
	20	82	58
	25	94	60
	30	96	62
38	136	70	

Please note the minimum lengths for straight tube ends (dimension L) as well as for straight tube sections next to tube bends (dimension L1) that are listed in the table. If installation situations demand that the length of straight tube sections next to tube bends (dimension L1) has to be shorter than indicated in the table, tube bending has to be carried out after flaring.

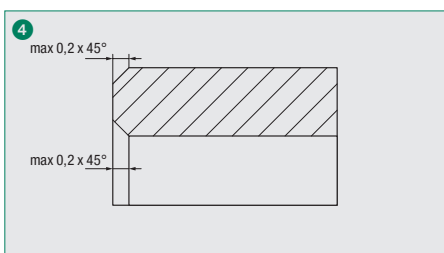

Slightly deburr inside and outside of the tube end (max 0,2 x 45°). The assembly area of the tube has to be free of contamination, chips and paint.



Please note: Improperly prepared and contaminated tubes will affect the service life of the connection and may result in leakage.

2. Preparation and Machine-Assisted Tube Flaring

With regards to assembly preparation as well as the actual tube flaring process, please follow the detailed instructions in the operating manual of the machine.



Assembly Instructions for STAUFF Connect 37° Flared Tube Fittings

Tube Flaring with a STAUFF Press Machine and Assembly with the Fitting Body

3. Inspection

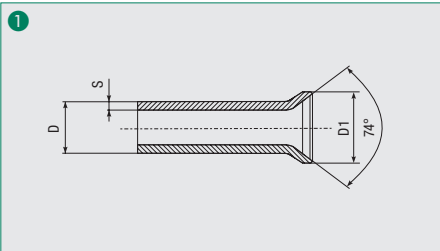

Check the flared tube end for cracking and impurities after flaring.

Always verify the dimensional accuracy of the flare.

The checking diameter corresponds to the outside diameter D1 of the flared tube end (according to dimension table on the right). The flare must be at right angle to the tube axis and concentric with the tube.

Please note: If the flare is eccentric, too short or not wide enough, perfect function of the tube fitting cannot be guaranteed!

4. Assembly with the Fitting Body

Lubricate the o-rings of the 24°/37° flared tube adaptor (e.g. using mineral-oil based hydraulic fluid HLP32) and carefully insert it into the 24° taper of the fitting body.

It is recommended to use a bench vice to press and permanently capture the 24°/37° flared tube adaptor into the 24° taper of the tube fitting – a great help to the tube fitter during re-assembly. In this case, please make sure that all components are suitably protected against damage.

Apply the flared tube end to the 24°/37° flared tube adaptor, which is attached to the fitting body, tighten the union nut until the noticeable increase in force, and then finish the assembly with another approximately 1/2 a turn (180°) beyond this point.

Important: Always use a spanner to hold the fitting body during the assembly procedure.

Tube OD D mm	Dimensions S mm	D1 _{min} mm	D1 _{max} mm
6	1	9,1	10
	1,5		
8	1	11,3	12
	1,5		
	2		
10	1	13,1	14
	1,5		
	2		
12	1	15,3	16
	1,5		
	2		
14	1,5	18,6	19,6
	2		
	2,5		
	3		
15	1,5	19,1	20
	2		
	2,5		
16	1,5	20,6	22
	2		
	2,5		
	3		
18	1,5	23,2	24
	2		
	2,5		
20	2	25,6	26,8
	2,5		
	3		
	3,5		
	1,5		
22	2	26,5	27,5
	2,5		
	3		
	3		
25	2	31,1	33
	2,5		
	3		
	4		
	2		
28	2,5	32,7	33,3
	3		
	2		
30	2,5	37	38,7
	3		
	4		
	5		
	2		
35	2,5	41,8	42,7
	3		
	4		
	2,5		
38	3	46	47,2
	4		
	5		
	2		
	3		
42	3	48,8	49,8
	4		
	4		

5. Repeated Assembly

For repeated assembly, the union nut has to be tightened using exactly the same force as for the original assembly.



Assembly Instructions for STAUFF Connect 37° Flared Tube Fittings

Tube Flaring with a STAUFF Press Machine and Assembly with the Fitting Body

Calculation Dimensions

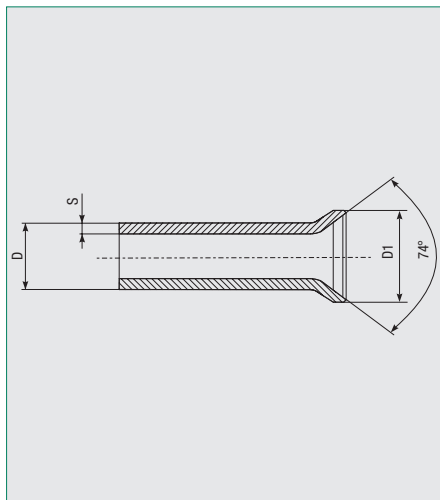
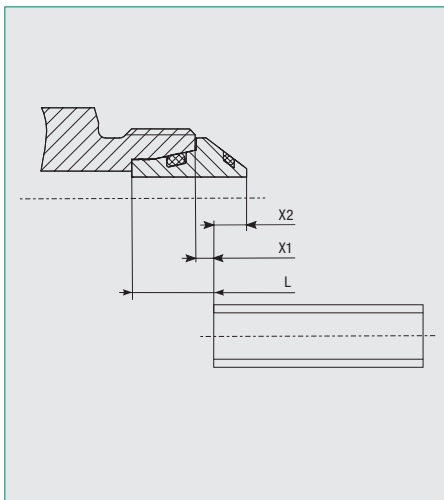

Tube OD mm D	Dimensions mm				D1 min	D1 max
	S	X1	X2	L		
6	1	1	3,5	8	9,1	10
	1,5	2	2,5	9		
8	1	1	4	8	11,3	12
	1,5	2	3	9		
	2	2,5	2,5	9,5		
10	1	1	4,5	8	13,1	14
	1,5	2	3,5	9		
	2	3	2,5	10		
12	1	1	4,5	8	15,3	16
	1,5	2	3,5	9		
	2	3	2,5	10		
14	1,5	0,5	5,5	8,5	18,6	19,6
	2	1	5	9		
	2,5	2	4	10		
	3	3	3	11		
15	1,5	1	4,5	8	19,1	20
	2	2	3,5	9		
	2,5	3	2,5	10		
16	1,5	0	6,5	8,5	20,6	22
	2	1	5,5	9,5		
	2,5	1,5	5	10		
	3	2,5	4	11		
18	1,5	0	5,5	7,5	23,2	24
	2	1	4,5	8,5		
	2,5	1,5	4	9		
20	2	1	7	11,5	25,6	26,8
	2,5	2	6	12,5		
	3	3	5	13,5		
	3,5	4	4	14,5		
	1,5	1	5,7	8,5		
22	2	2	4,7	9,5	26,5	27,5
	2,5	3	3,7	10,5		
	3	3,5	3,2	11		
	3,5	4	2	13		
25	2,5	1,5	6,5	13,5	31,1	33
	3	2,5	5,5	14,5		
	4	4	4	16		
	2	1,5	5,7	9		
	2,5	2,5	4,7	10		
28	3	3	4,2	10,5	32,7	33,3
	2	-0,5	9	13		
	2,5	0,5	8	14		
30	3	1	7,5	14,5	37	38,7
	4	3	5,5	16,5		
	5	4,5	4	18		
	2	1,5	6,5	12		
	2,5	2	6	12,5		
35	3	3	5	13,5	41,8	42,7
	4	4,5	3,5	15		
	2,5	0	10	16		
	3	0,5	9,5	16,5		
38	4	2	8	18	46	47,2
	5	4	6	20		
	2	1,5	7	12,5		
	3	3	6,5	14		
42	4	4,5	5	15,5	48,8	49,8

The correct tube length can be determined by measuring the distance between the 24°/37° flared tube adaptors pressed into the fitting bodies. Dimension X2 has then to be added for each of the connections.

The correct tube length can also be determined by measuring the distance between the fitting bodies. Dimension X1 has then to be subtracted for each of the connections.

Dimension L corresponds to the difference in tube length compared to cutting ring fittings. When changing over from cutting ring fittings to flared tube fittings, the tube has to be shortened by dimension L.

Always verify the dimensional accuracy of the flare. The checking diameter corresponds to the outside diameter D1 of the flared tube end (according to dimension table on the right). The flare must be at right angle to the tube axis and concentric with the tube. Please note: If the flare is eccentric, too short or not wide enough, perfect function of the tube fitting cannot be guaranteed!



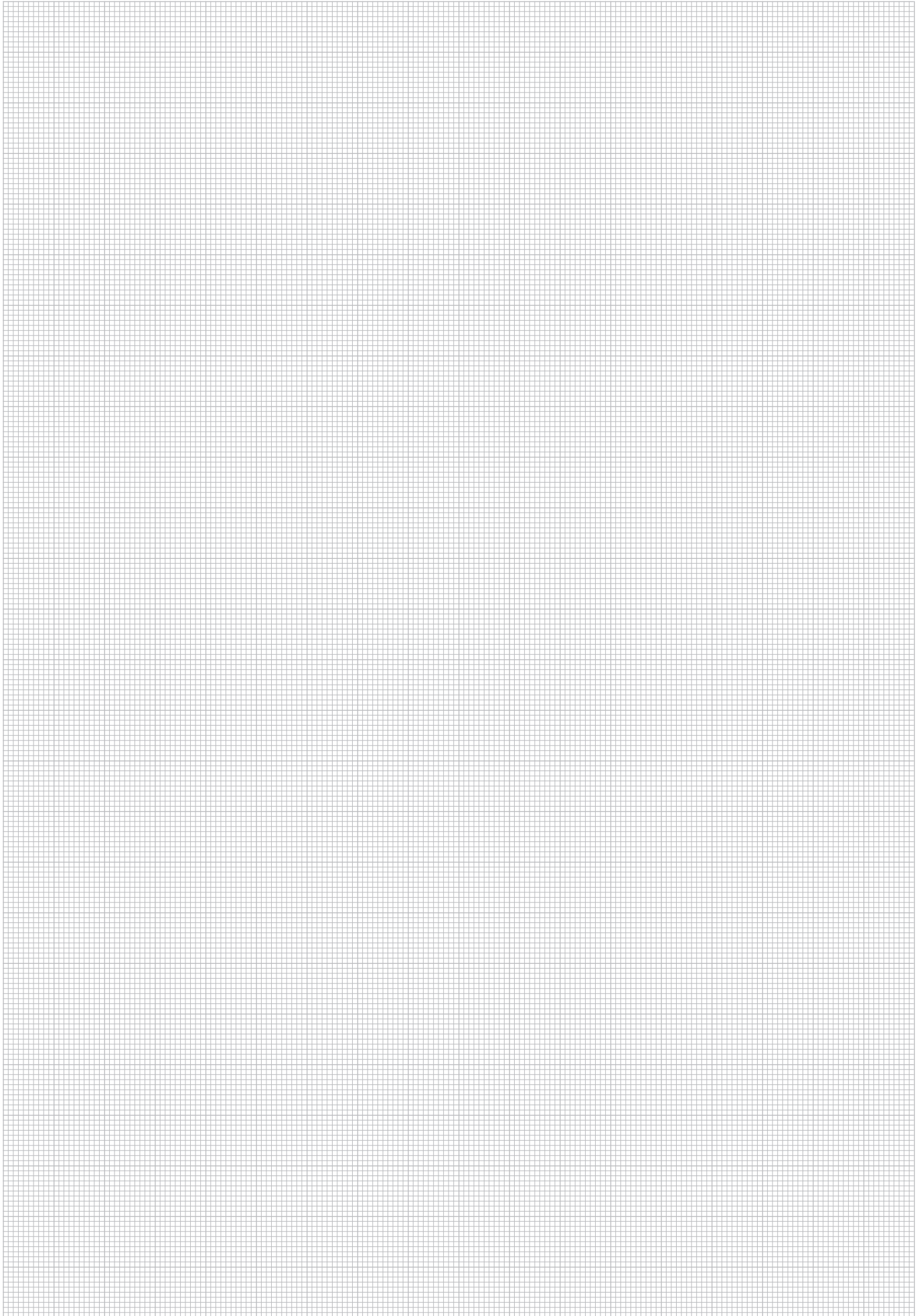

S



Assembly Instructions for 24° Weld Cones with O-Ring

1. Tube Preparation

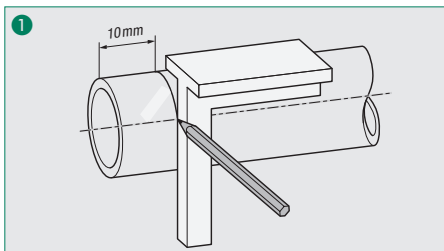

Saw off tube in right angle and at least 10 mm from the cut made by the tube manufacturer / supplier in order to avoid failures caused during shipment.

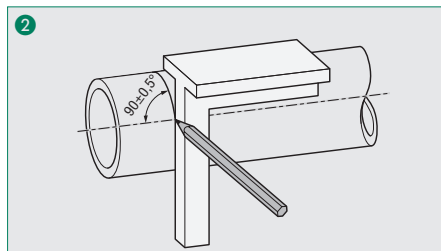

A maximum angular deviation / tolerance of $\pm 0,5^\circ$ relative to the tube axis is permissible.

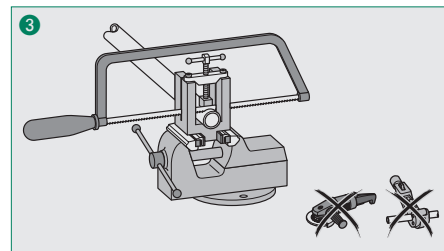

Only use proper tube sawing machinery or equipment. Do not use tube cutters or grinders as this may result in unwanted angled cuts and cause severe burring.

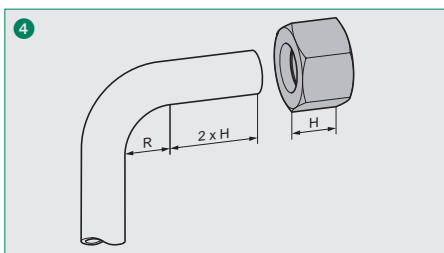

For tube bends, the length of the straight section of the tube end to the start of the bending radius has to be twice the height of the union nut.

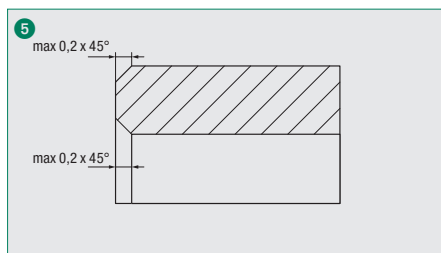

Slightly deburr inside and outside of the tube end (max $0,2 \times 45^\circ$). The assembly area of the tube has to be free of contamination, chips and paint.



Please note: Improperly prepared and contaminated tubes will affect the service life of the connection and may result in leakage.

2. Assembly Preparation and Welding

Place the union nut on the weld cone.

The user is fully responsible for the quality of the welding work.

Lubricate the o-ring of the weld cone (e.g. using mineral-oil based hydraulic fluid HLP32). Do not use lubricating grease!

Remove the o-ring from the front end of the weld cone before welding (usually supplied separately).

Descal the welded area and clean the o-ring groove.

Immediately proceed with the assembly in order to avoid exposure to contamination.

Weld the weld cone and the tube end according to any applicable guidelines for welding.

Assemble the o-ring and make sure that it is located in the groove of the weld cone without being twisted.

3. Assembly with the Fitting Body

Carefully insert the weld cone into the 24° taper of the fitting body.

Tighten the union nut until the noticeable increase in force.

A marking line applied on the union nut and the fitting body makes it easier to indicate the sufficient tightening turns.

Then finish the assembly with another approximately 1/3 a turn (120°) beyond this point.

S

4. Repeated Assembly

For repeated assembly, the union nut has to be tightened using exactly the same force as for the original assembly.

The o-ring has to be checked for possible damages and, if necessary, replaced prior to the re-assembly.



Assembly Instructions for 24° Weld Cones with O-Ring

Calculation Dimensions

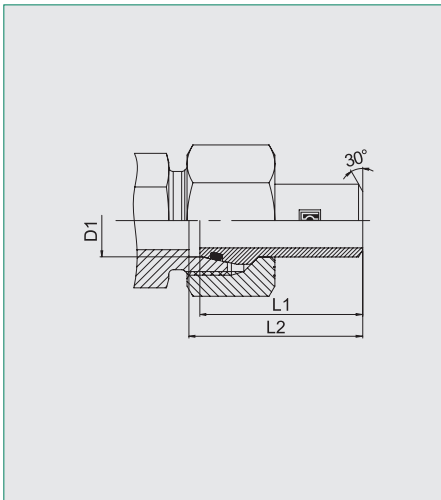

Series	Tube OD	Dimensions	
	D1 mm	L1 mm	L2 mm
L	6	31	32
	8	31	32
	10	32,5	33,5
	12	32,5	33,5
	15	35	36
	18	36	37
	22	38,5	39,5
	28	41,5	42,5
	35	47	49,5
	42	47	50
	S	6	31
8		31	32
10		32,5	33,5
12		32,5	33,5
14		38,5	39,5
16		39	41
20		44,5	47
25		49,5	53,5
30		52,5	57,5
38		56,5	64,5



Assembly Instructions for Tube Fittings with 24° Taper and O-Ring

1. Assembly Preparation

Make sure that the o-ring is located in the groove of the taper without being twisted.

Lubricate the o-ring of the taper fitting (e.g. using mineral-oil based hydraulic fluid HLP32). Do not use lubricating grease!

Immediately proceed with the assembly in order to avoid exposure to contamination.

2. Assembly with the Fitting Body

Keep the taper fitting aligned and carefully insert it into the 24° taper of the fitting body.

Tighten the wire-pin nut until the noticeable increase in force, and then finish the assembly with another approximately 1/3 a turn (120°) beyond this point.

A marking line applied on the nut and the fitting body makes it easier to indicate the sufficient tightening turns.

Important: Always use a spanner to hold the fitting body during the assembly procedure.

Series	Tube OD (mm)	Dimensions (mm) Thread	Turn till increase in force, then Assembly Angle	Torque (N-m)
L	6	M 12 x 1,5	120° (1/3 turns)	20
	8	M 14 x 1,5		30
	10	M 16 x 1,5		40
	12	M 18 x 1,5		50
	15	M 22 x 1,5		65
	18	M 26 x 1,5		110
	22	M 30 x 2		120
	28	M 36 x 2		160
	35	M 45 x 2		275
	42	M 52 x 2		410
S	6	M 14 x 1,5		30
	8	M 16 x 1,5		40
	10	M 18 x 1,5		50
	12	M 20 x 1,5		70
	14	M 22 x 1,5		78
	16	M 24 x 1,5		85
	20	M 30 x 2		160
	25	M 36 x 2		200
	30	M 42 x 2		270
	38	M 52 x 2		400

Assembly Instructions for Tube Fittings with Standpipe

1. Assembly Preparation

Standpipe fittings are always supplied with factory-assembled cutting rings and union nuts.

2. Assembly with the Fitting Body

Keep the fitting with standpipe aligned and carefully insert it into the 24° taper of the fitting body.

Tighten the union nut until the noticeable increase in force, and then finish the assembly with another approximately 1/12 a turn (30°) beyond this point.

Important: Always use a spanner to hold the fitting body during the assembly procedure.

A marking line applied on the nut and the fitting body makes it easier to indicate the sufficient tightening turns.

S



Assembly Instructions for Tube Fittings with Male Threaded Stud Whitworth Parallel Pipe Thread

Tightening Torques

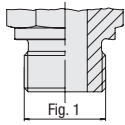
Metallic Sealing Edge

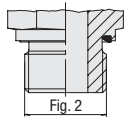
 Whitworth Parallel Pipe Thread
DIN 3852-2 (Form B) / ISO 1179-4 (Type B)

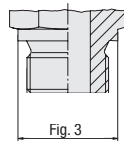
Profile Sealing Ring

 Whitworth Parallel Pipe Thread
ISO 1179-2 (Type E)

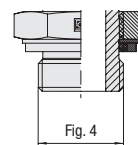
Sealing Surface for Gaskets

Whitworth Parallel Pipe Thread

**O-Ring with Retaining Ring
(Adjustable)**

Whitworth Parallel Pipe Thread

Series	Thread	Male Threaded Studs			Check Valves	Adjustable Male Threaded Studs	Blanking Screws		
		fig. 1 Metallic Sealing Edge Torque (N-m) ca.	fig. 2 Profile Sealing Ring Torque (N-m) ca.	fig. 3 Sealing Surface for Gaskets Torque (N-m) ca.	fig. 2 Profile Sealing Ring Torque (N-m) ca.	fig. 4 O-Ring with Retaining Ring Torque (N-m) ca.	FI-VSV fig. 2 Profile Sealing Ring Torque (N-m) ca.	FI-VS fig. 1 Metallic Sealing Edge Torque (N-m) ca.	fig. 2 Profile Sealing Ring Torque (N-m) ca.
L	G 1/8	25	18	20	18	25	18	25	15
	G 1/4	55	35	50	35	50	33	40	25
	G 3/8	95	70	80	70	80	70	95	50
	G 1/2	185	90	140	90	105	90	130	70
	G 3/4	250	180	190	180	220	180	250	120
	G 1	400	310	330	310	370	250	400	200
	G 1 1/4	670	450	540	450	500	400	600	320
S	G 1 1/2	800	540	630	540	600	500	800	400
	G 1/8	30	25				18	25	15
	G 1/4	80	55	60	55	50	33	40	25
	G 3/8	130	80	100	80	80	70	95	50
	G 1/2	220	115	160	115	105	90	130	70
	G 3/4	350	180	280	180	220	181	250	120
	G 1	700	310	440	310	370	250	400	200
	G 1 1/4	850	450	580	450	500	400	600	320
G 2	1200					500	800	400	

Please note: The tightening torques for male threaded studs listed in this catalogue are approximate values with a tolerance of +10% and always refer to original components of the STAUFF Connect range made of steel with the default Zinc/Nickel coating and a steel mating material.

Please contact STAUFF prior to the assembly for recommended tightening torques for use with any mating materials other than Steel!



Assembly Instructions for Tube Fittings with Male Threaded Stud Metric Parallel Thread

Tightening Torques

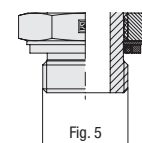
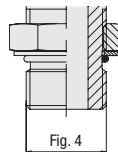
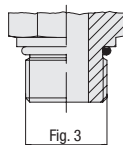
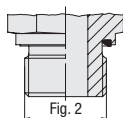
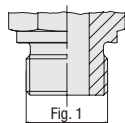

Metallic Sealing Edge

Profile Sealing Ring

O-Ring

**O-Ring without Retaining Ring
(Adjustable)**

**O-Ring with Retaining Ring
(Adjustable)**

Metric Parallel Thread
DIN 3852-1 (Form B) /
ISO 9974-3 (Type B)

Metric Parallel Thread
ISO 9974-2 (Type E)

Metric Parallel Thread
ISO 6149-2 /-3

Metric Parallel Thread
ISO 6149-2 /-3

Metric Parallel Thread

Series	Thread	Male Threaded Studs			Check Valves	Adjustable Male Threaded Studs		Blanking Screws		
		fig. 1 Metallic Sealing Edge Torque (N-m) ca.	fig. 2 Profile Sealing Ring Torque (N-m) ca.	fig. 3 O-Ring Torque (N-m) ca.	fig. 2 Profile Sealing Ring Torque (N-m) ca.	fig. 5 O-Ring with Retaining Ring Torque (N-m) ca.	fig. 4 O-Ring Torque (N-m) ca.	fig. 2 Profile Sealing Ring Torque (N-m) ca.	fig. 2 Profile Sealing Ring Torque (N-m) ca.	fig. 3 O-Ring Torque (N-m) ca.
L	M 8 x 1	14							10	
	M 10 x 1	25	18	15	18	18	15	12	12	15
	M 12 x 1,5	45	25	25	25	35	25	25	23	22
	M 14 x 1,5	70	45	35	45	55	35	45	30	45
	M 16 x 1,5	90	55	40	55	80	40	55	50	55
	M 18 x 1,5	120	70	45	70	105	45	70	65	70
	M 22 x 1,5	170	125	60	125	125	60	125	90	100
	M 26 x 1,5 ²	230	180		180			180	100	170
	M 27 x 2		180	100		200	100	180	130	180
	M 33 x 2	400	310	160	310	370	160	250	250	215
M 42 x 2	700	450	210	450	500	210	400	310	330	
M 48 x 2	900	540	260	540	600	260	500	380	420	
S	M 12 x 1,5	60	35	35	35	35	35	25	23	22
	M 14 x 1,5	80	55	40	55	55	45	45	30	45
	M 16 x 1,5	130	70	55	70	80	55	55	50	55
	M 18 x 1,5	190	90	70	90	105	70	70	65	70
	M 20 x 1,5	220	125		125			80	80	
	M 22 x 1,5	300	135	100	135	125	100	125	90	100
	M 26 x 1,5		180					180	100	170
	M 27 x 2	420	180	170	180	220	170	180	130	180
	M 33 x 2	600	310	310	310	370	310	250	250	215
	M 42 x 2	700	450	330	450	500	330	400	310	330
M 48 x 2	950	540	420	540	600	420	500	380	420	

²M 27 x 2 according to ISO 6149.

Please note: The tightening torques for male threaded studs listed in this catalogue are approximate values with a tolerance of +10% and always refer to original components of the STAUFF Connect range made of steel with the default Zinc/Nickel coating and a steel mating material.

S

Please contact STAUFF prior to the assembly for recommended tightening torques for use with any mating materials other than Steel!



Assembly Instructions for Tube Fittings with Male Threaded Stud UN/UNF-Thread

Tightening Torques

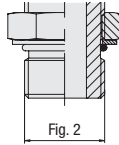
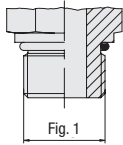

**O-Ring without Retaining Ring
(Non-Adjustable)**

**O-Ring without Retaining
Ring (Adjustable)**

UN/UNF-Thread

UN/UNF-Thread
ISO 11926-2/-3

Series	Thread	Male Threaded Studs	Adjustable Male Threaded Studs
		fig. 1 O-Ring Torque N-m ca.	fig. 2 O-Ring Torque N-m ca.
L	7/16-20 UNF	18	18
	1/2-20 UNF	28	
	9/16-18 UNF	30	34
	3/4-16 UNF	50	55
	7/8-14 UNF	60	80
	1 1/16-12 UN	95	100
	1 5/16-12 UN	150	150
	1 5/8-12 UN	200	290
S	1 7/8-12 UN	325	325
	7/16-20 UNF	20	20
	9/16-18 UNF	35	46
	3/4-16 UNF	70	80
	7/8-14 UNF	100	80
	1 1/16-12 UN	170	185
	1 5/16-12 UN	270	
	1 5/8-12 UN	285	340
1 7/8-12 UN	415	415	

Please note: The tightening torques for male threaded studs listed in this catalogue are approximate values with a tolerance of +10% and always refer to original components of the STAUFF Connect range made of steel with the default Zinc/Nickel coating and a steel mating material.

Please contact STAUFF prior to the assembly for recommended tightening torques for use with any mating materials other than Steel!



Assembly Instructions for Banjo Fittings

1. Assembly Preparation

Lubricate the o-ring of the banjo bolt (e.g. using mineral-oil based hydraulic fluid HLP32).
Do not use lubricating grease!

Immediately proceed with the assembly in order to avoid exposure to contamination.

2. Assembly with the Fitting Body

Place the external metallic sealing ring or the retaining ring with captive seal on the opposite side of the banjo fitting into the larger bore and center it through the thread for the banjo bolt. Retaining rings with captive seal are additionally centered through the bore in the fitting body – any clearance between the ring and the fitting body is not allowed.

Align the body of the banjo fitting and tighten the banjo bolt with a spanner until the noticeable increase in force (pressure point).

Use a suitable spanner to finish the assembly with either another approximately 1/6 a turn (60°, applicable for retaining rings with captive seal) or 1/4 a turn (90°, applicable for external metallic sealing rings) beyond this point while holding the body of the banjo fitting in position using a second spanner.

Positioning and Orientation of Retaining Rings with Captive Seal

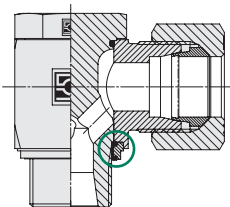

Applicable for RSWND / RSW / RST

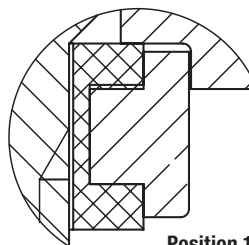

Position 1

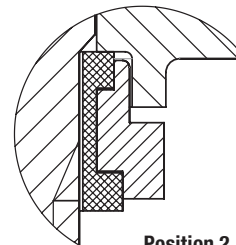

Position 2

Series	Tube OD mm	Thread	Position
L	6	G 1/8	2
	8	G 1/4	2
	10	G 1/4	2
	12	G 3/8	1
	15	G 1/2	1
	18	G 1/2	1
	22	G 3/4	1
	28	G 1	1
	35	G 1 1/4	1
	42	G 1 1/2	1
S	6	G 1/4	2
	8	G 1/4	2
	10	G 3/8	1
	12	G 3/8	1
	14	G 1/2	1
	16	G 1/2	1
	20	G 3/4	1
	25	G 1	1
	30	G 1 1/4	1
	38	G 1 1/2	1

Series	Tube OD mm	Thread	Position
L	6	M 10x1	2
	8	M 12x1,5	1
	10	M 14x1,5	2
	12	M 16x1,5	1
	15	M 18x1,5	1
	18	M 22x1,5	1
	22	M 26x1,5	1
	28	M 33x2	1
	35	M 42x2	1
	42	M 48x2	1
S	6	M 12x1,5	1
	8	M 14x1,5	2
	10	M 16x1,5	1
	12	M 18x1,5	1
	14	M 20x1,5	1
	16	M 22x1,5	1
	20	M 27x2	1
	25	M 33x2	1
	30	M 42x2	1
	38	M 48x2	1

S

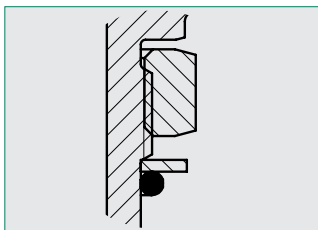
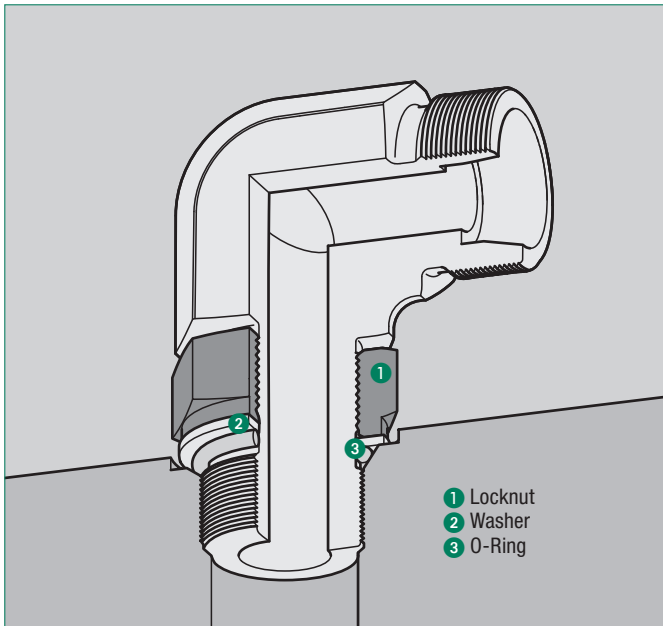
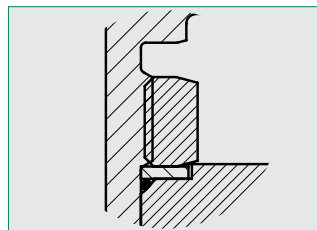
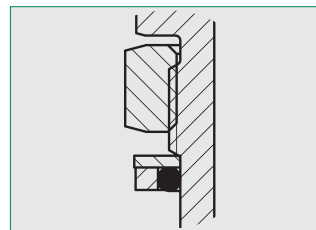
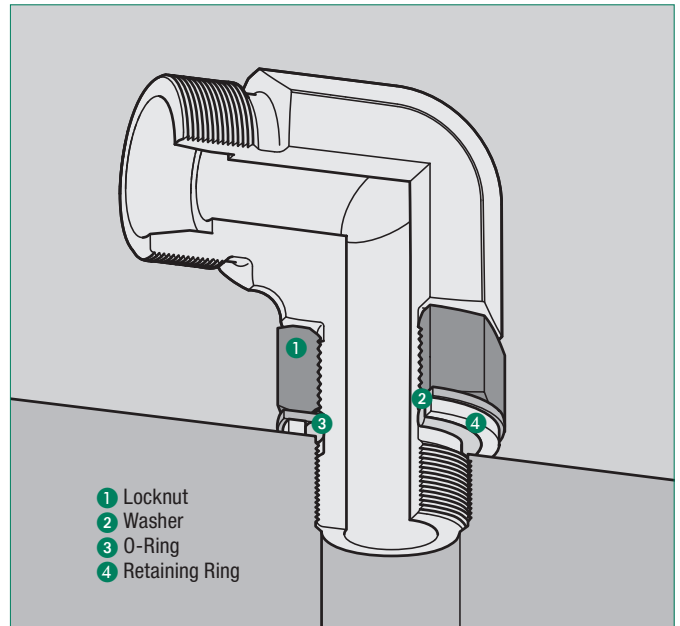
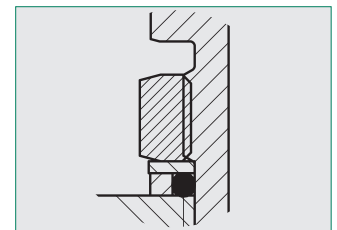
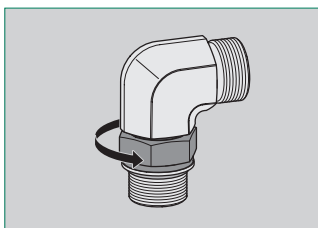

Assembly Instructions for Adjustable Fitting with Locknut (WEE, VEE, TEE, LEE)
For use in Ports to ISO 6149 and SAE UNO

Pre-assembly

Post-assembly
For use in Ports Form X acc. to DIN 3852-2, ISO 1179-1

Pre-assembly

Post-assembly
1. Assembly Preparation

Lubricate the o-ring (e.g. using mineral-oil based hydraulic fluid HLP32).
Do not use lubricating grease!

Immediately proceed with the assembly in order to avoid exposure to contamination.

Ensure that the Locknut, O-Ring and Washer are fully raised.

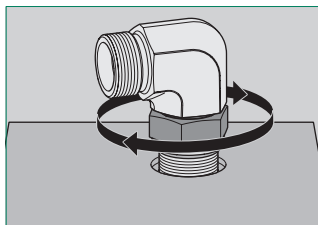

Please Note:
For use in Ports Form X, ensure that the Retaining Ring is placed.

2. Assembly

Fully screw in the fitting body.

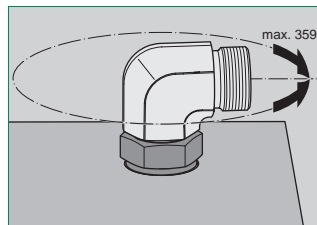

Adjust the direction.
Caution: Turn back by no more than one rotation against the direction in which the fitting body was installed!

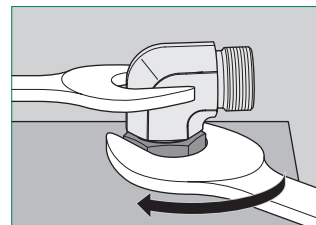

Tighten the locknut with the defined torque (see p. 171-179) while using a spanner to counter the fitting body in the direction of adjustment.

S



Tube Fitting Materials and Surface Finishings	330
Elastomer Seal Materials	331
Overview of media resistance	331
Pressure and Temperature Ratings	332
Pressure Reduction Factors	333
Calculated Design / Burst Pressures for Tube (bar)	334
Port Dimensions for Fittings with Male Threaded Stud	336
Dimensions of the 24° Conical Bore / Union Nut	339
Standard Threads and Widths Across Flats for Fittings with Male Threaded Stud	340
Certificates and Approvals	341



Tube Fitting Materials and Surface Finishings

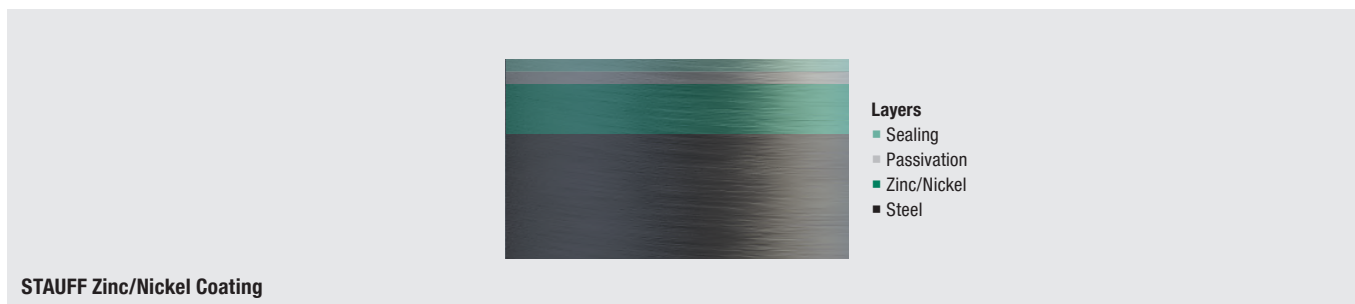

Fitting bodies of the STAUFF Connect range are usually machined from drawn or forged steel in accordance with DIN 3859-1 (Technical Specification for Tube Fittings).

Union nuts are either cold-pressed or hot-pressed.

Unless otherwise stated, all metal parts of the STAUFF Connect range of tube fittings are made of Steel with standard Zinc/Nickel coating (material code: W3), that offers excellent surface protection far beyond the market standard.

One of the few exceptions, weld fittings are made of Steel, phosphated (material code: W2).

Alternative surface coatings are available upon request.

Do not hesitate to contact STAUFF for further information.

Main Advantages of the STAUFF Zinc/Nickel Coating

- Premium long-life surface protection against corrosion with more than 1200 hours resistance to red rust / base metal corrosion in the salt-spray test according to DIN EN ISO 9227
- Free of hexavalent chrome Cr(VI)
- ELV compliant according to 2000/53/EC (End of Life Vehicles Directive)
- REACH compliant according to 1907/2006/EC (Registration, Evaluation, Authorisation and Restriction of Chemicals)
- RoHS compliant according to 2002/95/EC (Restrictions of the Use of Hazardous Substances)
- Easily surpassing the requirements of the corrosion protection class K5 (360 hours resistance to white rust / 720 hours resistance to red rust) as defined by the VDMA, the German Engineering Association (VDMA Standard Sheet 24576 „Fluid Power - Requirements and designations for corrosion-protection coatings free of hexavalent chrome“)
- Significantly reduced tendency to corrosion by contact with other metals such as Aluminium and Stainless Steel
- High abrasion resistance due to the ductility / plastic deformability of the coating
- Appealing colour scheme with a bright semi-gloss surface finish – comparable to Stainless Steel
- Surface is paintable with good paint adhesion properties (However, a painting test and, if necessary, degreasing of the surfaces to be painted are highly recommended)
- Little to no risk of triggering allergies, as the Zinc/Nickel base layer with a nickel content of 12-15 % is covered by both a passivation and a sealing layer to avoid the release of nickel and any direct physical contact
- Resistant against all commonly used hydraulic media



Elastomer Seal Materials

Unless otherwise stated, standard elastomer seals are made of NBR (Perbunan®).

Elastomer seals made of NBR (Perbunan® – material code: B) are especially suitable for liquid or gaseous media at operating temperatures that range from **-35 °C to +100 °C**.

Elastomer seals for applications with higher temperatures or aggressive media, such as FKM (Viton® – material code: V – operating temperature range from **-25 °C to +200 °C** and EPDM (material code: E), are available upon request.

Do not hesitate to contact STAUFF for further information.

The performance of elastomer seals during operation can be negatively affected by various influences. Elastomer seals should be inspected for any kind of damage (cracks, deformation, hardening or softening, swelling, reduced elasticity etc.) or contamination prior to the assembly process and when carrying out service and maintenance work, and should be replaced, if necessary.

Spare seals are available as part of the STAUFF Connect range.

Thanks to their zinc/nickel surface coating, STAUFF Connect Tube Connectors made of steel have a high resistance to all common hydraulics fluids, which also applies to contact with other media and aggressive substances.

However, STAUFF still recommends verifying the suitability of media which are not designated as common hydraulics fluids or to contact STAUFF before use if in doubt.

Storage Recommendations

Please observe the following storage recommendations for elastomer seals in accordance with DIN 7716 (Requirements for Storage, Cleaning and Maintenance of Rubber Products):

- Store seals in a dry place, away from draughts, at temperatures not exceeding +25 °C.
- Protect seals from sunlight, ozone and strong artificial lightning during storage.

These recommendations do not only apply for separate elastomer seals, but also for tube fittings with pre-assembled o-rings and seals.

Not following these storage recommendations can cause brittle fracture of elastomer seals and result in leakage!

*Perbunan® is a registered trademark of Lanxess Deutschland GmbH.
Viton® is a registered trademark of DuPont Performance Elastomers L.L.C.*

Overview of media resistance

In addition to the resistance of the STAUFF zinc/nickel surface coatings, compatibility of the elastomers and other hydraulic components also have to be considered.

The following table shows a general overview of this. This is only intended for guidance!

Medium	STAUFF Connect fitting Steel	Sealing material NBR (Buna-N®)	FKM (Viton®)	EPDM
Acetone				
ASTM - oil no. 1				
ASTM - oil no. 2				
ASTM - oil no. 3				
ASTM - oil no. 4				
Petrol				
Benzene				
Brake fluid				
Diesel fuel				
Compressed air (dry, oil-free)				
Natural gas				
Oil/petroleum				
Ethanol (ethyl alcohol)				
Ether				
Liquid gas LPG (propane/butane)				
Gear oil				
Glycol (ethylene glycol)				
Heating oil				
Hydraulic fluids, biodegradable HEES (synthetic esters)	*	*		
Hydraulic fluids, biodegradable HEPG (polyglycol-based)			*	
Hydraulic fluids, flame-resistant HFC (water-glycol)				
Hydraulic oils HL/HLP (mineral oil-based)				
Carbon dioxide				
Carbon monoxide				
Seawater				
Methane				
Methanol (methyl alcohol)				
Mineral oils				
Natural gas, untreated (sour gas)				
Petroleum				
Crude oil				
Soap solution				
Silicone oils				
Skydrol 500				
Skydrol 7000				
Turpentine				
Water (up to 70°)				
Water vapour				

resistant

limited resistance

not resistant

* temperature-dependent



T

Pressure and Temperature Ratings

General Information

Unless otherwise stated, all pressure ratings in this product catalogue are indicated in bar. All temperature ratings are indicated in °C (degree Celsius).

Pressure ratings are usually rounded to correspond with standardised pressure ratings, which are internationally recognised and assist to identify and match common sizes of components together.

All tube fittings and other components of the STAUFF Connect range meet or exceed common standardised pressure ratings for mobile and industrial fluid power applications up to nominal pressures of 800 bar (depending on series, type and size of the component – pressure reduction factors to be considered).

Pressure ratings are divided into nominal pressures (PN) and permissible operating pressures (PB).

Nominal Pressure (PN)

Nominal pressure (PN) is a term used to describe the pressure that tube fittings and other components are designed to safely withstand, and indicates the maximum operating pressure of tube fittings and other components that should be applied to the component when operating the system under stationary conditions.

During static load tests, burst pressures must be at least 4 times higher than the nominal pressures (safety factor of 4).

Permissible Operating Pressure (PB)

The permissible operating pressure (PB) of a component (as defined in DIN 2401, part 1) is identical to the maximum internal overpressure at regular operating conditions (operating temperature of +120 °C without dynamic loads / pressure peaks) as calculated based on the material in use and considering the permissible operating temperature (TB).

During static load tests, burst pressures must be at least 2,5 times higher than the permissible operating pressures (safety factor of 2,5).

Please note:

The pressure ratings and safety factors as specified are only applicable when strictly following the assembly instructions (e.g. tightening torques for male stud fittings) and only refer to original components of the STAUFF Connect range. Avoid mixing with other brands' products!

If components are exposed to vibrations, dynamic loads or pressure peaks, the pressure ratings must be reduced accordingly in order to keep the same level of safety.

Permissible Operating Temperature (TB)

Unless otherwise stated, the permissible operating temperature (TB) for tube fittings and other components in this product catalogue ranges from -20 °C to +120 °C in accordance with DIN 3859-1 (Technical Specification for Tube Fittings).

Please observe that the permissible operating temperature may differ for tube fittings and other components that use elastomer seals. Deviations for tube fittings made of stainless steel see next page.



Pressure Reduction Factors

Pressure reduction factors (in percent) have to be considered when intending to use the components at operating temperatures exceeding +120 °C for steel and +50 °C for stainless steel.

Calculation Example

Component Straight Fitting FI-G-10S-W3-MS made of Steel with a nominal pressure (PN) rating of 800 bar

Temperature +175 °C

Reduction Factor 15 %

Reduced Nominal Pressure $PN = \frac{800 \text{ bar}}{100 \%} \times (100 \% - 15 \%) = 680 \text{ bar}$

Please note:

When selecting tubes and other components for your system, any additional potential pressure reduction factors stated by the manufacturers / suppliers have to be considered.

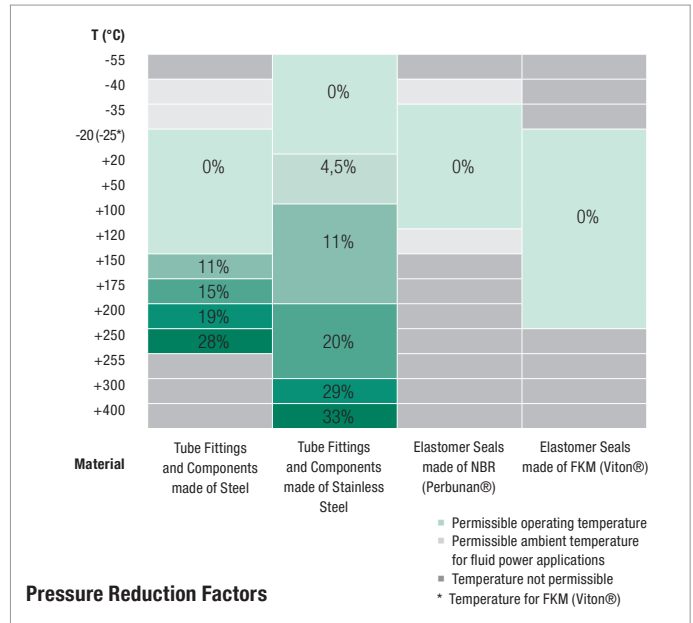

Selection Criteria for Tube

STAUFF generally recommends the use of the following tested and approved Tubes for STAUFF systems.

Permitted Steel Tubes

Seamless cold drawn, normalised precision steel tubes according to DIN EN 10305-4, material E235+N (material number 1.0308+N, formerly St37.4) or material E355 (material number 1.0580, formerly St52.4). In order to avoid misdeliveries, the tubes have to be ordered from the supplier by specifying the exact outer and inner diameter.

Permitted Stainless Steel Tubes

Seamless cold-drawn precision tubes made of stainless steel according to EN 10305-1 in delivery condition CFA or CFD and other delivery conditions according to DIN EN 10216-5 (material 1.4571 / AISI 316 Ti) with a hardness of not more than 90 HRB.

Tube materials and tolerances differing from these recommendations may lead to system faults or leakages and may even result in total breakdowns.

Unless otherwise stated, the pressure / temperature ratings as well as all other operating conditions indicated in this product catalogue do not refer to the actual tube.

Specifications made by the respective tube manufacturers / suppliers have to be considered.



Calculated Design / Burst Pressures for Tube (bar)

Tube OD mm	Tube ID mm	Tube Wall mm	Calculated Design Pressure (bar) in accordance with DIN 2413 - Load Case I (predominantly static loads, up to +120 °C)			Calculated Design Pressure (bar) in accordance with DIN 2413 - Load Case III (dynamic / pulsating loads, up to +120 °C)			Calculated Burst Pressure (bar) in accordance with ISO 10763			STAUFF Nominal pressure Reference pressure for tube fittings bar	
			Material E235+N	Material E355	Material 1.4571	Material E235+N	Material E355	Material 1.4571	Material E235+N	Material E355	Material 1.4571	Light Series	Heavy Series
6	4,5	0,75	338	491	368	303	310	256	1116	1525	1346	500	800
6	4	1	450	655	490	391	400	330	1573	2149	1898	500	800
6	3	1,5	675	983	735	551	563	465	2689	3674	3244	500	800
6*	2	2	900	1310	980	692	708	585	4263	5823	5142	500	800
6*	1,5	2,25	1013	1474	1103	757	774	639	5379	7347	6488	500	800
8	6	1	338	491	368	303	310	256	1116	1525	1346	500	800
8	5	1,5	506	737	551	433	443	366	1824	2491	2200	500	800
8	4	2	675	983	735	551	563	465	2689	3674	3244	500	800
8*	3	2,5	844	1228	919	659	673	556	3806	5198	4590	500	800
10	8	1	270	393	294	248	253	209	866	1183	1044	500	800
10	7	1,5	405	590	441	357	365	301	1384	1890	1669	500	800
10	6	2	540	786	588	458	468	386	1982	2707	2391	500	800
10	5	2,5	675	983	735	551	563	465	2689	3674	3244	500	800
10*	4	3	810	1179	882	638	652	539	3555	4856	4288	500	800
12	10	1	225	328	245	209	214	177	707	966	853	400	630
12	9	1,5	338	491	368	303	310	256	1116	1525	1346	400	630
12	8	2	450	655	490	391	400	330	1573	2149	1898	400	630
12	7	2,5	563	819	613	474	484	400	2091	2857	2523	400	630
12	6	3	675	983	735	551	563	465	2689	3674	3244	400	630
12*	5	3,5	823	1180	858	624	638	527	3397	4640	4097	400	630
12*	4	4	940	1348	980	692	708	585	4263	5823	5142	400	630
14	12	1	193	281	210	181	185	153	598	817	721		630
14	11	1,5	289	421	315	264	270	223	936	1278	1129		630
14	10	2	386	561	420	342	349	289	1306	1783	1575		630
14	9	2,5	482	702	525	415	425	351	1714	2342	2068		630
14	8	3	579	842	613	485	496	410	2171	2966	2619		630
14	7	3,5	705	1011	735	551	563	465	2689	3674	3244		630
15	13	1	180	262	196	170	174	143	555	758	670	400	
15	12	1,5	270	393	294	248	253	209	866	1183	1044	400	
15	11	2	360	524	392	321	329	271	1203	1644	1452	400	
15	10	2,5	450	655	490	391	400	330	1573	2149	1898	400	
15	9	3	540	786	588	458	468	386	1982	2707	2391	400	
16	14	1	169	246	184	160	163	135	518	708	625		630
16	13	1,5	253	368	276	233	239	197	806	1100	972		630
16	12	2	338	491	368	303	310	256	1116	1525	1346		630
16	11	2,5	422	614	459	370	378	312	1454	1986	1754		630
16	10	3	506	737	551	433	443	366	1824	2491	2200		630
16	8	4	705	1011	735	551	563	465	2689	3674	3244		630
18	16	1	150	218	163	143	146	121	457	624	551	400	
18	15	1,5	225	328	245	209	214	177	707	966	853	400	
18	14	2	300	437	327	273	279	230	975	1332	1176	400	
18	13	2,5	375	546	408	333	341	281	1263	1725	1523	400	
18	12	3	450	655	490	391	400	330	1573	2149	1898	400	
18	10	4	627	899	653	500	511	422	2281	3115	2751	400	
20	17	1,5	203	295	221	190	194	160	631	861	761		420
20	16	2	270	393	294	248	253	209	866	1183	1044		420
20	15	2,5	338	491	368	303	310	256	1116	1525	1346		420
20	14	3	405	590	441	357	365	301	1384	1890	1669		420
20	13	3,5	494	708	515	408	417	345	1671	2283	2016		420
20	12	4	564	809	588	458	468	386	1982	2707	2391		420
20	10	5	705	1011	735	551	563	465	2689	3674	3244		420

Load case I according to DIN 2413 describes predominantly static loads at temperatures not exceeding +120 °C.
 Load case III according to DIN 2413 describes dynamic / pulsating loads at temperatures not exceeding +120 °C.

For some sizes of thin-walled steel tube, support sleeves are highly recommended and in some case generally required.
 Please see page G11 for selection charts and detailed assembly instructions.

T

Calculated Design / Burst Pressures for Tube (bar)

Tube OD mm D1	Tube ID mm D2	Tube Wall mm S	Calculated Design Pressure (bar) in accordance with DIN 2413 - Load Case I (predominantly static loads, up to +120 °C)			Calculated Design Pressure (bar) in accordance with DIN 2413 - Load Case III (dynamic / pulsating loads, up to +120 °C)			Calculated Burst Pressure (bar) in accordance with ISO 10763			STAUFF Nominal pressure Reference pressure for tube fittings bar	
			Material E235+N	Material E355	Material 1.4571	Material E235+N	Material E355	Material 1.4571	Material E235+N	Material E355	Material 1.4571	Light Series	Heavy Series
22	20	1	123	179	134	118	121	100	370	505	446	250	
22	19	1,5	184	268	200	173	177	146	569	777	686	250	
22	18	2	245	357	267	227	232	192	779	1064	939	250	
22	17	2,5	307	447	334	278	285	235	1000	1366	1207	250	
22	16	3	368	536	401	328	335	277	1236	1688	1490	250	
22	15	3,5	449	643	468	376	384	317	1486	2030	1792	250	
22	14	4	513	735	535	422	431	356	1754	2396	2115	250	
25	22	1,5	162	236	176	154	157	130	496	678	598		420
25	21	2	216	314	235	201	206	170	676	924	816		420
25	20	2,5	270	393	294	248	253	209	866	1183	1044		420
25	19	3	324	472	353	292	299	247	1065	1455	1284		420
25	18	3,5	395	566	412	336	343	283	1275	1741	1537		420
25	17	4	451	647	470	378	386	319	1496	2044	1805		420
25	16	4,5	508	728	529	418	428	353	1732	2365	2089		420
25	15	5	564	809	588	458	468	386	1982	2707	2391		420
28	25	1,5	145	211	158	138	141	117	440	601	530	250	
28	24	2	193	281	210	181	185	153	598	817	721	250	
28	23	2,5	241	351	263	223	228	188	763	1043	921	250	
28	22	3	289	421	315	264	270	223	936	1278	1129	250	
28	21	3,5	353	506	368	303	310	256	1116	1525	1346	250	
28	20	4	403	578	420	342	349	289	1306	1783	1575	250	
30	26	2	180	262	196	170	174	143	555	758	670		420
30	25	2,5	225	328	245	209	214	177	707	966	853		420
30	24	3	270	393	294	248	253	209	866	1183	1044		420
30	23	3,5	329	472	343	285	291	241	1031	1408	1243		420
30	22	4	376	539	392	321	329	271	1203	1644	1452		420
30	20	5	470	674	490	391	400	330	1573	2149	1898		420
30	18	6	564	809	588	458	468	386	1982	2707	2391		420
35	32	1,5	121	173	126	111	114	94	348	475	419	250	
35	31	2	161	231	168	147	150	124	471	643	568	250	
35	30	2,5	201	289	210	181	185	153	598	817	721	250	
35	29	3	242	347	252	215	220	181	730	997	880	250	
35	27	4	322	462	336	280	286	236	1007	1375	1215	250	
35	25	5	403	578	420	342	349	289	1306	1783	1575	250	
38	34	2	148	213	155	136	139	115	432	589	521		420
38	33	2,5	186	266	193	168	171	142	547	748	660		420
38	32	3	223	319	232	199	203	168	667	911	804		420
38	30	4	297	426	309	260	265	219	917	1253	1106		420
38	28	5	371	532	387	318	325	268	1185	1619	1429		420
38	26	6	445	639	464	373	382	315	1472	2011	1776		420
38	24	7	519	745	542	427	436	360	1783	2436	2151		420
38	22	8	594	851	619	478	488	404	2121	2897	2558		420
42	39	1,5	101	144	105	93	96	79	288	393	347	250	
42	38	2	134	193	140	123	126	104	388	530	468	250	
42	37	2,5	168	241	175	153	156	129	492	672	593	250	
42	36	3	201	289	210	181	185	153	598	817	721	250	
42	34	4	269	385	280	237	242	200	820	1120	989	250	
42	32	5	336	481	350	290	297	245		1441	1273	250	

All figures are based on calculations carried out in accordance with DIN 2413 and ISO 10763.

They are intended to assist the user in the pre-selection of the correct tube only, and do not discharge the obligation to carry out own calculations in consideration of the actual conditions of use.

DIN 2413 does not apply to tube sizes marked by * (where D1/D2 > 2).

T

Port Dimensions for Fittings with Male Threaded Stud

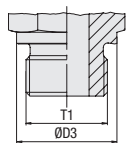

Metallic Sealing Edge

Metric Parallel Thread
DIN 3852-1 (Form B) / ISO 9974-3 (Type B)
Whitworth Parallel Pipe Thread
DIN 3852-2 (Form B) / ISO 1179-4 (Type B)

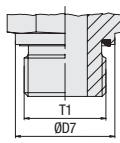

Profile Sealing Ring

Metric Parallel Thread
ISO 9974-2 (Type E)
Whitworth Parallel Pipe Thread
ISO 1179-2 (Type E)

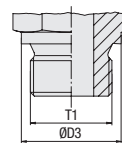

Sealing Surface for Gasket (DIN 7603)

Metric Parallel Thread
DIN 3852-1 (Form A)
Whitworth Parallel Pipe Thread
DIN 3852-2 (Form A)

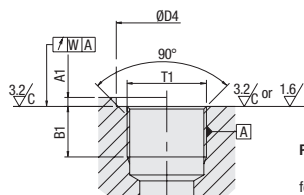

Port (Parallel Thread)

for Male Studs with Metric Parallel Thread
DIN 3852-1 (Form X) / ISO 9974-1
for Male Studs with Whitworth Parallel Pipe Thread
DIN 3852-2 (Form X) / ISO 1179-1

Dimensions

Thread T1 ¹	D3	D7 _{-0,2}	D4 small _{min}	D4 wide _{min}	A1 _{max}	B1 _{min}	W
M 8 x 1	12		13	17	1	8	0,1
M 10 x 1	14	13,9	15	20	1	8	0,1
M 12 x 1,5	17	16,9	18	25	1,5	12	0,1
M 14 x 1,5	19	18,9	20	25	1,5	12	0,1
M 16 x 1,5	21	21,9	23	28	1,5	12	0,1
M 18 x 1,5	23	23,9	25	30	2	12	0,1
M 20 x 1,5	24	25,9	27	34	2	14	0,1
M 22 x 1,5	27	26,9	28	34	2,5	14	0,1
M 26 x 1,5	31	31,9	33	42	2,5	16	0,2
M 27 x 2	32	31,9	33	42	2,5	16	0,2
M 33 x 2	39	39,9	41	47	2,5	18	0,2
M 42 x 2	49	49,9	51	58	2,5	20	0,2
M 48 x 2	55	54,9	56	65	2,5	22	0,2
G 1/8 A	14	13,9	15	19	1	8,5	0,1
G 1/4 A	18	18,9	20	25	1,5	12,5	0,1
G 3/8 A	22	21,9	23	28	2	12,5	0,1
G 1/2 A	26	26,9	28	34	2,5	15	0,1
G 3/4 A	32	31,9	33	42	2,5	16,5	0,2
G 1 A	39	39,9	41	47	2,5	19	0,2
G 1 1/4 A	49	49,9	51	58	2,5	21,1	0,2
G 1 1/2 A	55	54,9	56	65	2,5	22,5	0,2

¹ Appendix A in the thread description does not apply to (female) threaded ports.



Port Dimensions for Fittings with Male Threaded Stud

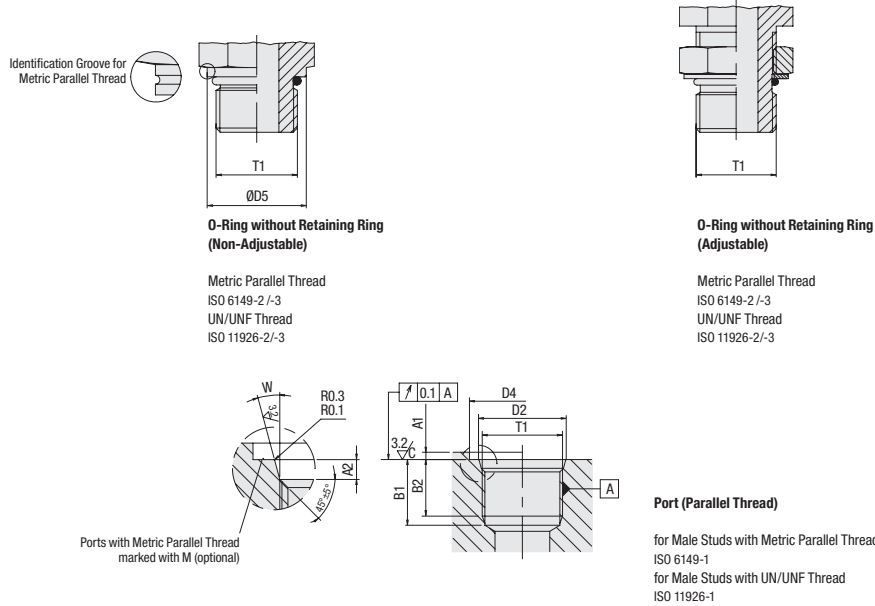

Dimensions

mm										
Thread T1 ¹	D5	D4 small _{min}	D4 wide _{min}	D2 _{+0,1 (UN/UNF: ±0,05)}	A1 _{max}	A2 _{+0,4}	B1 _{min}	B2 _{min}	W _{±1*}	
M 8 x 1	11,8	14	17	9,1	1	1,6	11,5	10	12	
M 10 x 1	13,8	16	20	11,1	1	1,6	11,5	10	12	
M 12 x 1,5	16,8	19	23	13,8	1,5	2,4	14	11,5	15	
M 14 x 1,5	18,8	21	25	15,8	1,5	2,4	14	11,5	15	
M 16 x 1,5	21,8	24	28	17,8	1,5	2,4	15,5	13	15	
M 18 x 1,5	23,8	26	30	19,8	2	2,4	17	14,5	15	
M 22 x 1,5	26,8	29	33	23,8	2	2,4	18	15,5	15	
M 27 x 2	31,8	34	40	29,4	2	3,1	22	19	15	
M 33 x 2	40,8	43	49	35,4	2,5	3,1	22	19	15	
M 42 x 2	49,8	52	58	44,4	2,5	3,1	22,5	19,5	15	
M 48 x 2	54,8	57	63	50,4	2,5	3,1	25	22	15	
7/16-20 UNF-2A	14,4	21		12,45	1,6	2,4	14	11,5	12	
1/2-20 UNF-2A	16	23		14,05	1,6	2,4	14	11,5	12	
9/16-18 UNF-2A	17,6	25		15,7	1,6	2,5	15,5	12,7	12	
3/4-16 UNF-2A	21,8	30		20,65	2,4	2,5	17,5	14,3	15	
7/8-14 UNF-2A	25,5	34		24	2,4	2,5	20	16,7	15	
1 1/16-12 UN-2A	31,9	41		29,2	2,4	3,3	23	19	15	
1 5/16-12 UN-2A	38,2	49		35,55	3,2	3,3	23	19	15	
1 5/8-12 UN-2A	47,7	58		43,55	3,2	3,3	23	19	15	
1 7/8-12 UN-2A	54,8	65		49,9	3,2	3,3	23	19	15	

¹ Appendix -2B instead of -2A applies for (female) threaded ports.

Port Dimensions for Fittings with Male Threaded Stud

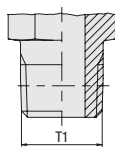

Taper Thread

National Pipe Thread (NPT)
ANSI/ASME B1.20.1-1983

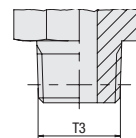

Taper Thread

Metric Taper Thread
DIN 3852-1 (Form C)
Whitworth Taper Pipe Thread
DIN 3852-2 (Form C)

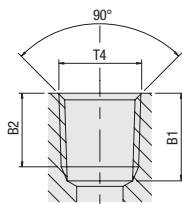

Port (Taper Thread)

for Male Studs with National Pipe NPT Thread
ANSI/ASME B1.20.1-1983

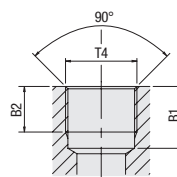

Port (Parallel Thread)

for Male Studs with Metric Taper Thread
DIN 3852-1 (Form Z)
for Male Studs with Whitworth Taper Pipe Thread
DIN 3852-2 (Form Z)

Dimensions

mm				
Thread T1	Thread T3	Thread T4	B1 _{min}	B2 _{min}
1/8-27 NPT		1/8-27 NPT		6,9
1/4-18 NPT		1/4-18 NPT		10
3/8-18 NPT		3/8-18 NPT		10,3
1/2-14 NPT		1/2-14 NPT		13,6
3/4-14 NPT		3/4-14 NPT		14,1
1-11.5 NPT		1-11.5 NPT		16,8
1 1/4-11.5 NPT		1 1/4-11.5 NPT		17,3
1 1/2-11.5 NPT		1 1/2-11.5 NPT		17,3
	M 8 x 1 keg.	M 8 x 1	10	5,5
	M 10 x 1 keg.	M 10 x 1	10	5,5
	M 12 x 1,5 keg.	M 12 x 1,5	13,5	8,5
	M 14 x 1,5 keg.	M 14 x 1,5	13,5	8,5
	M 16 x 1,5 keg.	M 16 x 1,5	13,5	8,5
	M 18 x 1,5 keg.	M 18 x 1,5	13,5	8,5
	M 20 x 1,5 keg.	M 20 x 1,5	15,5	10,5
	M 22 x 1,5 keg.	M 22 x 1,5	15,5	10,5
	R 1/8 keg.	Rp 1/8	8,5	5,5
	R 1/4 keg.	Rp 1/4	12,5	8,5
	R 3/8 keg.	Rp 3/8	12,5	8,5
	R 1/2 keg.	Rp 1/2	16,5	10,5

Suitable liquid / plastic sealant required to achieve leak-tightness.



Dimensions of the 24° Conical Bore / Union Nut

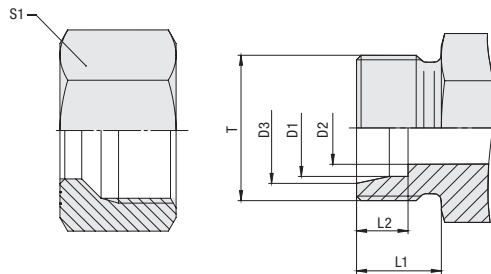

Series	Tube OD		Dimensions						
	mm	mm	mm						
	D1	Thread T	D2	D3	L1	L2	S1		
LL	4	M 8 x 1	3	5	8	4	10		
	6	M 10 x 1	4,5	7,5	8	5,5	12		
	8	M 12 x 1	6	9,5	9	5,5	14		
L	6	M 12 x 1,5	4	8,1	10	7	14		
	8	M 14 x 1,5	6	10,1	10	7	17		
	10	M 16 x 1,5	8	12,3	11	7	19		
	12	M 18 x 1,5	10	14,3	11	7	22		
	15	M 22 x 1,5	12	17,3	12	7	27		
	18	M 26 x 1,5	15	20,3	12	7,5	32		
	22	M 30 x 2	19	24,3	14	7,5	36		
	28	M 36 x 2	24	30,3	14	7,5	41		
	35	M 45 x 2	30	38	16	10,5	50		
S	6	M 14 x 1,5	4	8,1	12	7	17		
	8	M 16 x 1,5	5	10,1	12	7	19		
	10	M 18 x 1,5	7	12,3	12	7,5	22		
	12	M 20 x 1,5	8	14,3	12	7,5	24		
	14 ¹	M 22 x 1,5	10	16,3	14	8	27		
	16	M 24 x 1,5	12	18,3	14	8,5	30		
	20	M 30 x 2	16	22,9	16	10,5	36		
	25	M 36 x 2	20	27,9	18	12	46		
	30	M 42 x 2	25	33	20	13,5	50		
	38	M 52 x 2	32	41	22	16	60		

¹ Tube size is no longer covered by the applicable standard.

Standard Threads and Widths Across Flats for Fittings with Male Threaded Stud

Series	Tube OD mm D1	Male Stud		Male Stud		Union Nut	
		Metric Parallel Thread Thread Size	Width Across Flats	Whitworth Parallel Pipe Thread Thread Size	Width Across Flats	Metric Parallel Thread Thread Size	Width Across Flats
L	6	M 10 x 1	14	G 1/8	14	M 12 x 1,5	14
	8	M 12 x 1,5	17	G 1/4	19	M 14 x 1,5	17
	10	M 14 x 1,5	19	G 1/4	19	M 16 x 1,5	19
	12	M 16 x 1,5	22	G 3/8	22	M 18 x 1,5	22
	15	M 18 x 1,5	24	G 1/2	27	M 22 x 1,5	27
	18	M 22 x 1,5	27	G 1/2	27	M 26 x 1,5	32
	22	M 26 x 1,5 ²	32	G 3/4	32	M 30 x 2	36
	28	M 33 x 2	41	G 1	41	M 36 x 2	41
	35	M 42 x 2	50	G 1 1/4	50	M 45 x 2	50
	42	M 48 x 2	55	G 1 1/2	55	M 52 x 2	60
S	6	M 12 x 1,5	17	G 1/4	19	M 14 x 1,5	17
	8	M 14 x 1,5	19	G 1/4	19	M 16 x 1,5	19
	10	M 16 x 1,5	22	G 3/8	22	M 18 x 1,5	22
	12	M 18 x 1,5	24	G 3/8	22	M 20 x 1,5	24
	14 ¹	M 20 x 1,5	27	G 1/2	27	M 22 x 1,5	27
	16	M 22 x 1,5	27	G 1/2	27	M 24 x 1,5	30
	20	M 27 x 2	32	G 3/4	32	M 30 x 2	36
	25	M 33 x 2	41	G 1	41	M 36 x 2	46
	30	M 42 x 2	50	G 1 1/4	50	M 42 x 2	50
	38	M 48 x 2	55	G 1 1/2	55	M 52 x 2	60

¹ Tube size is no longer covered by the applicable standard.

² M 27 x 2 according to ISO 6149.



Certificates and Approvals

Our in-house laboratories carry out constant checks and tests in line with international standards on all STAUFF products. Certified in accordance with ISO 9001, ISO 14001, OHSAS 18001 and ISO 50001, the STAUFF quality assurance system continually strives for perfection.

The QA system encompasses both product quality, which is driven by customer requirements, and all related services. The QA focuses on the expectations of all partners involved. Quality management at STAUFF is a dynamic process that is checked on a daily basis to ensure that continuous improvements are made.

Please note:

All named approvals and certificates refer to certain products and designs, as well as to the application.

STAUFF is tuned in to the needs of the global market and this, together with the benefit of an experienced and highly motivated team of employees and the use of innovative technology, enables the company to offer a sophisticated product range which will satisfy the requirements of each and every customer worldwide.

The validity of the approvals will be continuously extended at the approval offices after expiry. Details, such as the period of validity, can be found in the respective certificates.

The most common STAUFF Connect Tube Fittings have received certifications and approvals from various international institutes, organisations and authorities who have independently confirmed the quality and performance of the products:

- Bureau Veritas
- DNV - GL
- DVGW
- Lloyd's Register

Please contact STAUFF for further approvals.

Please find a current version of the approvals and certificates at: www.stauff.com/certificates



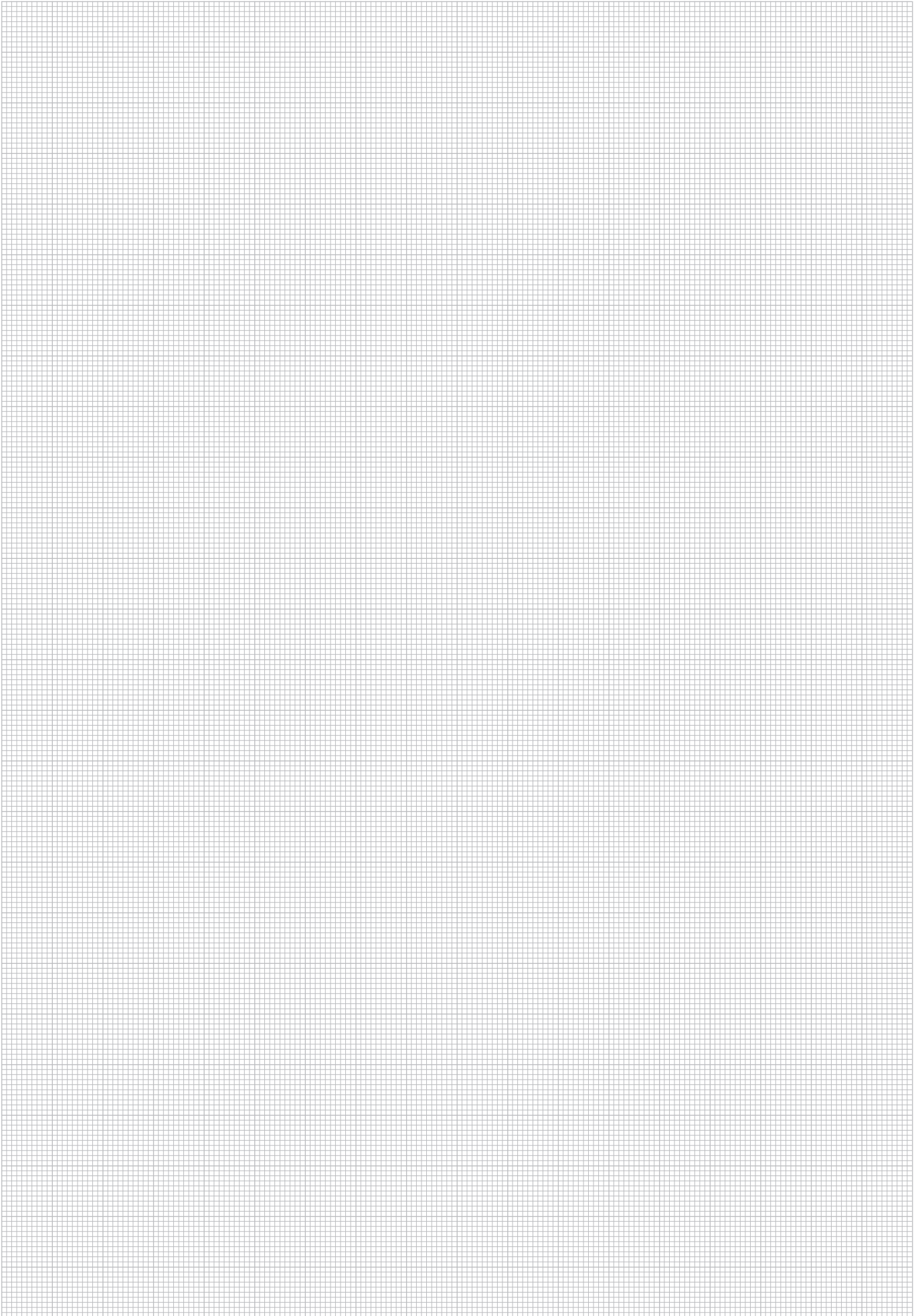

T



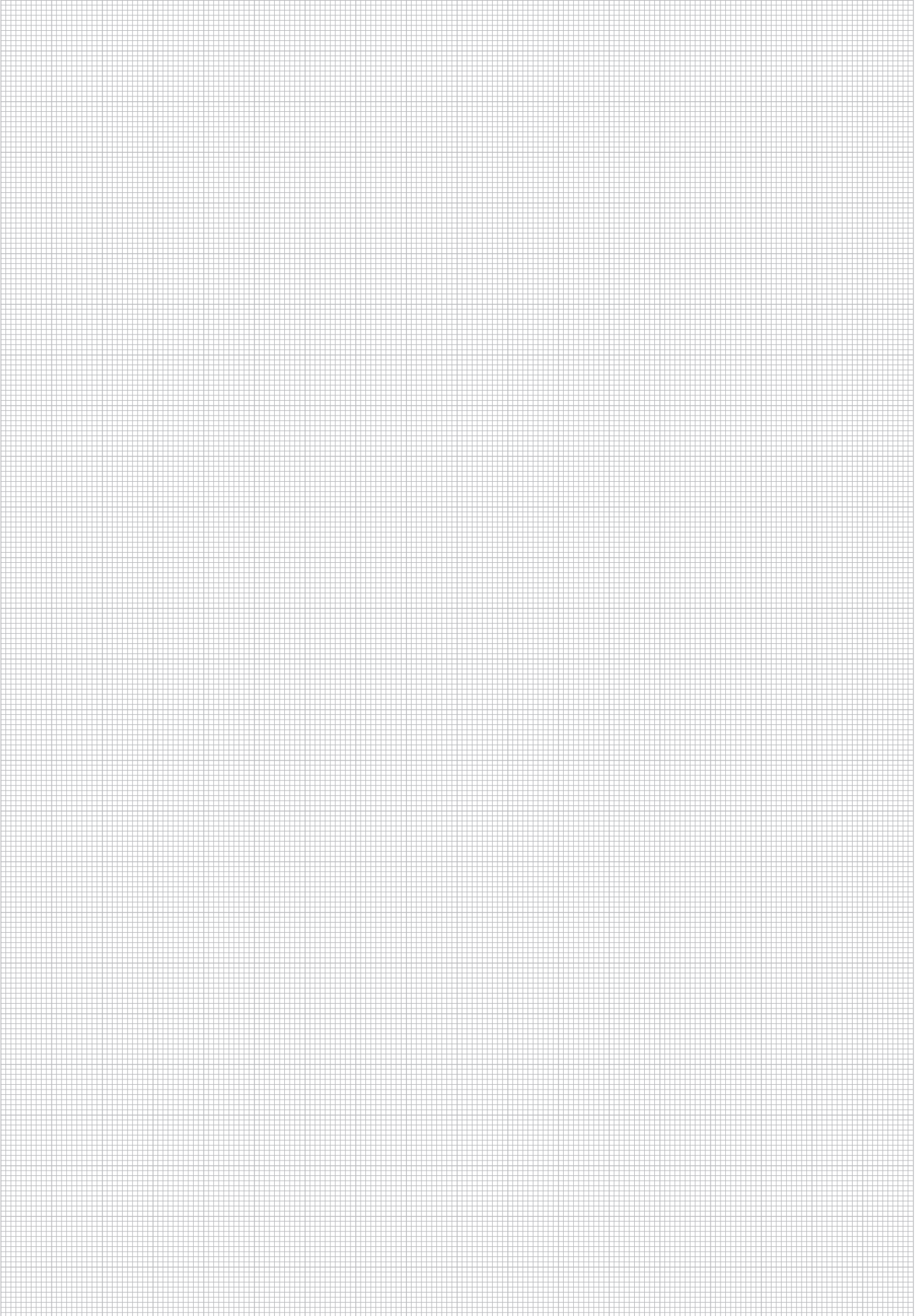

T





Product-Specific Abbreviations	346
Global Contact Directory	350



Product-Specific Abbreviations

Abbreviation	Product Category	Product Description	Page
FI-AB	Connecting Parts	37° Flared Tube Fitting Set	37
FI-AS	Weld Fittings	Straight Weld Fitting	114
FI-ASV	Weld Fittings	Straight Weld Fitting for Tubes	120
FI-BA	Connecting Parts	24°/37° Flared Cone Adaptor with O-Rings	34
FI-BH	Connecting Parts	Support Sleeve for 37° Flared Tube Fittings	35
FI-BM	Connecting Parts	Union Nut for 37° Flared Tube Fittings	36
FI-Box-... (FI-KOL-...)	Measuring and Test Equipment	Cone Gauge Kit	277
FI-BUZ	Spare Parts / Accessories	Blanking Plug with Sealing Edge	235
FI-DGWE-...-M-WD	Swivel Fittings	Swivel Elbow	197
FI-DGWE-...-R-WD	Swivel Fittings	Swivel Elbow	196
FI-DIR	Spare Parts / Accessories	Retaining Ring with Captive Seal for Male Studs of Banjo Fittings	245
FI-DKI	Spare Parts / Accessories	Internal Metallic Sealing Ring for Female Studs of Gauge Fittings	246
FI-DKR	Spare Parts / Accessories	External Metallic Sealing Ring for Male Studs of Banjo Fittings	244
FI-DS	Connecting Parts	Double-Edge Cutting Ring	28
FI-EGE-...-M	Standpipe Fittings	Straight Male Stud Standpipe Fitting	157
FI-EGE-...-M-WD	Standpipe Fittings	Straight Male Stud Standpipe Fitting	160
FI-EGE-...-N	Standpipe Fittings	Straight Male Stud Standpipe Fitting	161
FI-EGE-...-R	Standpipe Fittings	Straight Male Stud Standpipe Fitting	156
FI-EGE-...-R-WD	Standpipe Fittings	Straight Male Stud Standpipe Fitting	158
FI-EGED-...-M-WD	Fittings with 24° Taper / O-Ring (DKO)	Straight Male Stud Fitting with 24° Taper / O-Ring	136
FI-EGED-...-N	Fittings with 24° Taper / O-Ring (DKO)	Straight Male Stud Fitting with 24° Taper / O-Ring	137
FI-EGED-...-R-WD	Fittings with 24° Taper / O-Ring (DKO)	Straight Male Stud Fitting with 24° Taper / O-Ring	134
FI-EL	Standpipe Fittings	Adjustable Standpipe Barrel Tee	168
FI-ELD	Fittings with 24° Taper / O-Ring (DKO)	Adjustable Barrel Tee with 24° Taper / O-Ring (DKO)	153
FI-EMA-...-R	Female Stud / Gauge Fittings	Gauge Standpipe Fitting	131
FI-EMAD-...-R	Female Stud / Gauge Fittings	Gauge Fitting with 24° Taper / O-Ring	130
FI-ES	Bulkhead Fittings	Straight Bulkhead Weld Fitting	110
FI-ET	Standpipe Fittings	Adjustable Standpipe Branch Tee	167
FI-ETD	Fittings with 24° Taper / O-Ring (DKO)	Adjustable Branch Tee with 24° Taper / O-Ring (DKO)	152
FI-EVD	Fittings with 24° Taper / O-Ring (DKO)	Adjustable Elbow (45°) with 24° Taper / O-Ring	151
FI-EW	Standpipe Fittings	Adjustable Standpipe Elbow	166
FI-EWD	Fittings with 24° Taper / O-Ring (DKO)	Adjustable Elbow (90°) with 24° Taper / O-Ring	150
FI-FB	Assembly Tools / Devices	Clamping Jaws	275
FI-FD	Connecting Parts	STAUFF Form EVO Sealing Ring	32
FI-FK	Assembly Tools / Devices	Final Assembly Stud for the Manual Cutting Ring Assembly	270
FI-FST	Assembly Tools / Devices	Tube Shapers	274
FI-G	Tube Fittings / Unions	Straight Union	96
FI-G	Tube Fittings / Unions	Straight Reducer	97
FI-GA-...-M	Female Stud / Gauge Fittings	Straight Female Stud Fitting	126
FI-GA-...-N	Female Stud / Gauge Fittings	Straight Female Stud Fitting	127
FI-GA-...-R	Female Stud / Gauge Fittings	Straight Female Stud Fitting	124
FI-GE-...-M	Male Stud Fittings	Straight Male Stud Fitting	44
FI-GE-...-Mk	Male Stud Fittings	Straight Male Stud Fitting	64
FI-GE-...-M-OR	Male Stud Fittings	Straight Male Stud Fitting	57
FI-GE-...-M-WD	Male Stud Fittings	Straight Male Stud Fitting	52
FI-GE-...-N	Male Stud Fittings	Straight Male Stud Fitting	65
FI-GE-...-R	Male Stud Fittings	Straight Male Stud Fitting	40
FI-GE-...-R-DF	Male Stud Fittings	Straight Male Stud Fitting	55
FI-GE-...-Rk	Male Stud Fittings	Straight Male Stud Fitting	60
FI-GE-...-R-WD	Male Stud Fittings	Straight Male Stud Fitting	48
FI-GE-...-U	Male Stud Fittings	Straight Male Stud Fitting	70
FI-GP	Assembly Tools / Devices	Support Plate for Machine-Assisted Assembly	253
FI-GP-PRC	Assembly Tools / Devices	Support Plate for Machine-Assisted Cutting Ring Assembly	260/268
FI-GS	Bulkhead Fittings	Straight Bulkhead Fitting	108
FI-ID	Assembly Tools / Devices	Internal Tube Supports	274
FI-K	Tube Fittings / Unions	Equal Cross	104
FI-KB	Assembly Tools / Devices	Clamping Jaws for 37° Tube Flaring	261
FI-KR	Spare Parts / Accessories	Retaining Ring (Small) for Male Studs of Fittings with Lock Nut	247
FI-LE-...-M	Male Stud Fittings	Male Stud Barrel Tee	89
FI-LE-...-Mk	Male Stud Fittings	Male Stud Barrel Tee	91
FI-LE-...-N	Male Stud Fittings	Male Stud Barrel Tee	92
FI-LE-...-R	Male Stud Fittings	Male Stud Barrel Tee	88
FI-LE-...-Rk	Male Stud Fittings	Male Stud Barrel Tee	90
FI-LEE-...-M-OK	Fittings with Lock Nut	Adjustable Male Stud Barrel Tee with Lock Nut	175
FI-LEE-...-M-OR	Fittings with Lock Nut	Adjustable Male Stud Barrel Tee with Lock Nut	177
FI-LEE-...-R-OK	Fittings with Lock Nut	Adjustable Male Stud Barrel Tee with Lock Nut	173
FI-LEE-...-U	Fittings with Lock Nut	Adjustable Male Stud Barrel Tee with Lock Nut	179
FI-M	Connecting Parts	Union Nut	33
FI-MA-...-R	Female Stud / Gauge Fittings	Gauge Fitting	129
FI-MFK	Assembly Tools / Devices	Cutting Ring Assembly Stud for Machine-Assisted Assembly	252/259
FI-MFK	Assembly Tools / Devices	Cutting Ring Assembly Stud for Machine-Assisted Assembly	267
FI-MVK-PRC-H-M	Assembly Tools / Devices	Cutting Ring Assembly Stud for Machine-Assisted Assembly	264
FI-RED-...-R	Spare Parts / Accessories	Thread Reducer	226
FI-RED-...-R-WD	Spare Parts / Accessories	Thread Reducer	224
FI-REDS	Standpipe Fittings	Straight Standpipe Reducer	162
FI-RESD	Fittings with 24° Taper / O-Ring (DKO)	Straight Reducer for Tube Ends with 24° Taper / O-Ring	144
FI-RESD	Fittings with 24° Taper / O-Ring (DKO)	Distance Adaptors with 24° Taper / O-Ring	148
FI-RST-...-M-DK	Banjo Fittings	Banjo Tee (High-Pressure Version)	191
FI-RST-...-M-WD	Banjo Fittings	Banjo Tee (High-Pressure Version)	193



Product-Specific Abbreviations

Abbreviation	Product Category	Product Description	Page
FI-RST-...-R-DK	Banjo Fittings	Banjo Tee (High-Pressure Version)	190
FI-RST-...-R-WD	Banjo Fittings	Banjo Tee (High-Pressure Version)	192
FI-RSW-...-M-DK	Banjo Fittings	Banjo Elbow (High-Pressure Version)	187
FI-RSW-...-M-WD	Banjo Fittings	Banjo Elbow (High-Pressure Version)	189
FI-RSW-...-R-DK	Banjo Fittings	Banjo Elbow (High-Pressure Version)	186
FI-RSW-...-R-WD	Banjo Fittings	Banjo Elbow (High-Pressure Version)	188
FI-RSWND-...-M-DK	Banjo Fittings	Banjo Elbow (Medium-Pressure Version)	183
FI-RSWND-...-M-WD	Banjo Fittings	Banjo Elbow (Medium-Pressure Version)	185
FI-RSWND-...-R-DK	Banjo Fittings	Banjo Elbow (Medium-Pressure Version)	182
FI-RSWND-...-R-WD	Banjo Fittings	Banjo Elbow (Medium-Pressure Version)	184
FI-RV	Hydraulic Valves	Check Valve	200
FI-RVA	Hydraulic Valves	Check Valve	201
FI-RVI-...-R	Hydraulic Valves	Female Stud Check Valve	210
FI-RVIA-...-R	Hydraulic Valves	Female Stud Check Valve	211
FI-RVV-...-M-WD	Hydraulic Valves	Male Stud Check Valve	203
FI-RVV-...-R-WD	Hydraulic Valves	Male Stud Check Valve	202
FI-RVVA-...-M-WD	Hydraulic Valves	Male Stud Check Valve	205
FI-RVVA-...-R-WD	Hydraulic Valves	Male Stud Check Valve	204
FI-RVZ-...-M-WD	Hydraulic Valves	Male Stud Check Valve	207
FI-RVZ-...-R-WD	Hydraulic Valves	Male Stud Check Valve	206
FI-RVZA-...-M-WD	Hydraulic Valves	Male Stud Check Valve	209
FI-RVZA-...-R-WD	Hydraulic Valves	Male Stud Check Valve	208
FI-S	Connecting Parts	Single-Edge Cutting Ring	28
FI-SKM	Spare Parts / Accessories	Hexagon Lock Nut	237
FI-SN	Weld Fittings	24° Weld Cone with O-Ring	116
FI-SNR	Weld Fittings	24° Weld Cone Reducer with O-Ring	118
FI-SNV	Fittings with 24° Taper / O-Ring (DKO)	Straight Male Stud Fitting with 24° Taper / O-Ring	138
FI-SNV	Fittings with 24° Taper / O-Ring (DKO)	Straight Reducer with 24° Taper / O-Ring	140
FI-T	Tube Fittings / Unions	Equal Tee	100
FI-T	Tube Fittings / Unions	Tee Reducer	101
FI-TE-...-M	Male Stud Fittings	Male Stud Branch Tee	83
FI-TE-...-Mk	Male Stud Fittings	Male Stud Branch Tee	85
FI-TE-...-N	Male Stud Fittings	Male Stud Branch Tee	86
FI-TE-...-R	Male Stud Fittings	Male Stud Branch Tee	82
FI-TE-...-Rk	Male Stud Fittings	Male Stud Branch Tee	84
FI-TEE-...-M-OK	Fittings with Lock Nut	Adjustable Male Stud Branch Tee with Lock Nut	175
FI-TEE-...-M-OR	Fittings with Lock Nut	Adjustable Male Stud Branch Tee with Lock Nut	177
FI-TEE-...-R-OK	Fittings with Lock Nut	Adjustable Male Stud Branch Tee with Lock Nut	173
FI-TEE-...-U	Fittings with Lock Nut	Adjustable Male Stud Branch Tee with Lock Nut	179
FI-TIB	Measuring and Test Equipment	Thread Identification Board	276
FI-VD	Spare Parts / Accessories	Blanking Plug with 24° Taper / O-Ring (DKO)	234
FI-VEE-...-M-OK	Fittings with Lock Nut	Adjustable Male Stud Elbow (45°) with Lock Nut	175
FI-VEE-...-M-OR	Fittings with Lock Nut	Adjustable Male Stud Elbow (45°) with Lock Nut	177
FI-VEE-...-R-OK	Fittings with Lock Nut	Adjustable Male Stud Elbow (45°) with Lock Nut	173
FI-VEE-...-U	Fittings with Lock Nut	Adjustable Male Stud Elbow (45°) with Lock Nut	179
FI-VES	Hydraulic Valves	Check Valve Installation Kit	212
FI-VH	Connecting Parts	Support Sleeve	31
FI-VK	Assembly Tools / Devices	Pre-Assembly Stud for the Manual Cutting Ring Assembly	271
FI-VS-...-M-OR	Spare Parts / Accessories	Blanking Screw for Ports	233
FI-VS-...-M-WD	Spare Parts / Accessories	Blanking Screw for Ports	231
FI-VS-...-R	Spare Parts / Accessories	Blanking Screw for Ports	232
FI-VS-...-R-WD	Spare Parts / Accessories	Blanking Screw for Ports	230
FI-VSK	Spare Parts / Accessories	Blanking Plug for Tube Ends	236
FI-VSV-...-M-WD	Spare Parts / Accessories	Blanking Screw for Ports (Heavy Duty)	229
FI-VSV-...-R-WD	Spare Parts / Accessories	Blanking Screw for Ports (Heavy Duty)	228
FI-W	Tube Fittings / Unions	Straight Reducer	99
FI-WAS	Weld Fittings	Elbow Weld Fitting	115
FI-WDDS	Connecting Parts	Soft-Sealing Cutting Ring	29
FI-WDDS-W5	Connecting Parts	Soft-Sealing Cutting Ring (Stainless Steel)	30
FI-WE-...-M	Male Stud Fittings	Male Stud Elbow	75
FI-WE-...-Mk	Male Stud Fittings	Male Stud Elbow	78
FI-WE-...-N	Male Stud Fittings	Male Stud Elbow	80
FI-WE-...-R	Male Stud Fittings	Male Stud Elbow	74
FI-WE-...-Rk	Male Stud Fittings	Male Stud Elbow	76
FI-WEE-...-M-OK	Fittings with Lock Nut	Adjustable Male Stud Elbow (90°) with Lock Nut	174
FI-WEE-...-M-OR	Fittings with Lock Nut	Adjustable Male Stud Elbow (90°) with Lock Nut	176
FI-WEE-...-R-OK	Fittings with Lock Nut	Adjustable Male Stud Elbow (90°) with Lock Nut	172
FI-WEE-...-U	Fittings with Lock Nut	Adjustable Male Stud Elbow (90°) with Lock Nut	178
FI-WS	Bulkhead Fittings	Elbow Bulkhead Fittings	109
FI-WV	Hydraulic Valves	Alternating Valve	213
Oel-Stauff-Form-1L	Assembly Tools / Devices	STAUFF Form EVO Oel	276
O-RING	Spare Parts / Accessories	O-Ring for Male Studs	239
O-RING	Spare Parts / Accessories	O-Ring for 24°/37° Flared Cone Adaptors	240
O-RING	Spare Parts / Accessories	O-Ring for for DKO Taper Fittings / 24° Weld Cones	242
O-RING	Spare Parts / Accessories	O-Ring for Banjo Bolts of Banjo Fittings	243
SFO/PRC-POC-FS	Assembly Tools / Devices	External Foot Control Switch	254/276
SFO-F-A-A-IOT	Assembly Tools / Devices	Tube Forming Machine with Cloud connection	272
SPR-PRC-FS	Assembly Tools / Devices	External Foot Control Switch	258
SPR-PRC-H-M-OS	Assembly Tools / Devices	STAUFF Oil with brush	276



Product-Specific Abbreviations

Abbreviation	Product Category	Product Description	Page
SPR-PRC-H-E-SET	Assembly Tools / Devices	Portable Cutting Ring Assembly Machine with Manual Pressure Setting (Set)	262
SPR-PRC-MA-D-A	Assembly Tools / Devices	Combined Cutting Ring Assembly and 37° Tube Flaring Machine	256
SPR-PRC-MP	Assembly Tools / Devices	Manual Cutting Ring Pre-Assembly Device	266
SPR-PRC-POC-A-A-IOT	Assembly Tools / Devices	Cutting Ring Final Assembly Machine with Cloud connection	250 / 254
SPR-PRC-POC-RTH	Assembly Tools / Devices	Optional tool holder for tubes with small bending radii	254
SPR-PRC-TH-C-M	Assembly Tools / Devices	Tooling Head for Cutting Ring Assembly (based on manual settings)	258
SPR-PRC-TH-C-MA	Assembly Tools / Devices	Tooling Head for Cutting Ring Assembly (based on pre-defined settings)	258
SPR-PRC-TH-F-M	Assembly Tools / Devices	Tooling Head for 37° Tube Flaring (based on manual settings)	258
SPR-TM	Assembly Tools / Devices	Assembly Tool Magazine	254/258
STAUFF CLEAN	Tube Manipulation	Pipe, Tube and Hose Cleaning System	280
TUB-MA	Tube Manipulation	Manual Tube Bender	282
TUBSD-MA	Tube Manipulation	Tube Bending and Saw Device	283
TUD-MA	Tube Manipulation	Tube Reamer	285
TUSD-MA	Tube Manipulation	Tube Saw Device	284
WDG	Spare Parts / Accessories	Profile Sealing Ring for Male Studs	238
WDG	Spare Parts / Accessories	Profile Sealing Ring for Male Studs	238



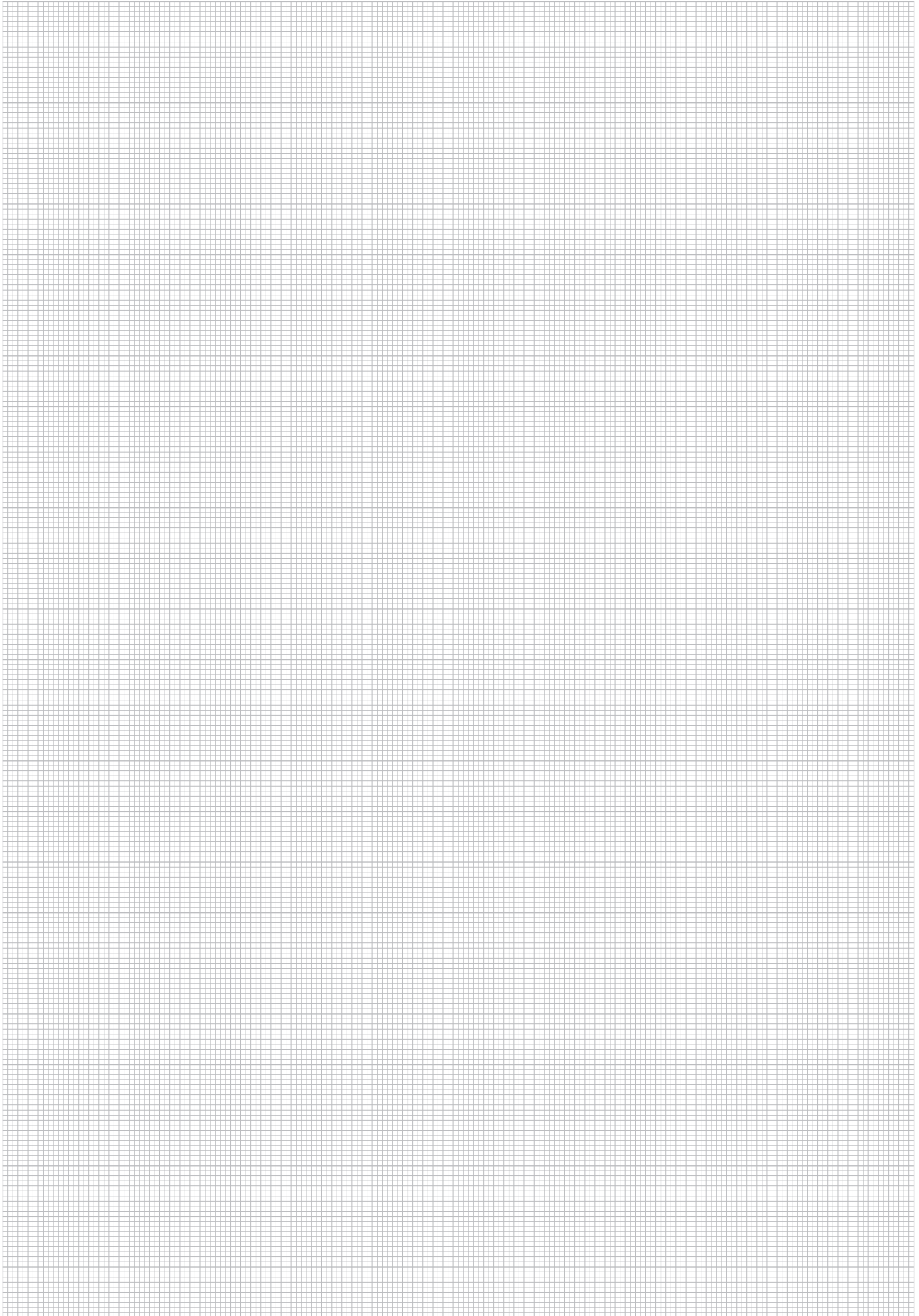

Global Contact Directory

STAUFF products and services are globally available through wholly-owned subsidiaries and a tight network of authorised distributors and representatives in all major industrial regions of the world.

Contact information on this page may be subject to changes and additions over time. Frequently updated and complete contact information can always be found at www.stauff.com.

Germany



Walter Stauffenberg GmbH & Co. KG
Im Ehrenfeld 4
58791 Werdohl
www.stauff.com/contact

www.stauff.com



Neuenrade-Küntrop Logistics Centre
Wasserburgstraße 35
58809 Neuenrade



Plettenberg-Ohle Production Site
Lennastraße 2
58840 Plettenberg



Meinerzhagen Production Site
Neugrünenthal
58540 Meinerzhagen



Meinerzhagen Production Site
Am Rottland 7
58540 Meinerzhagen



STAUFF Digital
Phoenixplatz 3
44263 Dortmund

Europe

France

STAUFF S.A.S.
230, Avenue du Grain d'Or
Z.I. de Vineuil - Blois Sud
41354 Vineuil-cedex
Tel.: +33 2 54 50 55 50
Fax: +33 2 54 42 29 19
E-Mail: direction@stauffsa.com
www.stauff.fr

Ireland

STAUFF UK Ltd.
Block B, 9 Ferguson Drive
Knockmore Hill Industrial Estate
Lisburn, County Antrim, BT28 2EX
Tel.: +44 2892 60 69 00
Fax: +44 2892 60 26 88
E-Mail: sales@stauffireland.com
www.stauff.co.uk

Italy

STAUFF Italia s.r.l
Via Como, 9
23846 Garbagnate Monastero (LC)
Tel.: +39 031 65 84 94
Fax: +39 031 65 50 05
E-Mail: sales@stauff.it
www.stauff.it

Poland

STAUFF Polska Sp. z o.o.
Miszewko 43 A
80-297 Banino
Tel.: +48 58 660 11 60
Fax: +48 58 629 79 52
E-Mail: sales@stauff.pl
www.stauff.pl

Russian Federation

STAUFF LLC
Building 1
19, Leninskaya Sloboda
Moscow, 115280
Tel.: +7 495 276 16 50
Fax: +7 495 276 16 51
E-Mail: sales@stauff.ru
www.stauff.ru

United Kingdom

STAUFF UK Ltd.
500, Carlisle Street East
Off Downgate Drive
Sheffield, S4 8BS
Tel.: +44 114 251 85 18
Fax: +44 114 251 85 19
E-Mail: sales@stauff.co.uk
www.stauff.co.uk

STAUFF UK Ltd.
Badentoy Avenue
Badentoy Industrial Estate
Portlethen, Aberdeen, AB12 4YB
Tel.: +44 1224 78 61 66
Fax: +44 1224 78 61 77
E-Mail: sales@stauffscotland.co.uk
www.stauff.co.uk

Further branch offices in
Engels, Volzhskiy, Magnitogorsk,
Nizhny Novgorod and St. Petersburg.



Global Contact Directory

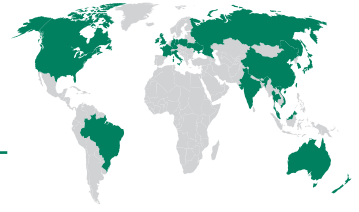

North America

Canada

STAUFF Canada Ltd.
866 Milner Avenue
Scarborough
Ontario M1B 5N7
Tel.: +1 416 282 46 08
Fax: +1 416 282 30 39
E-Mail: sales@stauffcanada.com
www.stauffcanada.com

United States

STAUFF Corporation
7 Wm. Demarest Place
Waldwick, 07463-1542
New Jersey
Tel.: +1 201 444 78 00
Fax: +1 201 444 78 52
E-Mail: sales@stauffusa.com
www.stauffusa.com

Further branch office in
Canton, Michigan.

South America

Brazil

STAUFF Brasil Ltda.
Avenida Gupê 10767
Galpão 2 - Bloco A
Barueri, São Paulo, CEP 06422-120
Tel.: +55 11 47 72 72 00
Fax: +55 11 47 72 72 10
E-Mail: stauff@stauffbrasil.com
www.stauffbrasil.com

Asia

China

STAUFF CHINA
Building 8, No. 1698, Minyi Road
Songjiang District,
Shanghai, 201612
Tel.: +86 21 68 18 70 00
Fax: +86 21 68 18 71 36
E-Mail: info@stauff.com.cn
www.stauff.com.cn

Further branch offices in Beijing,
Changsha, Chengdu, Changchun,
Chongqing, Jinan, Harbin, Guangzhou,
Shenyang, Wuhan, Xian and Xuzhou.

India

STAUFF India Pvt. Ltd.
Gat no. 26/1 & 27, Sanghar Warehousing
Pune - Nagar Road
Lonikand - 412216
Tel.: +91 20 6731 4900
Fax: +91 20 6731 4905
E-Mail: sales@stauffindia.com
www.stauffindia.com

Korea

STAUFF Korea Ltd.
105, Hwajeonsandan 5-ro
Gangseo-gu
Busan, 46739
Tel.: +82 51 266 6666
Fax: +82 51 266 8866
E-Mail: info@stauff.co.kr
www.stauff.co.kr

Singapore

STAUFF (SEA) Pte. Ltd.
128 Joo Seng Road #02-01
Singapore 368356
Tel.: +65 62 44 61 68
E-Mail: sales_sg@stauff.com
www.stauff.com.sg

Thailand

STAUFF (Thailand) Co., Ltd.
10 Soi On-Nut 74/4
Pravet District
Bangkok 10250
Tel.: +66 2 721 73 23 / 24
Fax: +66 2 721 73 35
E-Mail: sales@stauff.co.th
www.stauff.co.th

Vietnam

STAUFF Vietnam Ltd.
8th Floor, Quinimex Building
28 Nguyen Thi Dieu
District 3, Ho Chi Minh City
Tel.: +84 8 3948 10 41 / 42
Fax: +84 8 3948 10 44
E-Mail: sales@stauff.com.vn
www.stauff.com.vn

Oceania

Australia

STAUFF Corporation Pty Ltd
24-26 Doyle Avenue
Unanderra NSW 2526
Tel.: +61 2 4271 9000
Fax: +61 2 4271 8432
E-Mail: sales@stauff.com.au
www.stauff.com.au

Further branch offices in
Adelaide, Brisbane, Melbourne
and Sydney.

New Zealand

STAUFF Corporation (NZ) Ltd.
Unit D, 103 Harris Road
East Tamaki, Auckland 2013
Tel.: +64 9 912 1530
Fax: +64 9 912 1531
E-Mail: sales@stauff.co.nz
www.stauff.co.nz



Introduction

System Overview

Connecting Parts

Male Stud Fittings

Tube Fittings / Unions

Bulkhead Fittings

Weld Fittings

Female Stud / Gauge Fittings

Fittings with 24° Taper / O-Ring (DKO)

Standpipe Fittings

Fittings with Lock Nut

Banjo Fittings

Swivel Fittings

Hydraulic Valves

Custom-Designed Solutions

Spare Parts / Accessories

Assembly Tools / Devices

Measuring and Test Equipment

Tube Manipulation

Assembly Instructions

Technical Appendix

Appendix



Catalogue 2 STAUFF Connect

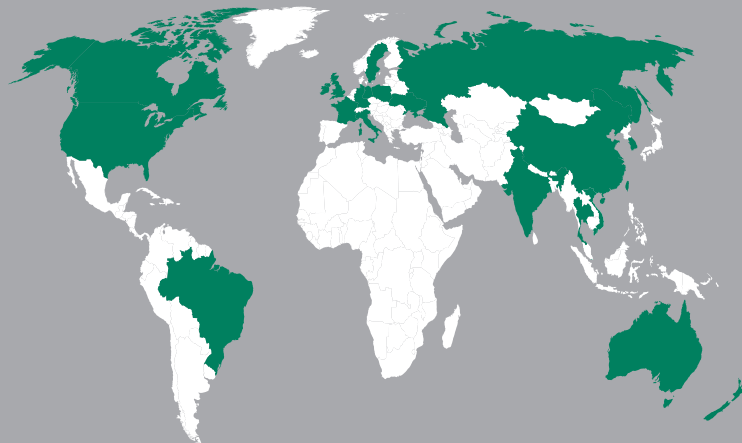

Germany

Walter Stauffenberg GmbH & Co. KG
Im Ehrenfeld 4
58791 Werdohl

STAUFF products and services are globally available through wholly-owned subsidiaries and a tight network of authorised distributors and representatives in all major industrial regions of the world.

Contact STAUFF:

www.stauff.com/contact